



Product designation				Power contactor
Product type designation				BF38
Contact characteristics				
Number of poles	Nr.			3
Rated insulation voltage U_i IEC/EN	V			690
Rated impulse withstand voltage U_{imp}	kV			6
Operational frequency	min	Hz	25	
	max	Hz	400	
IEC Conventional free air thermal current I_{th}	A			56
Operational current I_e	AC-1 ($\leq 40^\circ\text{C}$)	A	56	
	AC-1 ($\leq 40^\circ\text{C}$) with 16mm ² wire and fork end lug	A	60	
	AC-1 ($\leq 55^\circ\text{C}$)	A	45	
	AC-1 ($\leq 55^\circ\text{C}$) with 16mm ² wire and fork end lug	A	48	
	AC-1 ($\leq 70^\circ\text{C}$)	A	40	
	AC-1 ($\leq 70^\circ\text{C}$) with 16mm ² wire and fork end lug	A	42	
	AC-3 ($\leq 440\text{V } \leq 55^\circ\text{C}$)	A	38	
Rated operational power AC-3 ($T \leq 55^\circ\text{C}$)	AC-4 (400V)	A	15.5	
	230V	kW	11	
	400V	kW	18.5	
	415V	kW	18.5	
	440V	kW	18.5	
	500V	kW	20	
	690V	kW	22	
Rated operational power AC-1 ($T \leq 40^\circ\text{C}$)	230V	kW	21	
	400V	kW	36	
	500V	kW	45	
	690V	kW	62	
IEC max current I_e in DC1 with $L/R \leq 1\text{ms}$ with 1 poles in series	$\leq 24\text{V}$	A	35	
	48V	A	30	
	75V	A	23	
	110V	A	8	
	220V	A	-	
	IEC max current I_e in DC1 with $L/R \leq 1\text{ms}$ with 2 poles in series	$\leq 24\text{V}$	A	36
48V		A	34	
75V		A	29	
110V		A	32	
220V		A	4	
IEC max current I_e in DC1 with $L/R \leq 1\text{ms}$ with 3 poles in series		$\leq 24\text{V}$	A	36

	48V	A	34
	75V	A	33
	110V	A	34
	220V	A	30
<hr/>			
IEC max current Ie in DC1 with L/R ≤ 1ms with 4 poles in series			
	≤24V	A	36
	48V	A	34
	75V	A	33
	110V	A	34
	220V	A	38
<hr/>			
IEC max current Ie in DC3-DC5 with L/R ≤ 15ms with 1 poles in series			
	≤24V	A	24
	48V	A	20
	75V	A	17
	110V	A	2,5
	220V	A	–
<hr/>			
IEC max current Ie in DC3-DC5 with L/R ≤ 15ms with 2 poles in series			
	≤24V	A	28
	48V	A	25
	75V	A	22
	110V	A	18
	220V	A	3
<hr/>			
IEC max current Ie in DC3-DC5 with L/R ≤ 15ms with 3 poles in series			
	≤24V	A	32
	48V	A	28
	75V	A	28
	110V	A	23
	220V	A	25
<hr/>			
IEC max current Ie in DC3-DC5 with L/R ≤ 15ms with 4 poles in series			
	≤24V	A	32
	48V	A	28
	75V	A	28
	110V	A	23
	220V	A	15
<hr/>			
Short-time allowable current for 10s (IEC/EN60947-1)		A	320
<hr/>			
Protection fuse			
	gG (IEC)	A	63
	aM (IEC)	A	40
<hr/>			
Making capacity (RMS value)		A	380
<hr/>			
Breaking capacity at voltage			
	440V	A	304
	500V	A	240
	690V	A	192
<hr/>			
Resistance per pole (average value)		mΩ	2
<hr/>			
Power dissipation per pole (average value)			
	Ith	W	6
	AC-3	W	2.9
<hr/>			
Tightening torque for terminals			
	min	Nm	2.5
	max	Nm	3
	min	Ibin	1.8
	max	Ibin	2.2
<hr/>			
Tightening torque for coil terminal			

	min	Nm	0.8
	max	Nm	1
	min	Ibin	0.8
	max	Ibin	0.74
Max number of wires simultaneously connectable		Nr.	2
Conductor section	AWG/Kcmil		
	max		6
Flexible w/o lug conductor section	min	mm ²	2.5
	max	mm ²	16
Flexible c/w lug conductor section	min	mm ²	1
	max	mm ²	10
Flexible with insulated spade lug conductor section	min	mm ²	1
	max	mm ²	10
Power terminal protection according to IEC/EN 60529	IP20 when properly wired		
Mechanical features			
Operating position	normal allowable	Vertical plan ±30°	
Fixing	Screw / DIN rail 35mm		
Weight		g	560
Conductor section	AWG/kcmil conductor section		
	max		6
Operations			
Mechanical life		cycles	20000000
Electrical life		cycles	1400000
Safety related data			
Performance level B10d according to EN/ISO 13489-1	rated load mechanical load	cycles	1400000
		cycles	20000000
Mirror contacts according to IEC/EN 60947-4-1	yes		
EMC compatibility	yes		
DC coil operating			
DC rated control voltage		V	60
DC operating voltage	pick-up		
	min	%Us	70
	max	%Us	125
	drop-out		
	min	%Us	10
	max	%Us	40
Average coil consumption ≤20°C	in-rush holding	W	5.4
		W	5.4
Max cycles frequency			
Mechanical operation		cycles/h	3600
Operating times			

Average time for Us control
in AC

Closing NO	min	ms	8
	max	ms	24
Opening NO	min	ms	5
	max	ms	15
Closing NC	min	ms	9
	max	ms	20
Opening NC	min	ms	9
	max	ms	17

in DC

Closing NO	min	ms	54
	max	ms	66
Opening NO	min	ms	14
	max	ms	17

UL technical data

Full-load current (FLA) for three-phase AC motor

at 480V	A	40
at 600V	A	32

Yielded mechanical performance

for single-phase AC motor

110/120V	HP	3
230V	HP	7.5

for three-phase AC motor

200/208V	HP	10
220/230V	HP	15
460/480V	HP	30
575/600V	HP	30

General USE

Contactor

AC current	A	55
------------	---	----

Short-circuit protection fuse, 600V

High fault

Short circuit current	kA	100
Fuse rating	A	100
Fuse class		J

Standard fault

Short circuit current	kA	5
Fuse rating	A	150

Ambient conditions

Temperature

Operating temperature

min	°C	-50
max	°C	70

Storage temperature

min	°C	-60
max	°C	80

Max altitude

m	3000
---	------

Resistance & Protection

Pollution degree

3

Dimensions

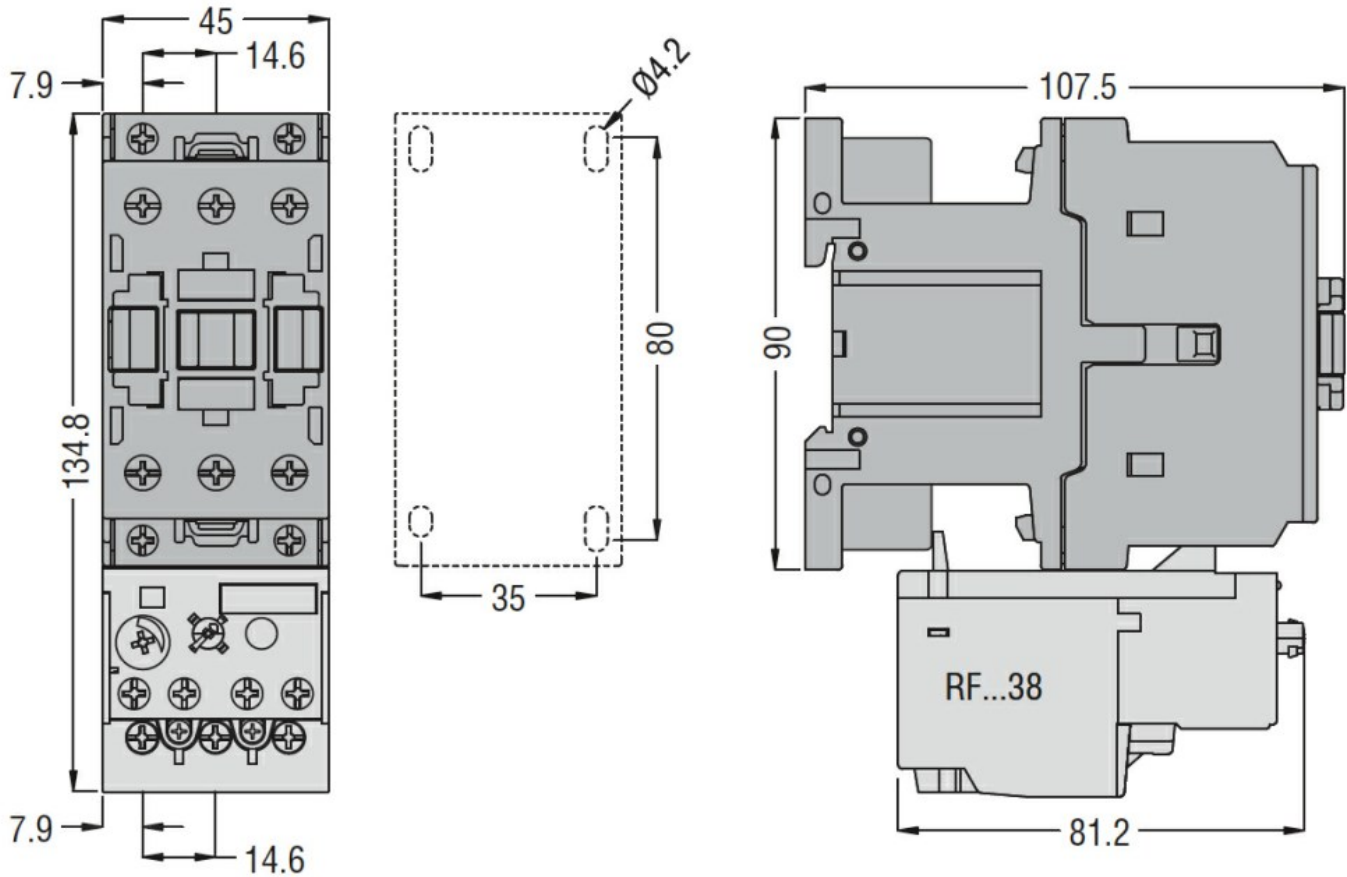

Wiring diagrams

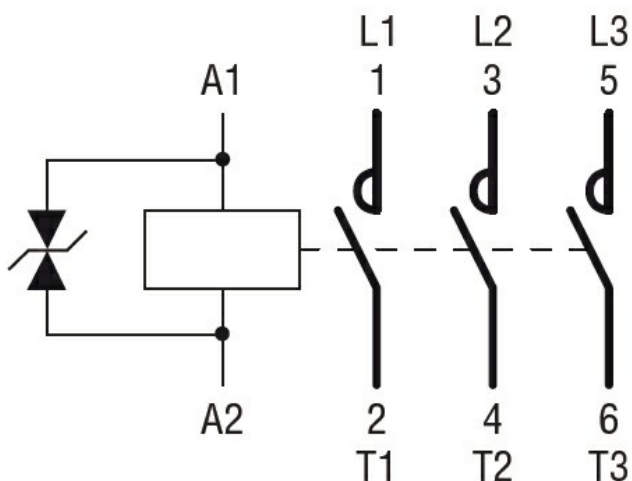

Certifications and compliance

Compliance

CSA C22.2 n° 60947-1

CSA C22.2 n° 60947-4-1

IEC/EN/BS 60947-1

IEC/EN/BS 60947-4-1

UL 60947-1

UL 60947-4-1

Certificates

CCC

cULus

EAC

ETIM classification

ETIM 8.0

EC000066 -
Power contactor,
AC switching