



IP66



IK10



960°



Résistant

Zéro



RoHS



Halogène



UV

Une gamme complète de coffrets polyester et d'équipements pour réaliser simplement et rapidement tout type d'installation en intérieur et en extérieur pour la distribution d'énergie, la distribution de fluides, les automatismes ou les commandes et contrôles dans des environnements extrêmes (intempéries, pollution, milieu acide, milieu marin,...)

DESCRIPTIF TECHNIQUE

Matière première	<ul style="list-style-type: none"> ▪ Polyester chargé de fibres de verre ▪ Sans halogène et sans plomb
Couleur	Gris RAL 7035
UV	Excellente tenue aux UV
Tenue au température	De -50°C à +150°C
Fermeture	<ul style="list-style-type: none"> ▪ 2 points de fermeture (serrure à clé en option) ▪ Serrure de sécurité triangulaire
Porte	<ul style="list-style-type: none"> ▪ Ouverture > à 180° (axe en inox) ▪ Réversible ▪ Livrée filmée
Monobloc	<ul style="list-style-type: none"> ▪ Aucune pièce rapportée ▪ Auvents haut et bas intégrés
Configurations	<ul style="list-style-type: none"> ▪ Nombre équipement max (KIT MOD, PP et/ou GUIDA) : 3 ▪ Capacité en modules : 12 à 36

EQUIPEMENTS

Platine perforée quick	Platine perforée	Platine pleine	Support réglable platine	Kit modulaire	Montant	Guide DIN	Plastron plein	Contreporte	Pattes de fixation standard	Pattes de fixation inox
PF PERFO QUICK	PF PERFO	PF VTR	SCOR PF	KIT MOD	MONT	GUIDA	PP	CP	ST VTR	ST VTR INOX
04772	04782	04765	04682	04790	04651	04660	04795	04760	04680	04688

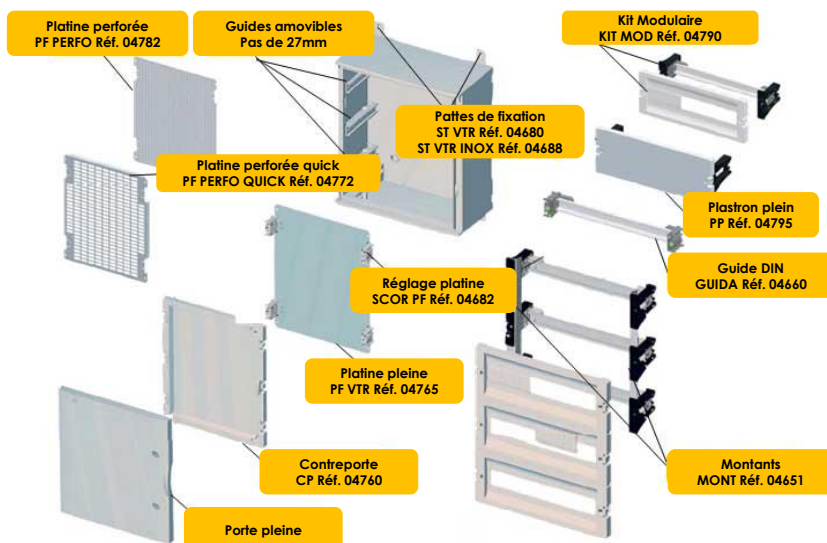
SERRURES

SR VTR

SR VTR 405	04740
SR VTR 421	04741
SR VTR 455	04742
SR VTR 1242E	04743
SR VTR 2433A	04744
SR VTR 3113A	04745

*Toutes les serrures s'adaptent à toutes les références de coffret

NORMES

Certifiée EN 62208

Autres normes de référence :

 IEC 60670-24
IEC 60695-2-11

Expert en cheminement de l'énergie

Service Marketing

Tél.: 01.60.91.72.49

Mail : marketing@iboco.fr

PEDRO

Coffrets polyester
étanches IP66



IP66



IK10



960°



Résistant

Zéro

Halogène



RoHS



SCHEMAS ET COTES (mm)

Dimensions

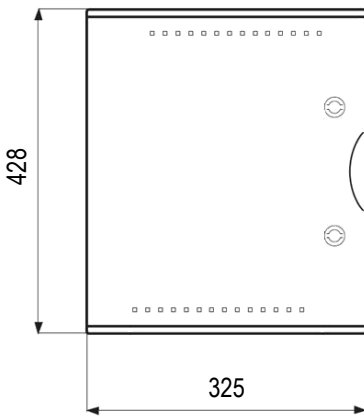

Profondeur

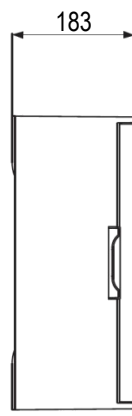

Entraxes de fixation

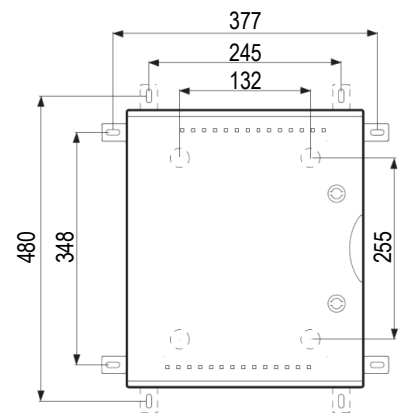

Platine perforée quick — PF PERFO QUICK

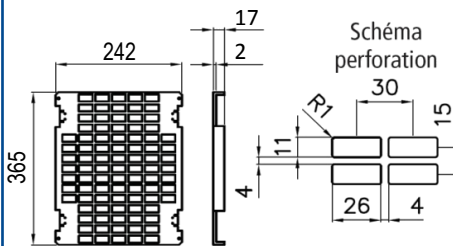

Platine perforée - PERFO

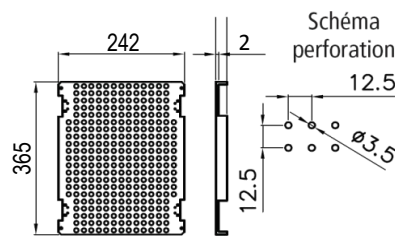

Platine pleine — PF VTR

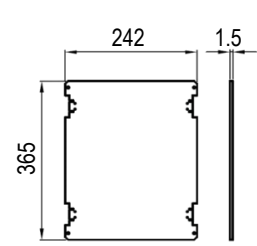

Contreporte- CP

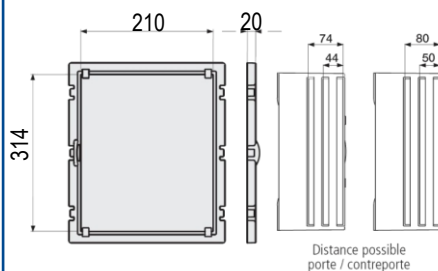

Kit modulaire — KIT MOD

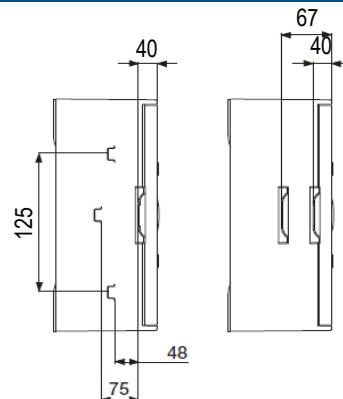

Pattes de fixation ST VTR/ ST VTR INOX

