



DME5000-211S08

DME5000

LONG RANGE DISTANCE SENSORS

SICK
Sensor Intelligence.



Ordering information

| Type | Part no. |
|----------------|----------|
| DME5000-211S08 | 1047031 |

Other models and accessories → www.sick.com/DME5000



Detailed technical data

Mechanics/electronics

| | |
|--|--------------------------------|
| Supply voltage V_S | DC 18 V ... 30 V, limit values |
| Ripple | $< 5 V_{pp}^{1)}$ |
| Initialization time | 1.5 s ²⁾ |
| Housing material | Metal (zinc diecast) |
| Window material | Glass |
| Connection type | Male connector, M16, 8-pin |
| Indication | Display |
| Weight | Approx. 1,650 g |
| Current consumption | At 24 V DC < 250 mA |
| Dimensions (W x H x D) | 61 mm x 101 mm x 176 mm |
| Enclosure rating | IP65 |
| Protection class | II ³⁾ |

¹⁾ May not fall short of or exceed V_S tolerances.

²⁾ After loss of reflector < 1 s at max. speed $V_{max} < 1$ m/s.

³⁾ Reference voltage DC 32 V.

Performance

| | |
|---------------------------------------|--|
| Measurement range min ... max: | 0.15 m ... 150 m, on "diamond grade" reflective tape ¹⁾ |
| Target | Reflector |
| Resolution | 0.05 mm ... 5 mm |
| Repeatability | 1 mm ^{1) 2)} |
| Accuracy | ± 3 mm |
| Response time | 6 ms |
| Output time | 0.2 ms |
| Light source | Laser, red ³⁾ visible red light |

¹⁾ On "diamond grade" reflective tape.

²⁾ Statistical error 1σ , environmental conditions constant, min. warm-up time 10 min.

³⁾ Average service life of 50,000 h at $T_A = +25$ °C.

| | |
|--|--|
| Laser class | 2, complies with 21 CFR 1040.10 and 1040.11 except for the conformance according to "Laser Notice No. 50" from June 24, 2007 (IEC 60825-1:2014, EN 60825-1:2014) |
| Typ. light spot size (distance) | 130 mm (at 70 m) 270 mm (at 150 m) 360 mm (at 220 m) |
| Note | With interpolation of measurement data for high output rate |
| Max. movement speed | 10 m/s |

¹⁾ On "diamond grade" reflective tape.

²⁾ Statistical error 1 σ , environmental conditions constant, min. warm-up time 10 min.

³⁾ Average service life of 50,000 h at $T_A = +25 \text{ }^\circ\text{C}$.

Interfaces

| | |
|-----------------------------------|--|
| SSI | ✓ |
| Digital output | |
| Number | 2 |
| Type | Push-pull: PNP/NPN |
| Maximum output current I_A | $\leq 100 \text{ mA}$ ^{1) 2)} |
| Multifunctional input (MF) | 1 x MF ^{3) 4)} |

¹⁾ Max. 100 nF/20 mH.

²⁾ HIGH = $> V_S - 3 \text{ V}$ / LOW = $< 2 \text{ V}$.

³⁾ HIGH = $> 12 \text{ V}$ / LOW = $< 3 \text{ V}$.

⁴⁾ Not reverse-polarity protected.

Ambient data

| | |
|--|--|
| Electromagnetic compatibility (EMC) | EN 61000-6-2, EN 55011 |
| Ambient temperature, operation | -10 $^\circ\text{C}$... +55 $^\circ\text{C}$ -10 $^\circ\text{C}$... +75 $^\circ\text{C}$, operation with cooling case |
| Ambient temperature, storage | -25 $^\circ\text{C}$... +75 $^\circ\text{C}$ |
| Effect of air pressure | 0.3 ppm/hPa |
| Effect of air temperature | 1 ppm/K |
| Temperature drift | Typ. 0.1 mm/K |
| Typ. Ambient light immunity | $\leq 40,000 \text{ lx}$ |
| Mechanical load | Shock: (EN 600 68-2-27 / -2-29) Sine: (EN 600 68-2-6) Noise: (EN 600 68-2-64) |

Classifications

| | |
|---------------------|----------|
| ECLASS 5.0 | 27270801 |
| ECLASS 5.1.4 | 27270801 |
| ECLASS 6.0 | 27270801 |
| ECLASS 6.2 | 27270801 |
| ECLASS 7.0 | 27270801 |
| ECLASS 8.0 | 27270801 |
| ECLASS 8.1 | 27270801 |
| ECLASS 9.0 | 27270801 |
| ECLASS 10.0 | 27270801 |
| ECLASS 11.0 | 27270801 |

| | |
|-----------------------|----------|
| ECLASS 12.0 | 27270916 |
| ETIM 5.0 | EC001825 |
| ETIM 6.0 | EC001825 |
| ETIM 7.0 | EC001825 |
| ETIM 8.0 | EC001825 |
| UNSPSC 16.0901 | 41111613 |

Dimensional drawing (Dimensions in mm (inch))

DME5000 SSI

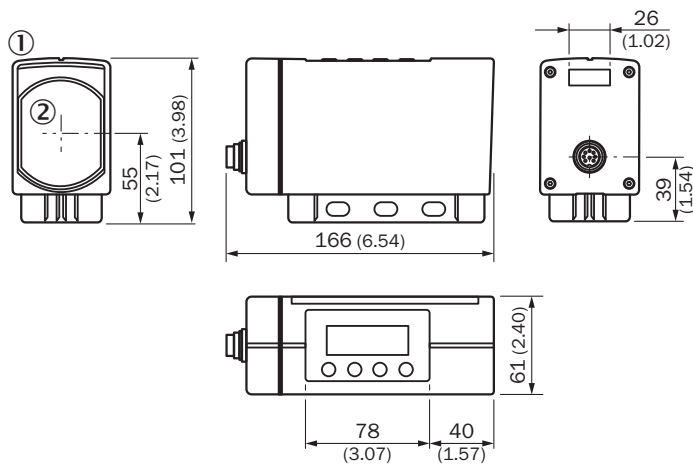

- ① LC display
- ② Center of optical axis

Working range diagram

DL1000 measuring range based on measurement cycle time and reflector type

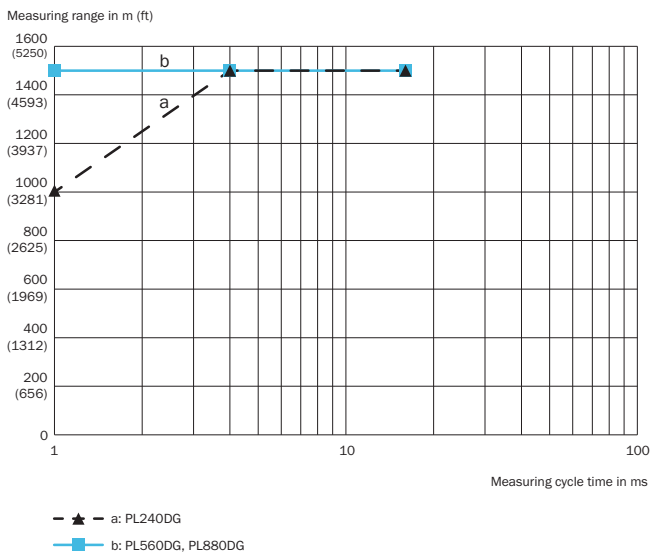

Connection type

DME4/5xxx SSI/RS-422 Connector M16, 8-pin



Connection diagram

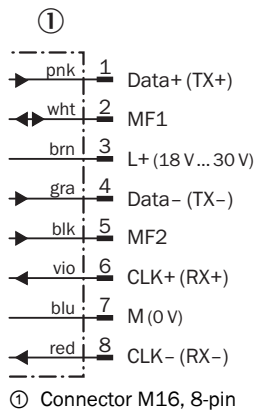

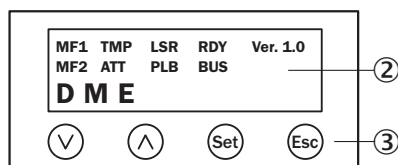

Adjustment possible







- ② LC display
- ③ Keypad

Recommended accessories

Other models and accessories → www.sick.com/DME5000

| | Brief description | Type | Part no. |
|---|---|--------------------|----------|
| Plug connectors and cables | | | |
|  | <ul style="list-style-type: none"> • Connection type head A: Female connector, M12, 5-pin, straight, B-coded • Connection type head B: Flying leads • Signal type: PROFIBUS DP • Cable: 5 m, 2-wire, PUR, halogen-free • Description: PROFIBUS DP, twisted pair, shielded, Head A: female connector, M12, 5-pin, straight Head B: cable Cable: suitable for drag chain, PUR, halogen-free, shielded, 2 x 0.34 mm², Ø 8.0 mm • Connection systems: Flying leads • Application: Zones with oils and lubricants | DOL-1205-G05MQ | 6026006 |
|  | <ul style="list-style-type: none"> • Connection type head A: Female connector, M12, 5-pin, A-coded • Connection type head B: Flying leads • Signal type: Power, CAN • Cable: 5 m, 5-wire • Description: Power, unshielded CAN | DOL-1205-G05M_Can | 6021166 |
|  | <ul style="list-style-type: none"> • Connection type head A: Female connector, M12, 5-pin, straight • Connection type head B: Flying leads • Signal type: CANopen • Cable: 6 m • Description: CANopen, shielded | DOL-1205-G06MK | 6028326 |
|  | <ul style="list-style-type: none"> • Connection type head A: Female connector, M12, 5-pin, straight, B-coded • Connection type head B: Flying leads • Signal type: PROFIBUS DP • Cable: 10 m, 2-wire, PUR, halogen-free • Description: PROFIBUS DP, twisted pair, shielded • Connection systems: Flying leads • Application: Zones with oils and lubricants | DOL-1205-G10MQ | 6026008 |
| | <ul style="list-style-type: none"> • Connection type head A: Female connector, M12, 5-pin, straight, B-coded • Connection type head B: Flying leads • Signal type: PROFIBUS DP • Cable: 15 m, 2-wire, PUR, halogen-free • Description: PROFIBUS DP, twisted pair, shielded • Connection systems: Flying leads • Application: Zones with oils and lubricants | DOL-1205-G15MQ | 6032637 |
|  | <p>Head A: male connector, M12, 5-pin, straight, B-coded</p> <ul style="list-style-type: none"> • Connection type head A: Male connector, M12, 5-pin, straight, B-coded • Connection type head B: Flying leads • Signal type: PROFIBUS DP • Cable: 10 m, 2-wire, PUR, halogen-free • Description: PROFIBUS DP, twisted pair, shielded • Note: Wire shield Al-Pt film, overall shield C-screen tin-plated • Application: Zones with oils and lubricants, Drag chain operation | STL-1205-G05MQ | 6026005 |
| | <p>Head A: male connector, M12, 5-pin, straight, B-coded</p> <ul style="list-style-type: none"> • Connection type head A: Male connector, M12, 5-pin, straight, B-coded • Connection type head B: Flying leads • Signal type: PROFIBUS DP • Cable: 10 m, 2-wire, PUR, halogen-free • Description: PROFIBUS DP, twisted pair, shielded • Note: Wire shield Al-Pt film, overall shield C-screen tin-plated • Application: Zones with oils and lubricants, Drag chain operation | STL-1205-G10MQ | 6026007 |
|  | <p>Head A: male connector, M12, 5-pin, straight, B-coded</p> <ul style="list-style-type: none"> • Connection type head A: Female connector, M12, 5-pin, straight • Connection type head B: Flying leads • Signal type: CANopen • Cable: 10 m, 5-wire • Description: CANopen, shielded • Connection systems: Flying leads • Note: Shielded on pin 1 | STL-1205-G15MQ | 6036898 |
|  | <p>Head A: female connector, M12, 8-pin, straight</p> | YF2A14-100C1BXLEAX | 6021175 |
| | | YF2A68-020XXXLEAX | 6032448 |
| | | YF2A68-050XXXLEAX | 6032449 |
| | | YF2A68-100XXXLEAX | 6032450 |

| | Brief description | Type | Part no. |
|---|---|--------------------|----------|
|  | Head A: female connector, M16, 8-pin, straight | YF2Z18-050XXXXLEBX | 2026742 |
|  | <ul style="list-style-type: none"> • Connection type head A: Female connector, 7/8", 5-pin, straight • Signal type: DeviceNet™, CANopen • Description: DeviceNet™, terminal resistor, shielded CANopen • Permitted cross-section: ≤ 1.5 mm² • Note: For field bus technology | DOS-7805-GKEND | 6028329 |
|  | <ul style="list-style-type: none"> • Connection type head A: Male connector, M12, 4-pin, straight, B-coded • Signal type: PROFIBUS DP • Description: PROFIBUS DP, terminal resistor | STE-END-Q | 6021156 |
| Reflectors | | | |
|  | Reflector plate, "diamond grade" reflective tape, 665 mm x 665 mm, base plate material: aluminum, screw connection, Screw-on, 4 hole mounting | PL560DG | 1016806 |
| Terminal and alignment brackets | | | |
|  | Alignment unit for DME5000, stainless steel (1.4541), incl. mounting material, additional base plate mounting kit required, mounting hardware included | BEF-AH-DME | 2027721 |

SICK AT A GLANCE

SICK is one of the leading manufacturers of intelligent sensors and sensor solutions for industrial applications. A unique range of products and services creates the perfect basis for controlling processes securely and efficiently, protecting individuals from accidents and preventing damage to the environment.

We have extensive experience in a wide range of industries and understand their processes and requirements. With intelligent sensors, we can deliver exactly what our customers need. In application centers in Europe, Asia and North America, system solutions are tested and optimized in accordance with customer specifications. All this makes us a reliable supplier and development partner.

Comprehensive services complete our offering: SICK LifeTime Services provide support throughout the machine life cycle and ensure safety and productivity.

For us, that is “Sensor Intelligence.”

WORLDWIDE PRESENCE:

Contacts and other locations –www.sick.com