



KTM-MP317A1P

KTM

CONTRAST SENSORS

SICK
Sensor Intelligence.



Illustration may differ

Ordering information

| Type | Part no. |
|--------------|----------|
| KTM-MP317A1P | 1071482 |

Other models and accessories → www.sick.com/KTM



Detailed technical data

Features

| | |
|-----------------------------------|---|
| Dimensions (W x H x D) | 12 mm x 31.5 mm x 21 mm |
| Sensing distance | ≤ 12.5 mm |
| Sensing distance tolerance | ± 3 mm |
| Housing design | Small |
| Light source | LED, white ¹⁾ |
| Light emission | Long side of housing |
| Light spot size | Ø 2 mm (12.5 mm) |
| Light spot direction | Round |
| Receiving filters | None |
| Adjustment | Cable, IO-Link, Teach-in button |
| Teach-in mode | 2-point teach-in static/dynamic + proximity to mark |

¹⁾ Average service life: 100,000 h at T_U = +25 °C.

Mechanics/electronics

| | |
|-----------------------|-----------------------------------|
| Supply voltage | 12 V DC ... 24 V DC ¹⁾ |
| Ripple | ≤ 5 V _{pp} ²⁾ |

¹⁾ Limit values: DC 12 V (-10 %) ... DC 24 V (+20 %). Operation in short-circuit protected network max. 8 A.

²⁾ May not exceed or fall below U_v tolerances.

³⁾ Without load.

⁴⁾ With light/dark ratio 1:1.

⁵⁾ Signal transit time with resistive load.

⁶⁾ Total current of all Outputs.

| | |
|---|---|
| Current consumption | < 50 mA ³⁾ |
| Switching frequency | 15 kHz ⁴⁾ |
| Response time | 32 µs ⁵⁾ |
| Jitter | 15 µs |
| Switching output | PNP |
| Switching output (voltage) | PNP: HIGH = $U_V \leq 2 \text{ V}$ / LOW approx. 0 V |
| Switching mode | Light/dark switching |
| Output current I_{max} | 50 mA ⁶⁾ |
| Retention time (ET) | 28 ms, non-volatile memory |
| Time delay | Switch-off delay, 520 ms (via IO-Link) |
| Connection type | Male connector M8, 4-pin |
| Protection class | III |
| Circuit protection | U_V connections, reverse polarity protected Output Q short-circuit protected Interference pulse suppression |
| Enclosure rating | IP67 |
| Weight | 20 g |
| Housing material | Plastic, ABS |
| Optics material | Plastic, PMMA |
| Indication | LED indicator green: power on LED indicator, yellow: Status switching output Q |

¹⁾ Limit values: DC 12 V (-10 %) ... DC 24 V (+20 %). Operation in short-circuit protected network max. 8 A.

²⁾ May not exceed or fall below U_V tolerances.

³⁾ Without load.

⁴⁾ With light/dark ratio 1:1.

⁵⁾ Signal transit time with resistive load.

⁶⁾ Total current of all Outputs.

Communication interface

| | |
|---------------------------------|---|
| IO-Link | ✓, V1.1 |
| Data transmission rate | 38,4 kbit/s (COM2) |
| Cycle time | 2.3 ms |
| Process data length | 16 Bit |
| Process data structure A | Bit 0 = switching signal Q_{L1} Bit 1 ... 10 = Measurement Value Emission Color Bit 11 ... 15 = empty |
| Process data structure B | Bit 0 = switching signal Q_{L1} Bit 1 = Quality of Run Alarm Bit 2 = Teach successful Bit 3 = Teach busy Bit 4 ... 15 = empty |
| Digital output | Q_1, Q_2 |
| Number | 2 |

Ambient data

| | |
|--------------------------------------|-------------------|
| Ambient operating temperature | -10 °C ... +55 °C |
| Ambient temperature, storage | -20 °C ... +75 °C |

| | |
|--------------------|------------------------------|
| Shock load | According to IEC 60068 |
| UL File No. | NRKH.E348498 & NRKH7.E348498 |

Classifications

| | |
|-----------------------|----------|
| ECLASS 5.0 | 27270906 |
| ECLASS 5.1.4 | 27270906 |
| ECLASS 6.0 | 27270906 |
| ECLASS 6.2 | 27270906 |
| ECLASS 7.0 | 27270906 |
| ECLASS 8.0 | 27270906 |
| ECLASS 8.1 | 27270906 |
| ECLASS 9.0 | 27270906 |
| ECLASS 10.0 | 27270906 |
| ECLASS 11.0 | 27270906 |
| ECLASS 12.0 | 27270906 |
| ETIM 5.0 | EC001820 |
| ETIM 6.0 | EC001820 |
| ETIM 7.0 | EC001820 |
| ETIM 8.0 | EC001820 |
| UNSPSC 16.0901 | 39121528 |

Connection/Pin assignment

| | | | | | | | | | |
|------------------------|--|------|--------|------|---|------|-------|------|-----|
| Connection type | Male connector M8, 4-pin | | | | | | | | |
| Pin assignment | <table border="0"> <tr><td>BN 1</td><td>+ (L+)</td></tr> <tr><td>WH 2</td><td>Q</td></tr> <tr><td>BU 3</td><td>- (M)</td></tr> <tr><td>BK 4</td><td>Q/C</td></tr> </table> | BN 1 | + (L+) | WH 2 | Q | BU 3 | - (M) | BK 4 | Q/C |
| BN 1 | + (L+) | | | | | | | | |
| WH 2 | Q | | | | | | | | |
| BU 3 | - (M) | | | | | | | | |
| BK 4 | Q/C | | | | | | | | |

Dimensional drawing (Dimensions in mm (inch))

KTM-Mxxxxx1P, KTM-Wxxxxx1P

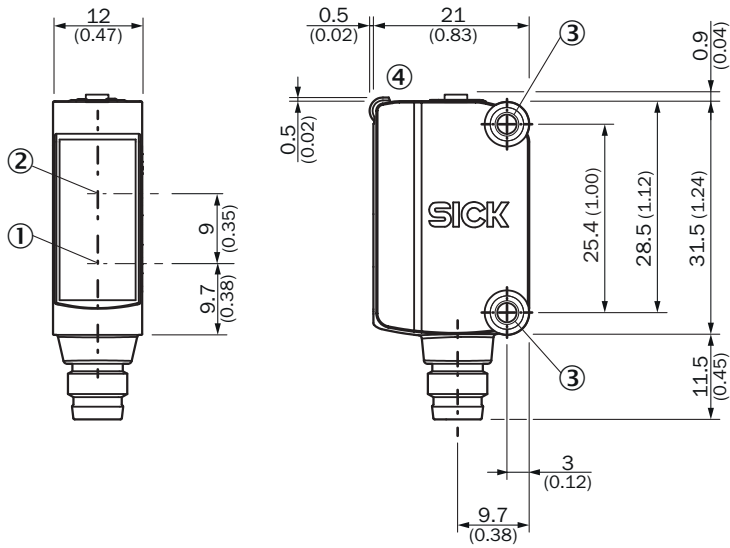

- ① Center of optical axis, sender
- ② Center of optical axis, receiver
- ③ Mounting holes M3
- ④ Display and adjustment elements

Adjustments

Display and adjustment elements

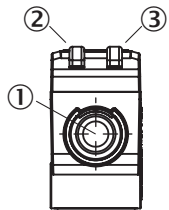

- ① Teach-in button
- ② LED yellow
- ③ LED green

Pin assignment

Connection type. see table: Connection/PIN assignment

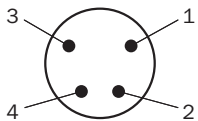

Male connector, M8, 4-pin, uncoded

Concept of operation

Setting the switching threshold (dynamic)

1. Position background

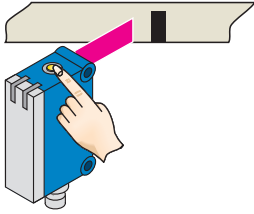

Press the teach-in button and keep it pressed. LED flashing slowly.

2. Move at least the mark and background using the light spot.

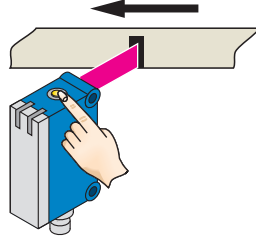

Keep the teach-in button > 3 < 30 s pressed.

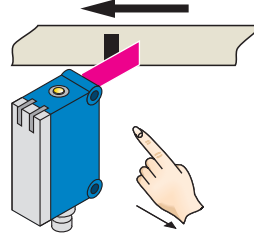

Release the teach-in button.

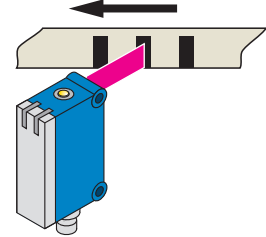

Yellow LED will illuminate, when emitted light is on the mark.

Example

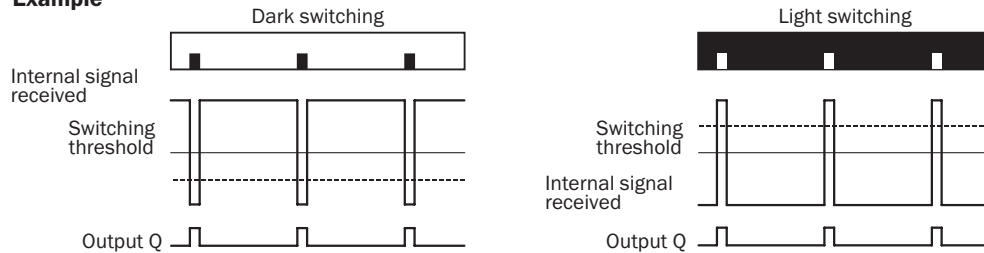

Switching characteristics

The optimum emitted light is selected automatically (at RGB variants).

Static teach-in: light/dark setting is defined using teach-in sequence.

Dynamic teach-in: switching output active on mark, if background is longer in the field of view during the teach-in.

The switching threshold is set in the center between the background and the mark.

If the button is pressed again within 10 s of the teach (> 20 ms < 10 s), the relative switching threshold is placed 75 % between mark (100 %) and background (0 %) (dotted line in Figure).

Teach-in can also be performed using an external control signal.

Keylock activation and deactivation: hold down teach-in button > 30 s.

Teach-in failure: yellow LED indicator and the transmitted light of the sensor flashing quickly.

For dynamic teach-in with ET signal (5 Hz) via switching output Q.

Setting the switching threshold (static)

1. Position mark

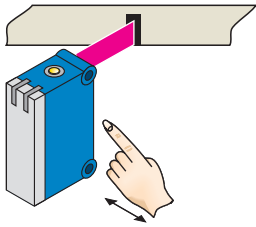

Press and hold teach-in button > 1 < 3 s.
Yellow LED flashes slowly.

2. Position background

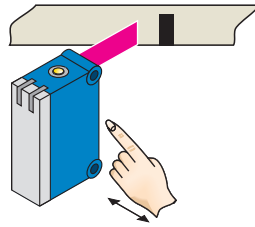

Press and hold teach-in button < 3 s.
Yellow LED goes out.

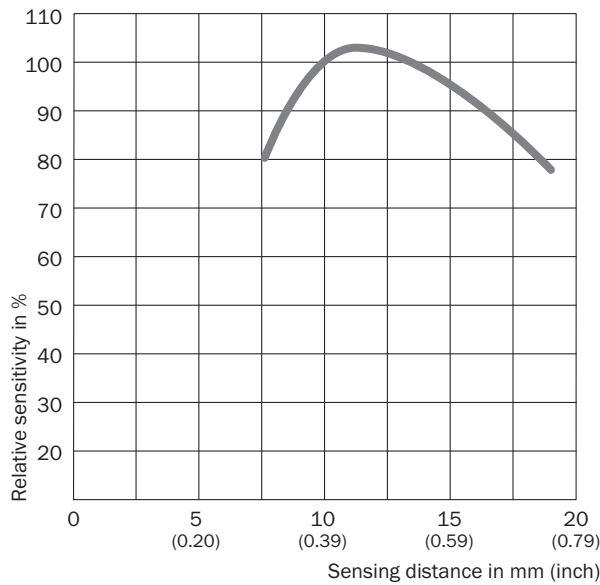

Sensing distance



Recommended accessories

Other models and accessories → www.sick.com/KTM

| | Brief description | Type | Part no. |
|---|---|------------|----------|
| Mounting brackets and plates | | | |
|  | Mounting bracket for wall mounting, stainless steel, mounting hardware included | BEF-W100-A | 5311520 |

| | Brief description | Type | Part no. |
|---|---|--------------------|----------|
| Plug connectors and cables | | | |
|  | <ul style="list-style-type: none"> • Connection type head A: Female connector, M8, 4-pin, straight, A-coded • Connection type head B: Flying leads • Signal type: Sensor/actuator cable • Cable: 5 m, 4-wire, PVC • Description: Sensor/actuator cable, unshielded • Application: Zones with chemicals | YF8U14-050VA3XLEAX | 2095889 |
|  | <ul style="list-style-type: none"> • Connection type head A: Female connector, M8, 4-pin, straight, A-coded • Connection type head B: Male connector, M12, 4-pin, straight, A-coded • Signal type: Sensor/actuator cable • Cable: 5 m, 4-wire, PVC • Description: Sensor/actuator cable, unshielded • Application: Zones with chemicals | YF8U14-050VA3M2A14 | 2096609 |

SICK AT A GLANCE

SICK is one of the leading manufacturers of intelligent sensors and sensor solutions for industrial applications. A unique range of products and services creates the perfect basis for controlling processes securely and efficiently, protecting individuals from accidents and preventing damage to the environment.

We have extensive experience in a wide range of industries and understand their processes and requirements. With intelligent sensors, we can deliver exactly what our customers need. In application centers in Europe, Asia and North America, system solutions are tested and optimized in accordance with customer specifications. All this makes us a reliable supplier and development partner.

Comprehensive services complete our offering: SICK LifeTime Services provide support throughout the machine life cycle and ensure safety and productivity.

For us, that is “Sensor Intelligence.”

WORLDWIDE PRESENCE:

Contacts and other locations –www.sick.com