



LUT1U-31231

LUT1

LUMINESCENCE SENSORS

SICK
Sensor Intelligence.



Illustration may differ



Ordering information

Type	Part no.
LUT1U-31231	1028075

Other models and accessories → www.sick.com/LUT1

Detailed technical data

Features

Dimensions (W x H x D)	23 mm x 70 mm x 60 mm
Sensing distance	≤ 150 mm ¹⁾
Housing design	Middle
Working range	60 mm ... 160 mm
Light source	LED, UV ²⁾
Wave length	375 nm
Light emission	Long side
Light spot size	12 mm x 12 mm
Receiving filters	KV 418 (standard)
Receiving range	450 nm ... 750 nm
Adjustment	Double teach-in button
Output function	Light switching

¹⁾ From leading edge of lens.

²⁾ Average service life: 100,000 h at T_U = +25 °C.

Mechanics/electronics

Supply voltage	10 V DC ... 30 V DC ¹⁾
Ripple	< 5 V _{pp} ²⁾
Current consumption	< 40 mA ³⁾
Switching frequency	600 Hz ⁴⁾

¹⁾ Limit values when operated in short-circuit protected network: max. 8 A.

²⁾ May not exceed or fall below U_v tolerances.

³⁾ Without load.

⁴⁾ With light/dark ratio 1:1, without timer stage.

⁵⁾ Signal transit time with resistive load.

⁶⁾ Reference voltage DC 50 V.

Response time	8 ms ⁵⁾
Switching output	PNP, NPN
Switching output (voltage)	PNP: HIGH = $U_V \leq 2 \text{ V}$ / LOW approx. 0 V NPN: HIGH = approx. U_V / LOW $\leq 2 \text{ V}$
Switching mode	Light switching
Output current I_{max}	200 mA
Connection type	Male connector M12, 5-pin
Protection class	III ⁶⁾
Circuit protection	U_V connections, reverse polarity protected Output Q short-circuit protected Interference pulse suppression
Enclosure rating	IP67
Weight	240 g
Housing material	Metal, zinc diecast

1) Limit values when operated in short-circuit protected network: max. 8 A.

2) May not exceed or fall below U_V tolerances.

3) Without load.

4) With light/dark ratio 1:1, without timer stage.

5) Signal transit time with resistive load.

6) Reference voltage DC 50 V.

Ambient data

Ambient operating temperature	-20 °C ... +60 °C
Ambient temperature, storage	-40 °C ... +70 °C
Shock load	According to IEC 60068

Classifications

eCl@ss 5.0	27270908
eCl@ss 5.1.4	27270908
eCl@ss 6.0	27270908
eCl@ss 6.2	27270908
eCl@ss 7.0	27270908
eCl@ss 8.0	27270908
eCl@ss 8.1	27270908
eCl@ss 9.0	27270908
eCl@ss 10.0	27270908
eCl@ss 11.0	27270908
eCl@ss 12.0	27270908
ETIM 5.0	EC001822
ETIM 6.0	EC001822
ETIM 7.0	EC001822
ETIM 8.0	EC001822
UNSPSC 16.0901	39121528

Dimensional drawing (Dimensions in mm (inch))

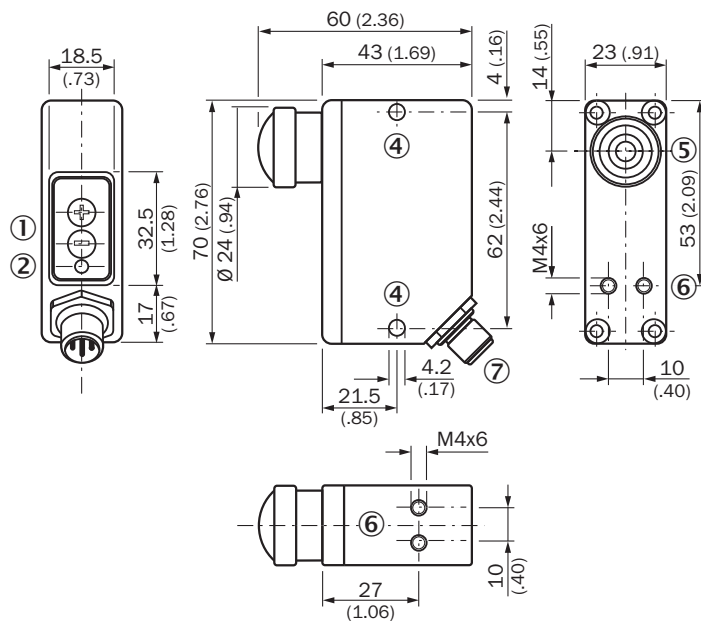

- ① Control elements
- ② LED signal strength indicator
- ④ Fixing hole
- ⑤ Optical axis
- ⑥ Threaded mounting hole
- ⑦ Male connector M12

Adjustments

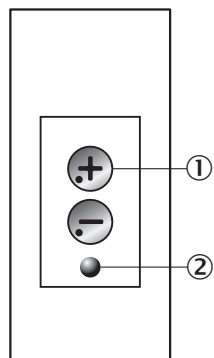

- ① Control elements
- ② LED signal strength indicator

Pin assignment

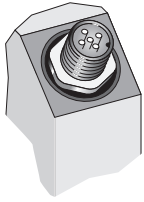

Connection diagram

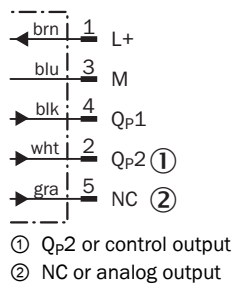

Sensing distance

Sensing distance

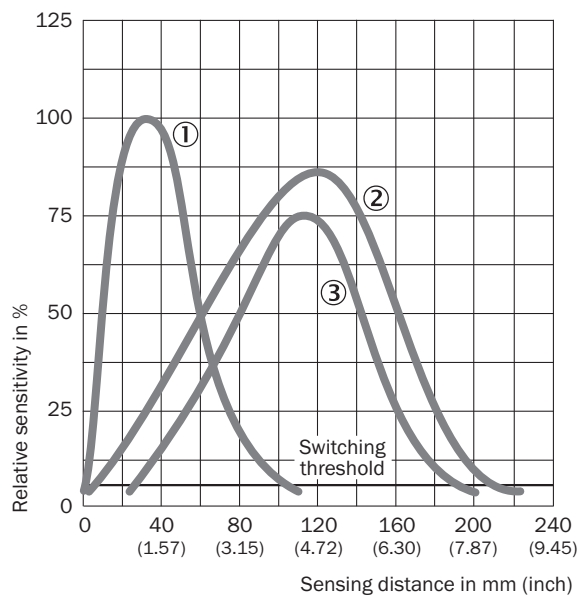

- ① LUT1B sensing distance 50 mm; scan material: acryl orange
- ② LUT1B sensing distance 150 mm; scan material: acryl orange
- ③ LUT1U sensing distance 150 mm; scan material: SICK Luminescence reference 100 %

Light spot size

Light spot size

Sensing distance 50 mm

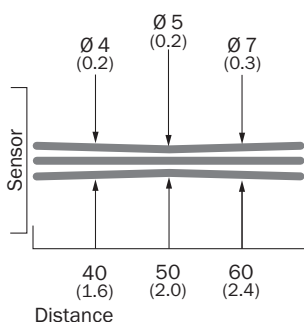

Sensing distance 80 mm

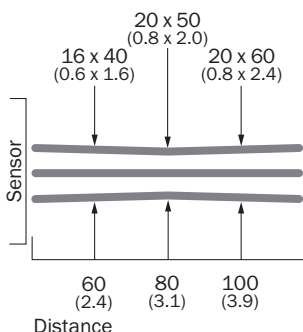

Sensing distance 150 mm

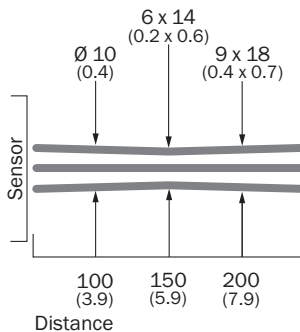



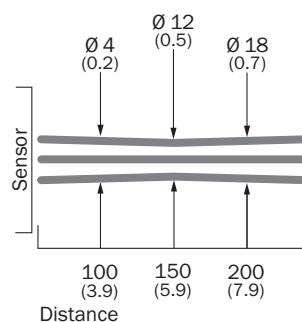



Sensing distance 150 mm





All dimensions in mm (inch)

Recommended accessories

Other models and accessories → www.sick.com/LUT1

	Brief description	Type	Part no.
Reference materials			
	Thick chalk, red fluorescent, 12 units	LUM-FT	1004460
	Writing chalk, red fluorescence	LUM-KLK	1002959
Universal bar clamp systems			
	Universal clamp bracket for rod mounting, steel, zinc coated, without mounting hardware	BEF-KHS-KH1	2022726
	Mounting bar, straight, 200 mm, steel, steel, zinc coated, without mounting hardware	BEF-MS12G-A	4056054
	Mounting bar, straight, 300 mm, steel, steel, zinc coated, without mounting hardware	BEF-MS12G-B	4056055
	Mounting bar, L-shaped, 150 mm x 150 mm, steel, steel, zinc coated, without mounting hardware	BEF-MS12L-A	4056052
	Mounting bar, L-shaped, 250 x 250 mm, steel, steel, zinc coated, without mounting hardware	BEF-MS12L-B	4056053
Plug connectors and cables			
	Head A: female connector, M12, 5-pin, straight, A-coded Head B: Flying leads Cable: Sensor/actuator cable, PVC, unshielded, 2 m	YF2A15-020VB5XLEAX	2096239
	Head A: female connector, M12, 5-pin, straight, A-coded Head B: Flying leads Cable: Sensor/actuator cable, PVC, unshielded, 5 m	YF2A15-050VB5XLEAX	2096240

	Brief description	Type	Part no.
	Head A: female connector, M12, 5-pin, straight, A-coded Head B: Flying leads Cable: Sensor/actuator cable, PVC, unshielded, 10 m	YF2A15-100VB5XLEAX	2096241
	Head A: female connector, M12, 5-pin, angled, A-coded Head B: Flying leads Cable: Sensor/actuator cable, PVC, unshielded, 2 m	YG2A15-020VB5XLEAX	2096215
	Head A: female connector, M12, 5-pin, angled, A-coded Head B: Flying leads Cable: Sensor/actuator cable, PVC, unshielded, 5 m	YG2A15-050VB5XLEAX	2096216
	Head A: female connector, M12, 5-pin, angled, A-coded Head B: Flying leads Cable: Sensor/actuator cable, PVC, unshielded, 10 m	YG2A15-100VB5XLEAX	2096217
	Head A: female connector, M12, 5-pin, straight Cable: unshielded	DOS-1205-G	6009719
	 Head A: female connector, M12, 5-pin, angled Cable: unshielded	DOS-1205-W	6009720

SICK AT A GLANCE

SICK is one of the leading manufacturers of intelligent sensors and sensor solutions for industrial applications. A unique range of products and services creates the perfect basis for controlling processes securely and efficiently, protecting individuals from accidents and preventing damage to the environment.

We have extensive experience in a wide range of industries and understand their processes and requirements. With intelligent sensors, we can deliver exactly what our customers need. In application centers in Europe, Asia and North America, system solutions are tested and optimized in accordance with customer specifications. All this makes us a reliable supplier and development partner.

Comprehensive services complete our offering: SICK LifeTime Services provide support throughout the machine life cycle and ensure safety and productivity.

For us, that is “Sensor Intelligence.”

WORLDWIDE PRESENCE:

Contacts and other locations –www.sick.com