



# VL18L-4N344

V18 Laser

CYLINDRICAL PHOTOELECTRIC SENSORS

**SICK**  
Sensor Intelligence.



Illustration may differ



### Ordering information

Type	Part no.
VL18L-4N344	6027436

Other models and accessories → [www.sick.com/V18\\_Laser](http://www.sick.com/V18_Laser)

### Detailed technical data

#### Features

<b>Functional principle</b>	Photoelectric retro-reflective sensor
<b>Functional principle detail</b>	Dual lens
<b>Dimensions (W x H x D)</b>	18 mm x 18 mm x 107.7 mm
<b>Housing design (light emission)</b>	Cylindrical
<b>Housing length</b>	107.7 mm
<b>Thread diameter (housing)</b>	M18 x 1
<b>Optical axis</b>	Radial
<b>Sensing range max.</b>	0.1 m ... 35 m <sup>1)</sup>
<b>Sensing range</b>	0.1 m ... 30 m <sup>1)</sup>
<b>Focus</b>	0.04°
<b>Type of light</b>	Visible red light
<b>Light source</b>	Laser <sup>2)</sup>
<b>Light spot size (distance)</b>	Ø 9 mm (35 m)
<b>Angle of dispersion</b>	0.04°
<b>Wave length</b>	650 nm
<b>Laser class</b>	1 (IEC 60825-1)
<b>Laser power output</b>	0.4 mW
<b>Adjustment</b>	Cable (Sensitivity) <sup>3)</sup> Single teach-in button (Sensitivity) <sup>4)</sup>
<b>Special applications</b>	Detecting small objects

<sup>1)</sup> Reflector P250F.

<sup>2)</sup> Average service life: 100,000 h at T<sub>J</sub> = +25 °C.

<sup>3)</sup> Electronically via control input C (0 V).

<sup>4)</sup> Manual, via teach-in button.

## Mechanics/electronics

<b>Supply voltage</b>	10 V DC ... 30 V DC <sup>1)</sup>
<b>Ripple</b>	± 10 % <sup>2)</sup>
<b>Current consumption</b>	20 mA <sup>3)</sup>
<b>Switching output</b>	NPN
<b>Switching mode</b>	Light/dark switching
<b>Switching mode selector</b>	Selectable via control input C
<b>Output current I<sub>max.</sub></b>	≤ 100 mA
<b>Response time</b>	≤ 0.625 ms <sup>4)</sup>
<b>Switching frequency</b>	800 Hz <sup>5)</sup>
<b>Connection type</b>	Male connector M12, 4-pin
<b>Circuit protection</b>	A <sup>6)</sup> B <sup>7)</sup> C <sup>8)</sup> D <sup>9)</sup>
<b>Protection class</b>	III
<b>Weight</b>	60 g
<b>Polarisation filter</b>	✓
<b>Housing material</b>	Metal, Nickel-plated brass/PC
<b>Optics material</b>	Plastic, PC with protective glass pane
<b>Enclosure rating</b>	IP67
<b>Ambient operating temperature</b>	-15 °C ... +55 °C
<b>Ambient temperature, storage</b>	-25 °C ... +70 °C
<b>UL File No.</b>	NRKH.E181493, CDRH-conform (0312012-00)

<sup>1)</sup> Limit values.

<sup>2)</sup> May not exceed or fall below U<sub>v</sub> tolerances.

<sup>3)</sup> Without load.

<sup>4)</sup> Signal transit time with resistive load.

<sup>5)</sup> With light/dark ratio 1:1.

<sup>6)</sup> A = V<sub>S</sub> connections reverse-polarity protected.

<sup>7)</sup> B = inputs and output reverse-polarity protected.

<sup>8)</sup> C = interference suppression.

<sup>9)</sup> D = outputs overcurrent and short-circuit protected.

## Classifications

<b>eCl@ss 5.0</b>	27270902
<b>eCl@ss 5.1.4</b>	27270902
<b>eCl@ss 6.0</b>	27270902
<b>eCl@ss 6.2</b>	27270902
<b>eCl@ss 7.0</b>	27270902
<b>eCl@ss 8.0</b>	27270902
<b>eCl@ss 8.1</b>	27270902
<b>eCl@ss 9.0</b>	27270902
<b>eCl@ss 10.0</b>	27270902

<b>eCl@ss 11.0</b>	27270902
<b>eCl@ss 12.0</b>	27270902
<b>ETIM 5.0</b>	EC002717
<b>ETIM 6.0</b>	EC002717
<b>ETIM 7.0</b>	EC002717
<b>ETIM 8.0</b>	EC002717
<b>UNSPSC 16.0901</b>	39121528

### Connection type

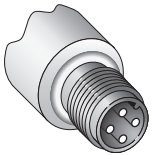

### Connection diagram

Cd-099

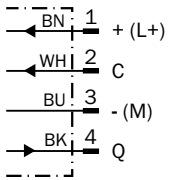

### Characteristic curve

Operating reserve

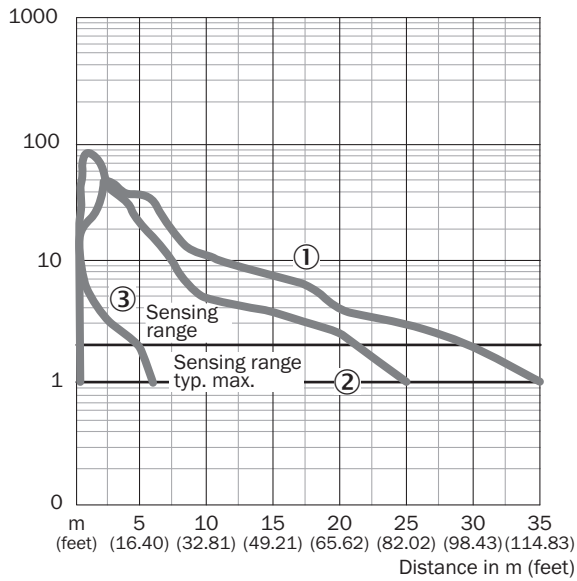

- ① Reflector P250F
- ② Reflector PL80A, P250
- ③ Reflective tape Diamond Grade

### Light spot size

VL18L

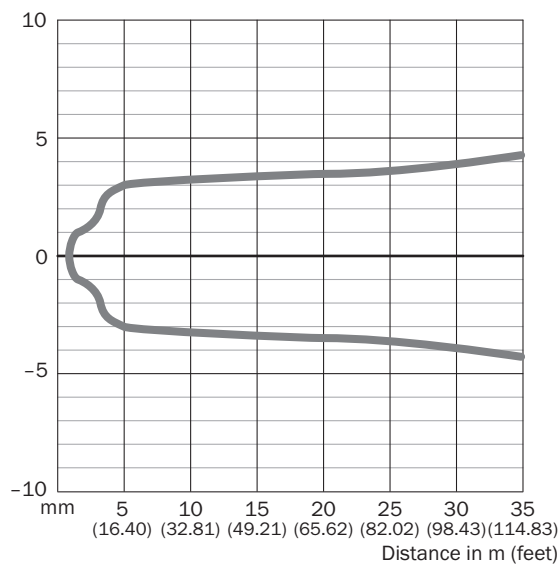

Sensing range diagram

VL18L

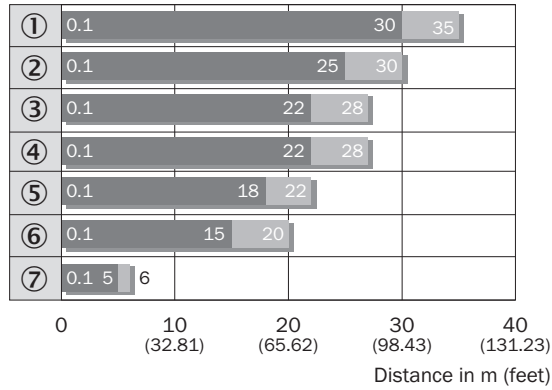

- Sensing range      ■ Sensing range max.
- ① Reflector P250F
- ② PL10F reflector
- ③ Reflector PL80A
- ④ Reflector P250
- ⑤ Reflector C110A
- ⑥ Reflector PL20F
- ⑦ Reflective tape Diamond Grade

Dimensional drawing (Dimensions in mm (inch))

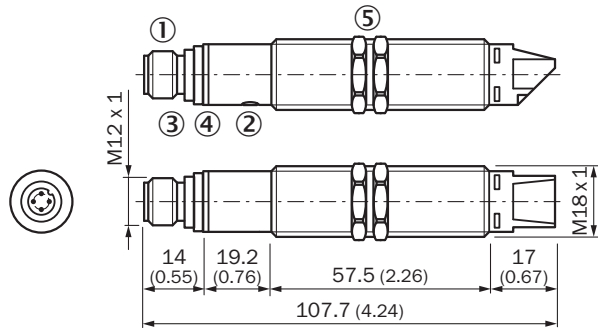

Radial



- ① M12 male device connector, 4-pin
- ② Sensitivity setting: single teach-in button
- ③ Green LED indicator:  $V_S$  Supply voltage feed
- ④ Yellow LED indicator: - lights continuously: Reception signal > reserve factor 2 - blinks: Reception signal < reserve factor 2 but > switching threshold 1
- ⑤ Fastening nuts (2 x); width across 24, metal(included with delivery)

## Recommended accessories

Other models and accessories → [www.sick.com/V18\\_Laser](http://www.sick.com/V18_Laser)

	Brief description	Type	Part no.
<b>Plug connectors and cables</b>			
	Head A: female connector, M12, 4-pin, straight, A-coded Head B: Flying leads Cable: Sensor/actuator cable, PVC, unshielded, 5 m	YF2A14-050VB3XLEAX	2096235
	Head A: male connector, M12, 4-pin, straight Cable: unshielded	STE-1204-G	6009932
<b>Reflectors</b>			
	Fine triple reflector, screw connection, suitable for laser sensors, 52 mm x 62 mm, PM-MA/ABS, Screw-on, 2 hole mounting	P250F	5308843

## SICK AT A GLANCE

SICK is one of the leading manufacturers of intelligent sensors and sensor solutions for industrial applications. A unique range of products and services creates the perfect basis for controlling processes securely and efficiently, protecting individuals from accidents and preventing damage to the environment.

We have extensive experience in a wide range of industries and understand their processes and requirements. With intelligent sensors, we can deliver exactly what our customers need. In application centers in Europe, Asia and North America, system solutions are tested and optimized in accordance with customer specifications. All this makes us a reliable supplier and development partner.

Comprehensive services complete our offering: SICK LifeTime Services provide support throughout the machine life cycle and ensure safety and productivity.

For us, that is “Sensor Intelligence.”

## WORLDWIDE PRESENCE:

Contacts and other locations –[www.sick.com](http://www.sick.com)