



# IM08-1B5PS-ZWB

IM Standard

INDUCTIVE PROXIMITY SENSORS

**SICK**  
Sensor Intelligence.

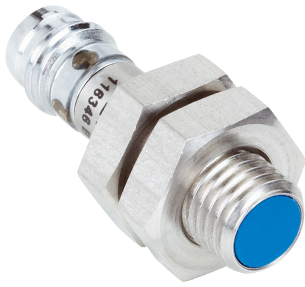

### Ordering information

| Type           | Part no. |
|----------------|----------|
| IM08-1B5PS-ZWB | 6021742  |

Other models and accessories → [www.sick.com/IM\\_Standard](http://www.sick.com/IM_Standard)

Illustration may differ



### Detailed technical data

#### Features

|                                       |                           |
|---------------------------------------|---------------------------|
| <b>Housing</b>                        | Cylindrical thread design |
| <b>Housing</b>                        | Standard design           |
| <b>Thread size</b>                    | M8 x 1                    |
| <b>Diameter</b>                       | Ø 8 mm                    |
| <b>Sensing range <math>S_n</math></b> | 1.5 mm                    |
| <b>Installation type</b>              | Flush                     |
| <b>Switching frequency</b>            | 5,000 Hz                  |
| <b>Connection type</b>                | Cable, 3-wire, 5 m        |
| <b>Switching output</b>               | PNP                       |
| <b>Output function</b>                | NO                        |
| <b>Electrical wiring</b>              | DC 3-wire                 |
| <b>Enclosure rating</b>               | IP67 <sup>1)</sup>        |

<sup>1)</sup> According to EN 60529.

#### Mechanics/electronics

|  |                                   |
|--|-----------------------------------|
| <b>Supply voltage</b>                          | 10 V DC ... 30 V DC               |
| <b>Ripple</b>                                  | ≤ 20 % <sup>1)</sup>              |
| <b>Voltage drop</b>                            | ≤ 2 V <sup>2)</sup>               |
| <b>Time delay before availability</b>          | ≤ 10 ms                           |
| <b>Hysteresis</b>                              | ≤ 10 %                            |
| <b>Reproducibility</b>                         | ≤ 5 % <sup>3)</sup> <sup>4)</sup> |
| <b>Temperature drift (of <math>S_n</math>)</b> | ± 10 %                            |

<sup>1)</sup> Of  $V_S$ .

<sup>2)</sup> At  $I_a$  max.

<sup>3)</sup> Supply voltage  $U_B$  and constant ambient temperature  $T_a$ .

<sup>4)</sup> Of  $S_r$ .

|  |                                  |
|--|----------------------------------|
| <b>EMC</b>                                 | According to EN 60947-5-2        |
| <b>Continuous current <math>I_a</math></b> | $\leq 200$ mA                    |
| <b>Cable material</b>                      | PVC                              |
| <b>Conductor size</b>                      | 0.14 mm <sup>2</sup>             |
| <b>Short-circuit protection</b>            | ✓                                |
| <b>Reverse polarity protection</b>         | ✓                                |
| <b>Power-up pulse protection</b>           | ✓                                |
| <b>Shock and vibration resistance</b>      | 30 g, 11 ms / 10 ... 55 Hz, 1 mm |
| <b>Ambient operating temperature</b>       | -25 °C ... +70 °C                |
| <b>Housing material</b>                    | Brass, Nickel-plated brass       |
| <b>Sensing face material</b>               | Plastic                          |
| <b>Housing length</b>                      | 16 mm                            |
| <b>Thread length</b>                       | 16 mm                            |
| <b>Tightening torque, max.</b>             | 4 Nm                             |

1) Of  $V_S$ .

2) At  $I_a$  max.

3) Supply voltage  $U_B$  and constant ambient temperature  $T_a$ .

4) Of  $S_r$ .

#### Reduction factors

|                                    |      |
|------------------------------------|------|
| <b>Stainless steel (V4A, 316L)</b> | 0.78 |
| <b>Aluminum (Al)</b>               | 0.38 |
| <b>Copper (Cu)</b>                 | 0.29 |
| <b>Brass (Br)</b>                  | 0.49 |

#### Installation note

|               |                                       |
|---------------|---------------------------------------|
| <b>Remark</b> | Associated graphic see "Installation" |
| <b>A</b>      | 3.25 mm                               |
| <b>B</b>      | 8 mm                                  |
| <b>C</b>      | 8 mm                                  |
| <b>D</b>      | 4.5 mm                                |
| <b>E</b>      | 0 mm                                  |
| <b>F</b>      | 12 mm                                 |

#### Classifications

|                     |          |
|---------------------|----------|
| <b>ECLASS 5.0</b>   | 27270101 |
| <b>ECLASS 5.1.4</b> | 27270101 |
| <b>ECLASS 6.0</b>   | 27270101 |
| <b>ECLASS 6.2</b>   | 27270101 |
| <b>ECLASS 7.0</b>   | 27270101 |
| <b>ECLASS 8.0</b>   | 27270101 |
| <b>ECLASS 8.1</b>   | 27270101 |
| <b>ECLASS 9.0</b>   | 27270101 |
| <b>ECLASS 10.0</b>  | 27270101 |

|                       |          |
|-----------------------|----------|
| <b>ECLASS 11.0</b>    | 27270101 |
| <b>ECLASS 12.0</b>    | 27274001 |
| <b>ETIM 5.0</b>       | EC002714 |
| <b>ETIM 6.0</b>       | EC002714 |
| <b>ETIM 7.0</b>       | EC002714 |
| <b>ETIM 8.0</b>       | EC002714 |
| <b>UNSPSC 16.0901</b> | 39122230 |

### Installation note

Non-flush installation

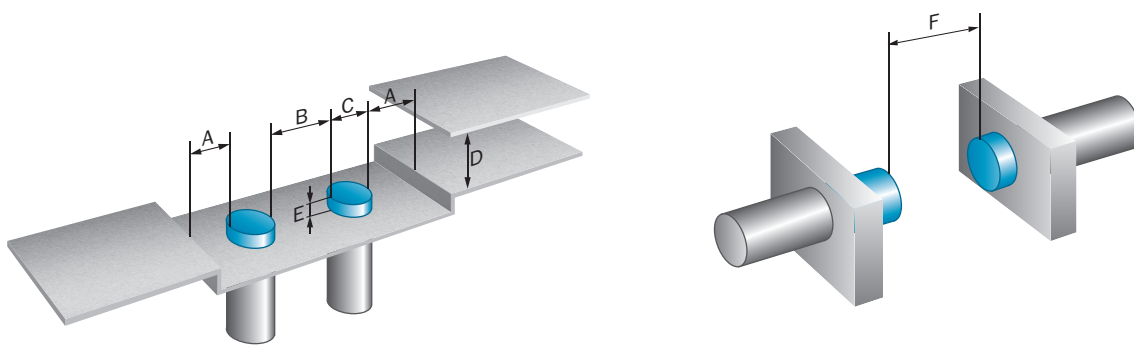

### Connection type

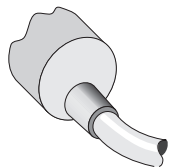

### Connection diagram

Cd-001

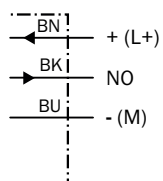

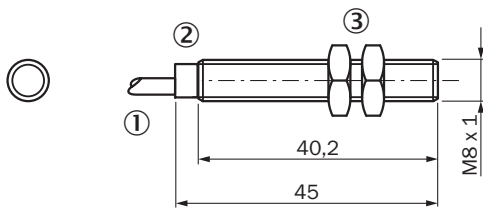

Dimensional drawing (Dimensions in mm (inch))



- ① Connection
- ② Display LED
- ③ Fastening nuts (2x); width across 13, metal

Recommended accessories

Other models and accessories → [www.sick.com/IM\\_Standard](http://www.sick.com/IM_Standard)

|   | Brief description   | Type       | Part no. |
|---|---|------------|----------|
| <b>Mounting brackets and plates</b>   |   |            |          |
|    | Mounting plate for M8 sensors, steel, zinc coated, without mounting hardware  | BEF-WG-M08 | 5321722  |
|   | Mounting bracket for M8 sensors, steel, zinc coated, without mounting hardware  | BEF-WN-M08 | 5321721  |
| <b>Terminal and alignment brackets</b>  |   |            |          |
|  | Clamping block for round sensors M8, without fixed stop, plastic (PA12), glass-fiber reinforced, mounting hardware included | BEF-KH-M08 | 2051477  |

## SICK AT A GLANCE

SICK is one of the leading manufacturers of intelligent sensors and sensor solutions for industrial applications. A unique range of products and services creates the perfect basis for controlling processes securely and efficiently, protecting individuals from accidents and preventing damage to the environment.

We have extensive experience in a wide range of industries and understand their processes and requirements. With intelligent sensors, we can deliver exactly what our customers need. In application centers in Europe, Asia and North America, system solutions are tested and optimized in accordance with customer specifications. All this makes us a reliable supplier and development partner.

Comprehensive services complete our offering: SICK LifeTime Services provide support throughout the machine life cycle and ensure safety and productivity.

For us, that is “Sensor Intelligence.”

## WORLDWIDE PRESENCE:

Contacts and other locations –[www.sick.com](http://www.sick.com)