



# VSPI-4F2411

Inspector

2D MACHINE VISION

**SICK**  
Sensor Intelligence.



### Ordering information

Type	Part no.
VSPI-4F2411	1054705

Other models and accessories → [www.sick.com/Inspector](http://www.sick.com/Inspector)



### Detailed technical data

#### Features

<b>Task</b>	Presence inspection Quality check
<b>Technology</b>	2D snapshot
<b>Product category</b>	Configurable
<b>Toolkit</b>	Object locator Contour Pixel counter Edge pixel counter Pattern
<b>Sensor</b>	CMOS matrix sensor, grayscale values
<b>Optical focus</b>	Adjustable focus (manually)
<b>Working distance</b>	≥ 50 mm
<b>Operating distance with internal illumination</b>	50 mm ... 200 mm
<b>Field of view of internal illumination</b>	22 mm x 15 mm ... 79 mm x 58 mm
<b>Illumination</b>	Integrated
<b>Illumination color</b>	Infrared,
<b>LED class</b>	Risk-free group (no danger, IEC62471: 2006)
<b>Spectral range</b>	Approx. 370 nm ... 900 nm
<b>Offline support</b>	Emulator
<b>Lens</b>	S-mount
	Optical format 1/3"
	Focal length 10 mm

#### Mechanics/electronics

<b>Connection type</b>	M12, 12-pin male connector M12, 4-pin female connector
<b>Supply voltage</b>	24 V DC, ± 20 %

<sup>1)</sup> With front window mounted.

<b>Ripple</b>	< 5 V <sub>pp</sub>
<b>Current consumption</b>	< 450 mA, without output load
<b>Enclosure rating</b>	IP67 <sup>1)</sup>
<b>Housing material</b>	Aluminum
<b>Window material</b>	PMMA
<b>Weight</b>	350 g
<b>Dimensions (L x W x H)</b>	100 mm x 53 mm x 38 mm

<sup>1)</sup> With front window mounted.

## Performance

<b>Sensor resolution</b>	640 px x 480 px
<b>Scan/frame rate</b>	40 fps <sup>1)</sup>
<b>Number of inspections</b>	32
<b>Reference images</b>	32 objects

<sup>1)</sup> Max. 250 fps.

## Interfaces

<b>EtherNet/IP™</b>	✓
Data transmission rate	100 Mbit/s
<b>Operator interfaces</b>	Inspector Viewer
<b>Configuration software</b>	SOPAS ET
<b>Data storage and retrieval</b>	Log for 30 images, record images on PC, store images to FTP
<b>Ethernet communication</b>	EtherNet/IP™
<b>Digital input</b>	4 inputs (24 V)
<b>Configurable inputs</b>	External trigger, encoder input, External teach, reference object selection
<b>Digital output</b>	3 digital outputs, 24 V (B-type)
<b>Configurable outputs</b>	Output by logical expressions, Additional image storage possibility via FTP
<b>Output current</b>	≤ 100 mA
<b>Standard outputs</b>	No object detected, Everything OK, Detail error
<b>Maximum encoder frequency</b>	40 kHz
<b>External illumination</b>	5 V TTL
<b>I/O box extension</b>	5 x inputs for object selection, 16 outputs

## Ambient data

<b>Shock load</b>	EN 60068-2-27
<b>Vibration load</b>	IEC 60068-2-6
<b>Ambient operating temperature</b>	0 °C ... +45 °C <sup>1)</sup>
<b>Storage temperature</b>	-20 °C ... +70 °C <sup>1)</sup>

<sup>1)</sup> Relative humidity: 35% ... 85%, 95% in storage.

## Classifications

<b>ECLASS 5.0</b>	27310205
<b>ECLASS 5.1.4</b>	27310205

<b>ECLASS 6.0</b>	27310205
<b>ECLASS 6.2</b>	27310205
<b>ECLASS 7.0</b>	27310205
<b>ECLASS 8.0</b>	27310205
<b>ECLASS 8.1</b>	27310205
<b>ECLASS 9.0</b>	27310205
<b>ECLASS 10.0</b>	27310205
<b>ECLASS 11.0</b>	27310205
<b>ECLASS 12.0</b>	27310205
<b>ETIM 5.0</b>	EC001820
<b>ETIM 6.0</b>	EC001820
<b>ETIM 7.0</b>	EC001820
<b>ETIM 8.0</b>	EC001820
<b>UNSPSC 16.0901</b>	43211731

### Dimensional drawing (Dimensions in mm (inch))

Standard

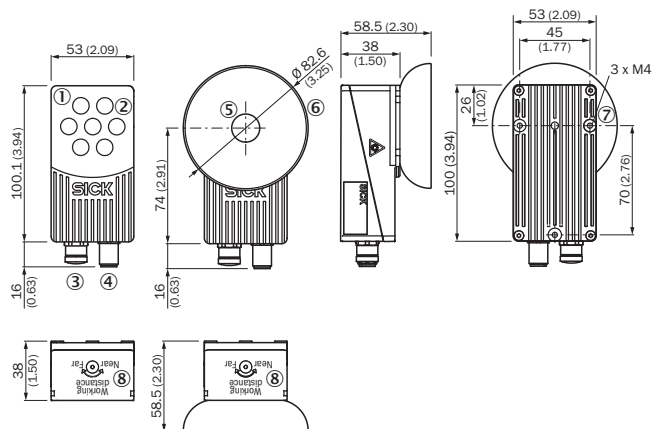

- ① Front screen: standard, flex
- ② Ring lighting
- ③ Ethernet connection M12, 4-pin, female
- ④ Power connection M12, 12-pin, male
- ⑤ Front screen: dome
- ⑥ Dome light
- ⑦ Mounting hole M4
- ⑧ Focus

## Field of view

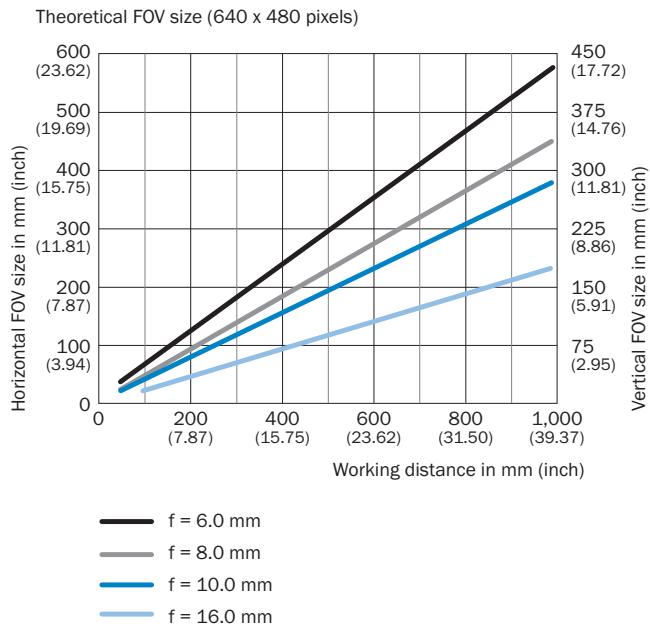

## Connection type

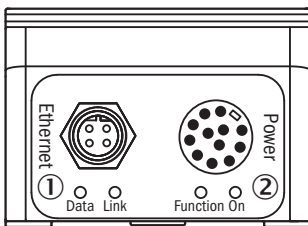

- ① Ethernet connection M12, 4-pin, female
- ② Power connection M12, 12-pin, male

### Connection diagram

M12 connection diagram, 12-pin

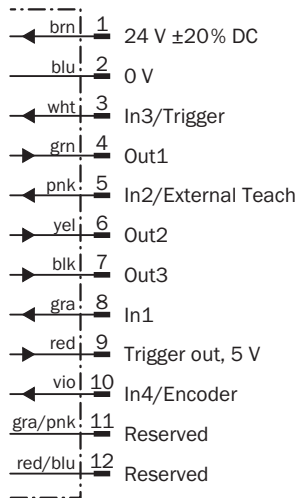



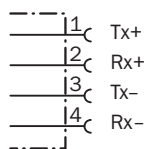

Ethernet connection diagram



### Recommended accessories

Other models and accessories → [www.sick.com/Inspector](http://www.sick.com/Inspector)

	Brief description	Type	Part no.
<b>Lenses and accessories</b>			
	Exchangeable lens, focal length 6 mm, Round connector M12 x 0.5	OBJ-B06025BA	2049668
	Exchangeable lens, focal length 16 mm, including spacer ring, Round connector M12 x 0.5	OBJ-B16018BA	2049418
<b>Optical filters</b>			
	Visible block filter for variants with exchangeable lens and front window, PMMA	Inspector Flex visible block filter	2073707
	Visible block filter for variants with exchangeable lens and front window, glass	Inspector Flex visible block filter	2071856
<b>Plug connectors and cables</b>			
	<ul style="list-style-type: none"> <li><b>Connection type head A:</b> Male connector, M12, 4-pin, straight, D-coded</li> <li><b>Connection type head B:</b> Male connector, RJ45, 4-pin, straight</li> <li><b>Signal type:</b> Ethernet, PROFINET</li> <li><b>Cable:</b> 2 m, 4-wire, PUR, halogen-free</li> <li><b>Description:</b> Ethernet, PROFINET, shielded</li> <li><b>Application:</b> Drag chain operation, Zones with oils and lubricants</li> </ul>	YM2D24-020PN1MRJA4	2106182

	Brief description	Type	Part no.
Others			
	<ul style="list-style-type: none"> <li>• <b>Connection type head A:</b> Female connector, M12, 12-pin, straight</li> <li>• <b>Connection type head B:</b> Flying leads</li> <li>• <b>Signal type:</b> Sensor/actuator cable</li> <li>• <b>Cable:</b> 5 m, 12-wire, cable ends blue/red, gray/pink and red isolated separately, PUR, halogen-free</li> <li>• <b>Description:</b> Sensor/actuator cable, shielded</li> <li>• <b>Connection systems:</b> Flying leads</li> </ul>	D0L-1212-G05MAS01	6036556

### Recommended services

Additional services → [www.sick.com/Inspector](http://www.sick.com/Inspector)

	Type	Part no.
Commissioning		
<ul style="list-style-type: none"> <li>• <b>Product area:</b> 2D machine vision</li> <li>• <b>Range of services:</b> Inspection of connection, fine adjustment, optimization of parameters of SICK product as well as tests, set-up of previously defined functions of image settings, object locator, detailed inspections, output settings and results</li> <li>• <b>Travel expenses:</b> The prices do not include travel costs such as hotel, flight, travel time and expenses.</li> <li>• <b>Duration:</b> Additional work will be invoiced separately</li> </ul>	Inspector commissioning	1612238
Maintenance		
<ul style="list-style-type: none"> <li>• <b>Product area:</b> 2D machine vision</li> <li>• <b>Range of services:</b> Inspection, analysis and restoring of defined functions, set-up of previously defined functions of image settings, object locator, detailed inspections, output settings and results</li> <li>• <b>Duration:</b> Additional work will be invoiced separately</li> <li>• <b>Travel expenses:</b> The prices do not include travel costs such as hotel, flight, travel time and expenses.</li> </ul>	Inspector maintenance	1612242
Extended warranty		
<ul style="list-style-type: none"> <li>• <b>Product area:</b> Identification solutions, machine vision, Detection and ranging solutions, safety camera sensors, Safety laser scanners, Safety radar sensors</li> <li>• <b>Range of services:</b> The services correspond to the scope of the statutory manufacturer warranty (SICK general terms of delivery).</li> <li>• <b>Duration:</b> Five-year warranty from delivery date.</li> </ul>	Extended warranty for a total of five years from delivery date	1680671

## SICK AT A GLANCE

SICK is one of the leading manufacturers of intelligent sensors and sensor solutions for industrial applications. A unique range of products and services creates the perfect basis for controlling processes securely and efficiently, protecting individuals from accidents and preventing damage to the environment.

We have extensive experience in a wide range of industries and understand their processes and requirements. With intelligent sensors, we can deliver exactly what our customers need. In application centers in Europe, Asia and North America, system solutions are tested and optimized in accordance with customer specifications. All this makes us a reliable supplier and development partner.

Comprehensive services complete our offering: SICK LifeTime Services provide support throughout the machine life cycle and ensure safety and productivity.

For us, that is “Sensor Intelligence.”

## WORLDWIDE PRESENCE:

Contacts and other locations –[www.sick.com](http://www.sick.com)