

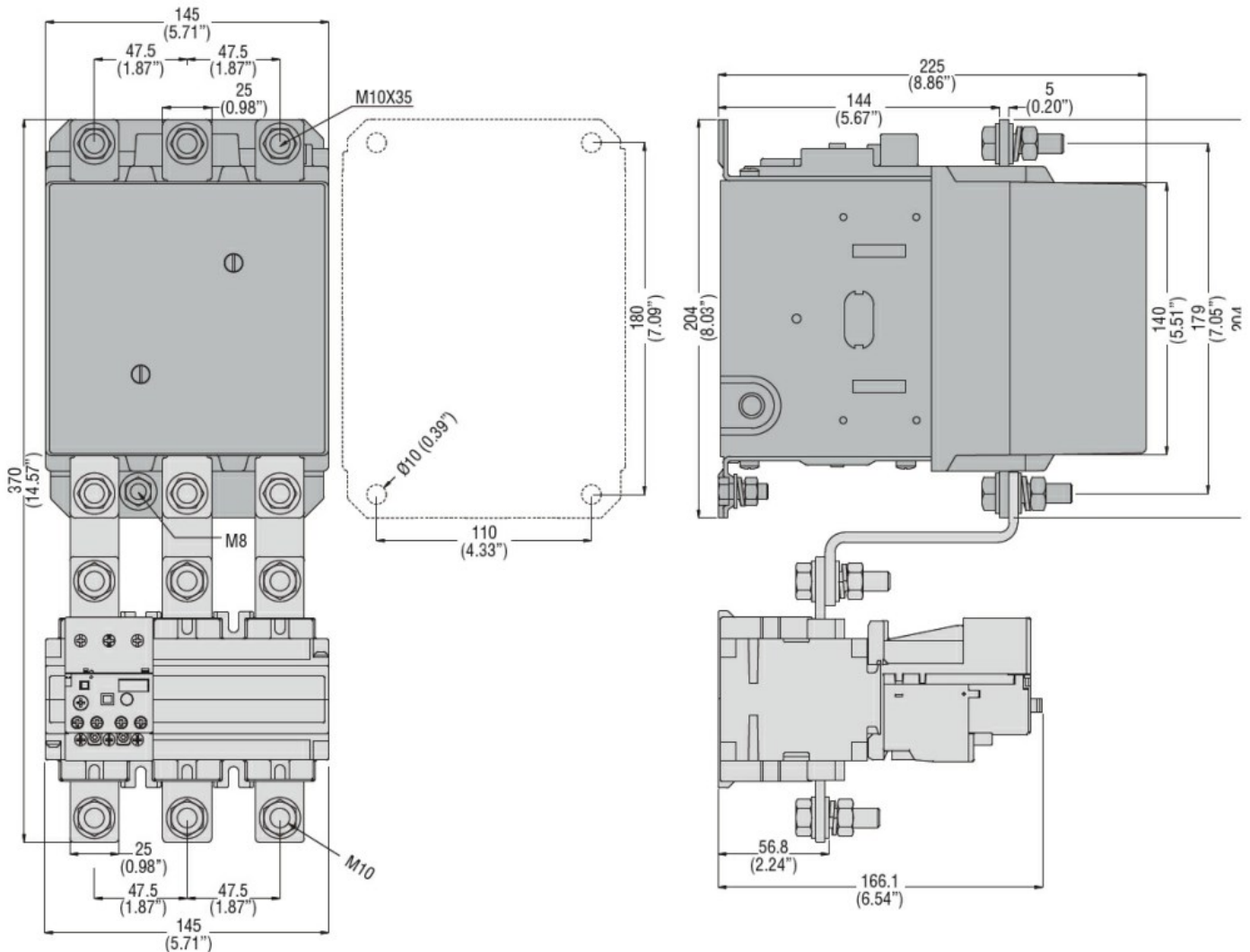

**Contact characteristics**

Number of poles	Nr.	3
Operational current Ie		
	AC-4 (400V)	A 115
Rated operational power AC-3 (T≤55°C)		
	400V	kW 140
Making capacity (RMS value)		A 2750
Breaking capacity at voltage		
	440V	A 2500
	500V	A 2250
	690V	A 2200

**Dimensions**



**Wiring diagrams**

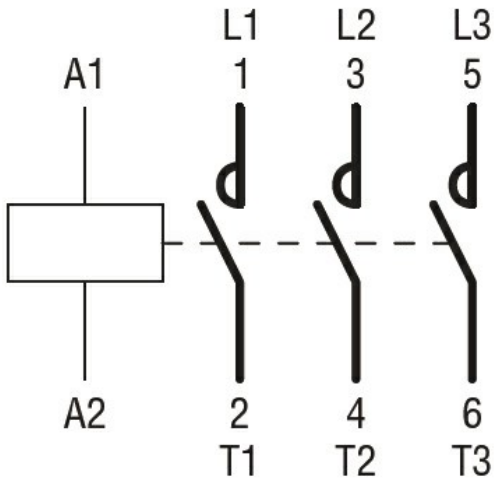

**Certifications and compliance**

Compliance

CSA C22.2 n° 60947-1

CSA C22.2 n° 60947-4-1

IEC/EN 60947-1

IEC/EN 60947-4-1

UL 60947-1

UL 60947-4-1

Certificates

CCC

cULus

EAC