



Coffret réseau optimum manuel PoE

4 132 65 - 4 182 65

Notice d'installation



FLASHÉZ-MOI



et accédez aux compléments d'informations d'installation

■ PRESENTATION DU COFFRET RESEAU OPTIMUM MANUEL

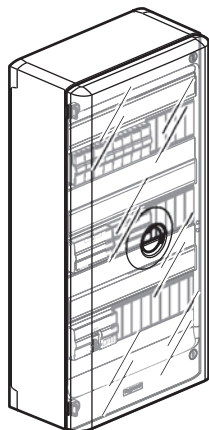

4 132 65

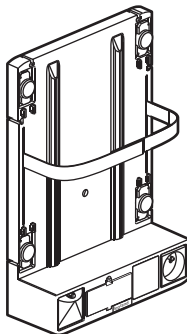

4 182 65

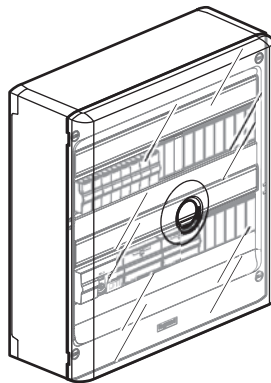

Permet de répondre aux exigences des normes NF C 15-100 et XP C 90-483 qui prennent en compte l'arrêté sur les réseaux de communication

Coffret prêt à recevoir l'arrivée fibre optique

⚠ Consignes de sécurité

Ce produit doit être installé conformément aux règles d'installation et de préférence par un électricien qualifié. Une installation et une utilisation incorrectes peuvent entraîner des risques de choc électrique ou d'incendie. Avant d'effectuer l'installation, lire la notice, tenir compte du lieu de montage spécifique au produit.

Ne pas ouvrir, démonter, altérer ou modifier l'appareil sauf mention particulière indiquée dans la notice. Tous les produits Legrand doivent exclusivement être ouverts et réparés par du personnel formé et habilité par Legrand. Toute ouverture ou réparation non autorisée annule l'intégralité des responsabilités, droits à remplacement et garanties.

Utiliser exclusivement les accessoires de la marque Legrand.

إرشادات الأمان: ⚠

يجب تركيب هذا المنتج طبقاً لقواعد التركيب ويفضل أن يقوم بالتركيب كهربائي مؤهل. فقد يؤدي التركيب والاستخدام غير صحيح إلى مخاطر التعرض لصدمة كهربائية أو نشوب حريق. اقرأ النشرة قبل التركيب. وأفرّد مكاناً لتركيب المنتج خاصاً به. لا تفتح أو تفك أو تعدّل أو تخوّر المنتج ما لم يُشر إلى ذلك بشكل محدد في النشرة. فكل منتجات Legrand يجب فتحها وإصلاحها حصراً من قبل فنيين مدربين ومؤهلين لدى Legrand. وكل فتح أو إصلاح غير مسموح به يُبطل المسؤوليات وحقوق الاستبدال والضمانات. لا تستخدم سوى إكسسوارات من ماركة Legrand حصراً.



Ce symbole indique qu'en fin de vie, le produit doit être collecté séparément des autres déchets et remis à un centre de collecte agréé dans le respect des normes et dispositions légales en vigueur dans les pays de l'UE, pour prévenir les effets indésirables sur l'environnement et la santé des personnes. L'élimination abusive du produit est passible des sanctions prévues par la loi. Il est recommandé de s'assurer que dans le pays où le produit est utilisé, ce dernier est soumis aux réglementations WEEE/DEEE.

• Nota :

- La sécurité de cet appareil n'est assurée que si l'utilisateur respecte l'ensemble des instructions fournies dans cette notice.
- Il est très fortement recommandé d'installer systématiquement un parafoudre de puissance dans le tableau d'abonné (NFC 15-100 § 444.3.3), ainsi qu'un parafoudre téléphonique analogique.
- L'installation doit être conforme à la norme NFC 15-100 (et au guide 15-443 pour les parafoudres) :
- cet appareil doit être installé dans un circuit protégé par un disjoncteur 10A (ou 16A)
- parafoudre de puissance dans le tableau d'abonné
- parafoudre téléphonique analogique

■ COMPOSITION DU COFFRET

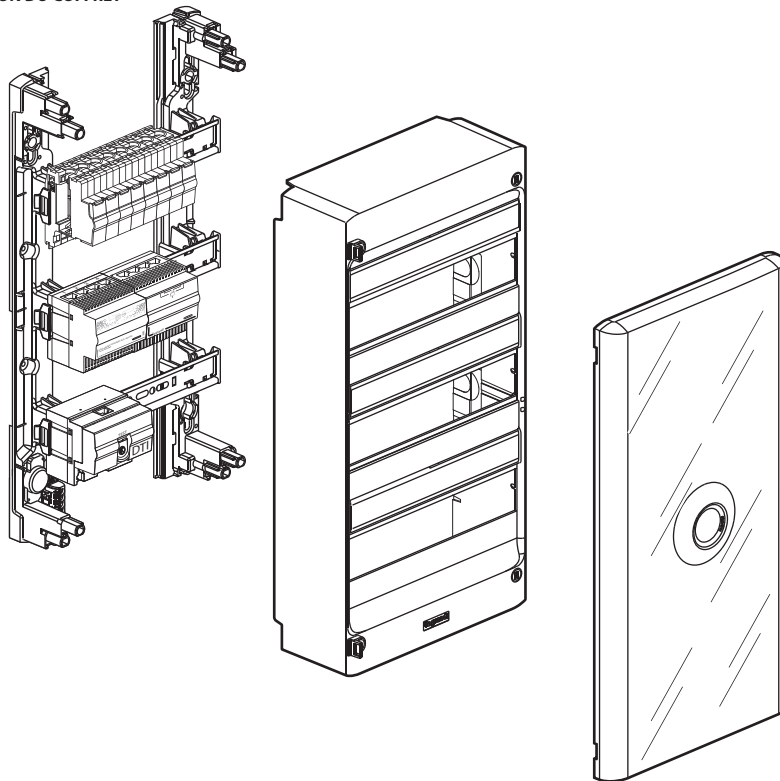

■ COMPOSANTS PRÉ-INSTALLÉS

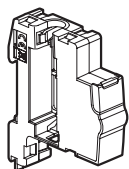

x 8

Module de brassage

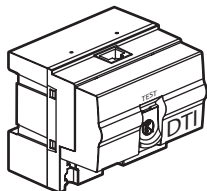

DTI RJ 45
modulaire

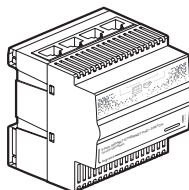

Switch Gigabit PoE
5 ports RJ 45

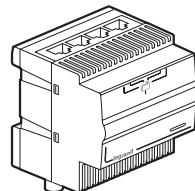

Répartiteur amplificateur
TV-SAT sur RJ
4 sorties RJ 45

■ COMPOSANTS A INSTALLER

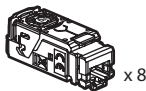

Connecteurs RJ 45 Cat 6A STP x 8

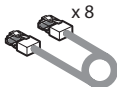

Cordons de brassage RJ 45 5/FTP x 8

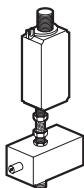

Kit de réglage TV

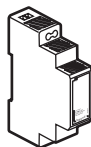

Alimentation 9 V 4 130 17



Alimentation 48 V 4 131 10

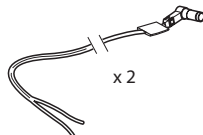

Cordon simple x 2

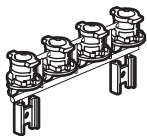

Grappe de fixation



Obturbateurs x 26 (4 132 65) x 18 (4 182 65)

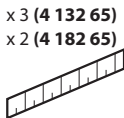

Bandes d'étiquettes de plastron x 3 (4 132 65) x 2 (4 182 65)



Porte de coffret



Fiche F x 3

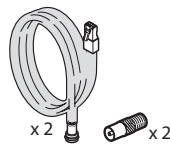

Cordons télévision RJ 45/F + adaptateur IEC x 2

■ ACCESSOIRES POUR BOX OPERATEUR

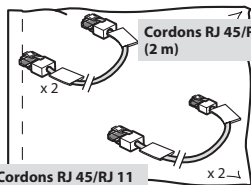

Cordons RJ 45/RJ 45 (2 m) x 2

Cordons RJ 45/RJ 11 (2 m) x 2

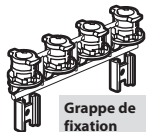

Grappe de fixation



Grappe de bouchons

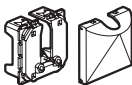

Sortie de câble



Obturbateur



Prise 2 P+T - 16 A

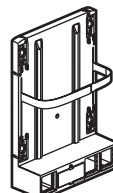

Support box opérateur

■ SCHÉMA DE PRINCIPE

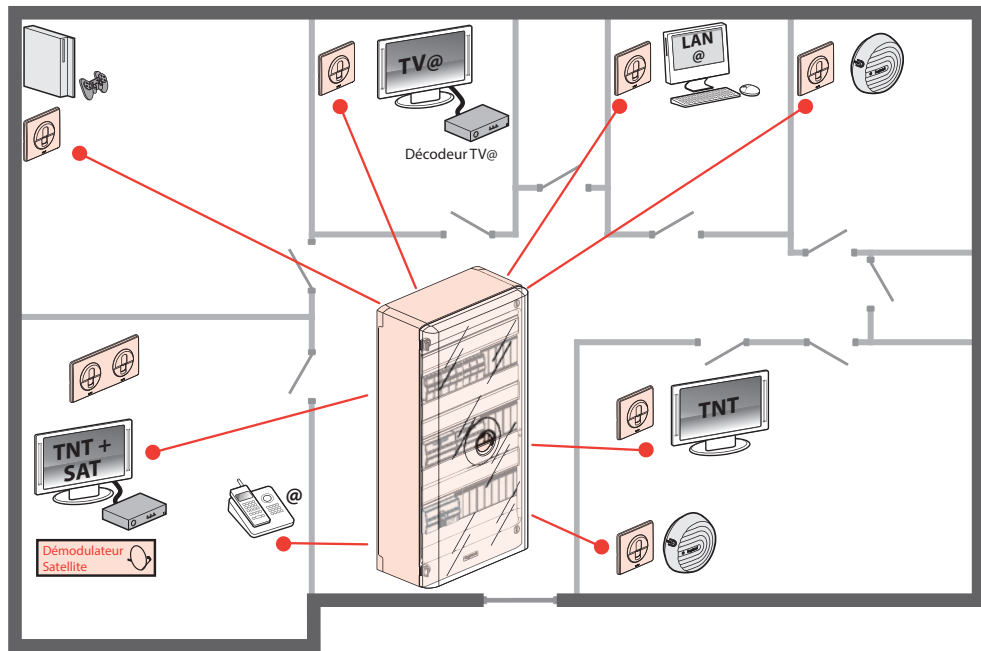

■ FIXATION

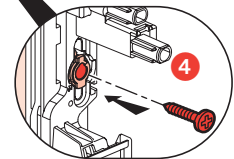
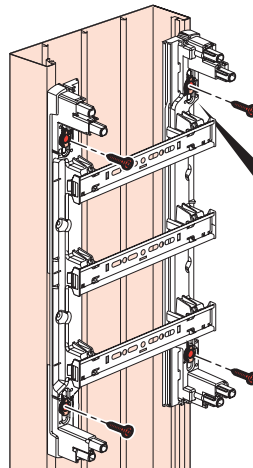
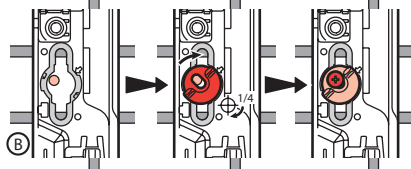
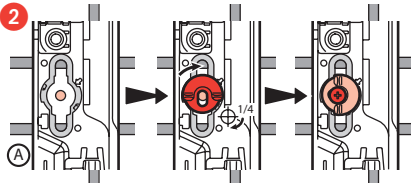
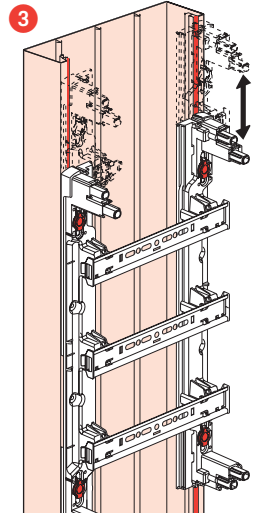
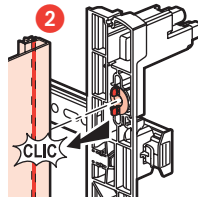
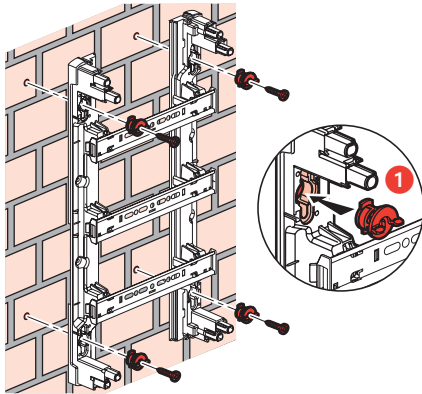
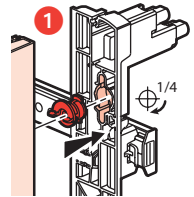
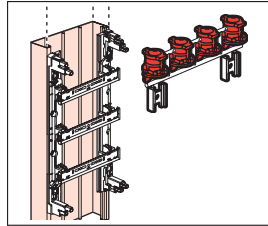
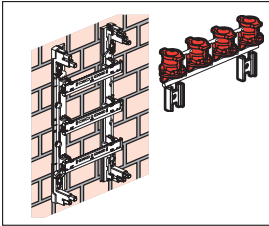
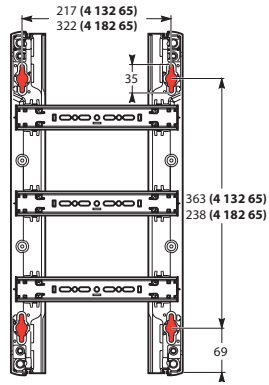

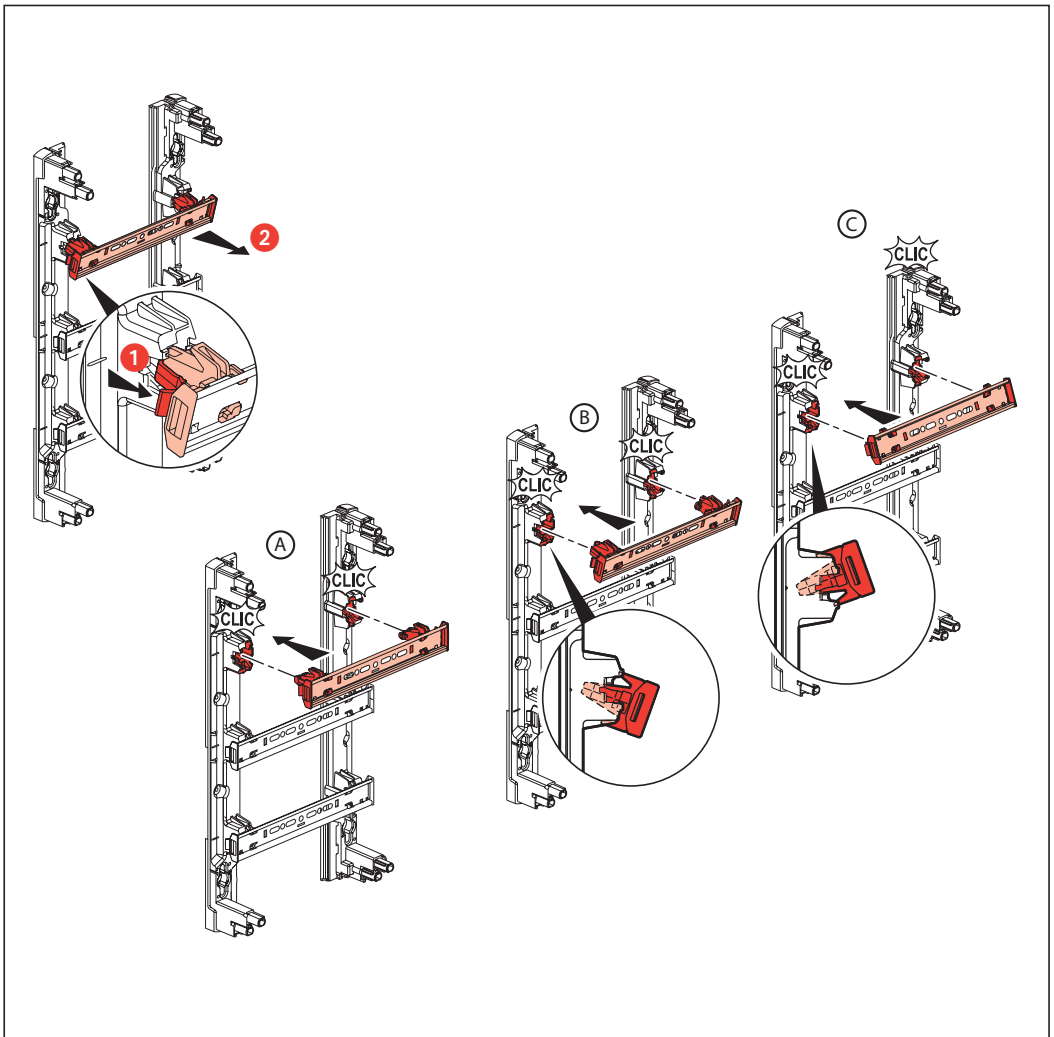

■ DISPOSITION DES DÉPARTS RJ 45

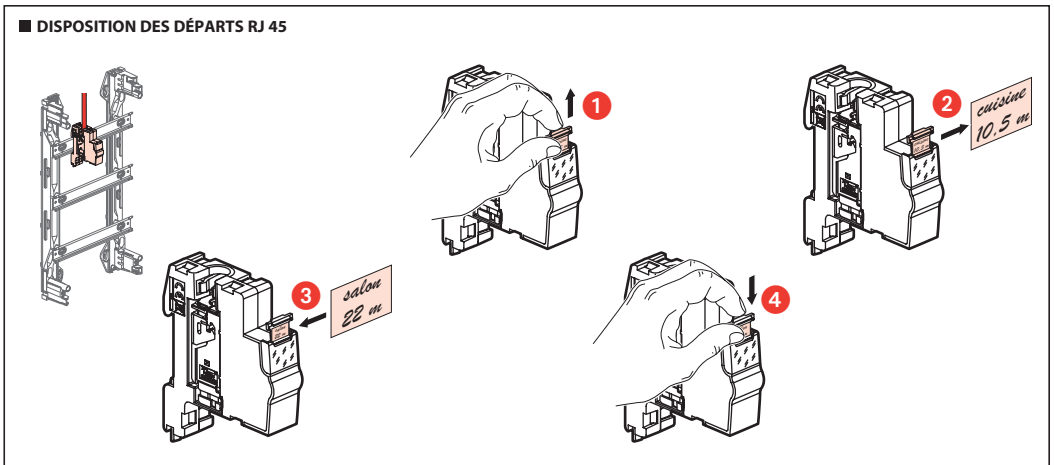

■ CÂBLAGE

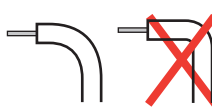
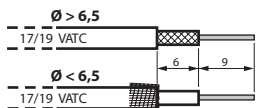
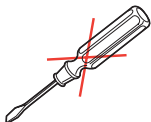
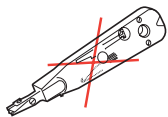
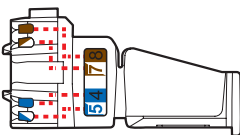
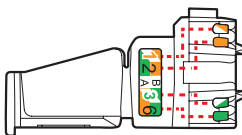
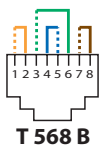
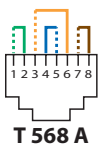
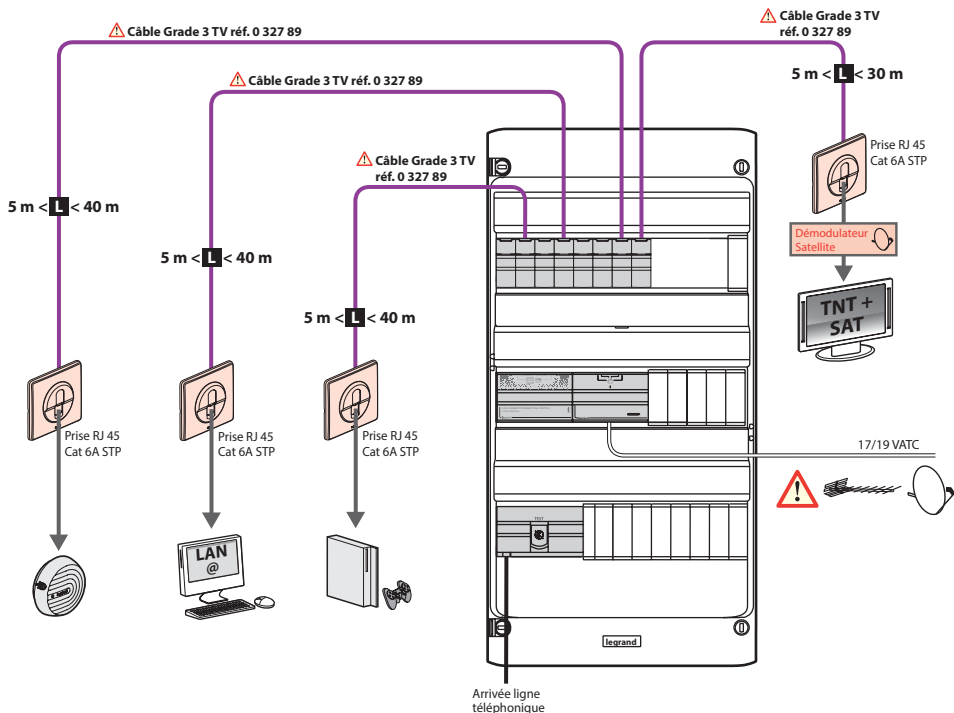

■ PRÉPARATION DU CÂBLE GRADE 3 TV RÉF. 0 327 89

0 332 62

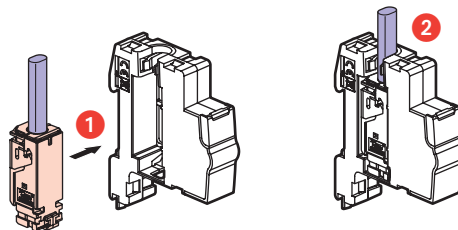
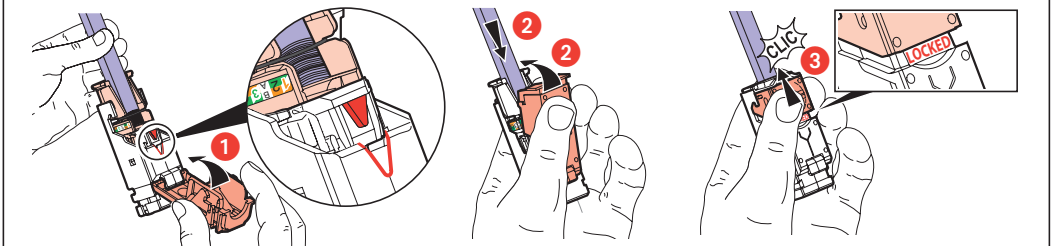
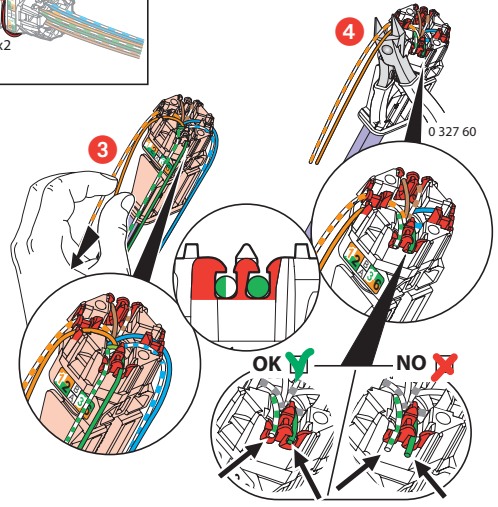
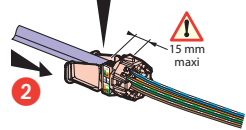
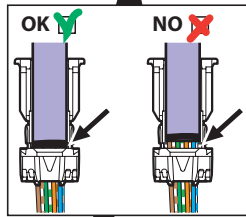
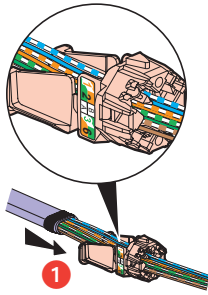
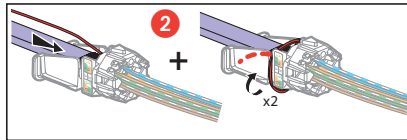
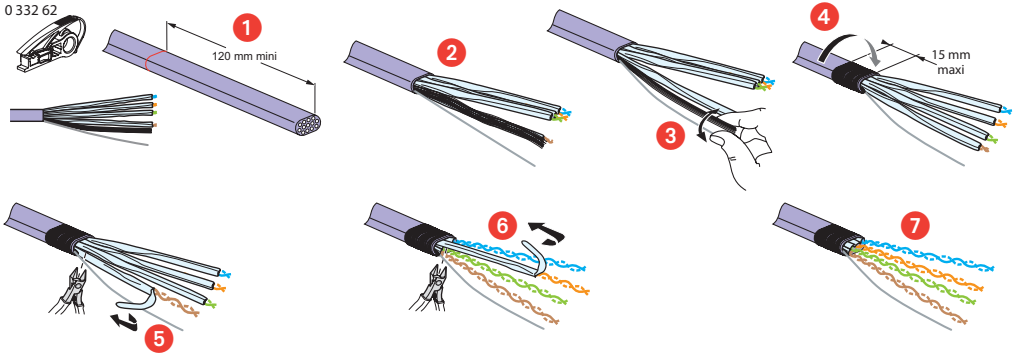



Installer l'alimentation dans le tableau électrique

■ MISE EN OEUVRE DU SWITCH PoE

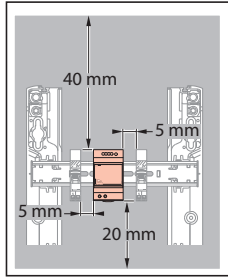

■ MISE EN OEUVRE DU REPARTITEUR

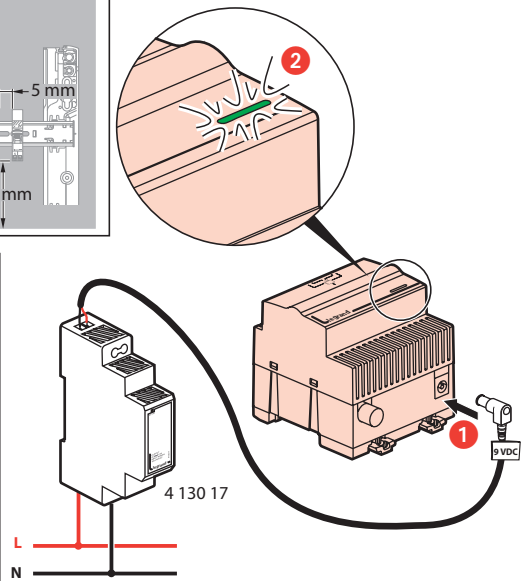
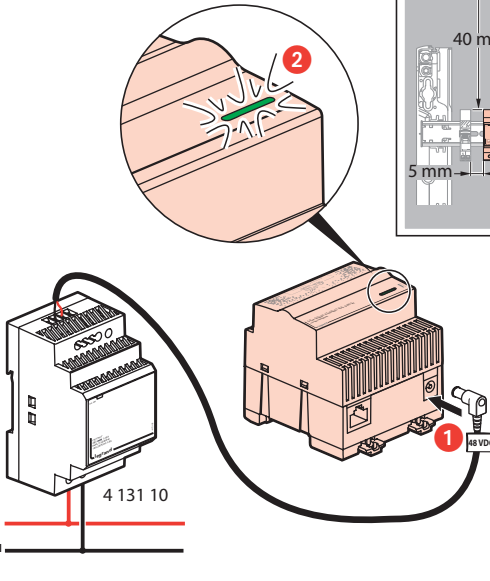

■ RACCORDEMENT ARRIVÉE TÉLÉPHONE SUR DTI

