

Pact Series

MasterPact MTZ1 IEC Circuit Breakers and Switch-Disconnectors from 630 to 1600 A

User Guide

Pact Series offers world-class breakers and switches.

DOCA0100EN-05
06/2022



Legal Information

The Schneider Electric brand and any trademarks of Schneider Electric SE and its subsidiaries referred to in this guide are the property of Schneider Electric SE or its subsidiaries. All other brands may be trademarks of their respective owners.

This guide and its content are protected under applicable copyright laws and furnished for informational use only. No part of this guide may be reproduced or transmitted in any form or by any means (electronic, mechanical, photocopying, recording, or otherwise), for any purpose, without the prior written permission of Schneider Electric.

Schneider Electric does not grant any right or license for commercial use of the guide or its content, except for a non-exclusive and personal license to consult it on an "as is" basis. Schneider Electric products and equipment should be installed, operated, serviced, and maintained only by qualified personnel.

As standards, specifications, and designs change from time to time, information contained in this guide may be subject to change without notice.

To the extent permitted by applicable law, no responsibility or liability is assumed by Schneider Electric and its subsidiaries for any errors or omissions in the informational content of this material or consequences arising out of or resulting from the use of the information contained herein.

As part of a group of responsible, inclusive companies, we are updating our communications that contain non-inclusive terminology. Until we complete this process, however, our content may still contain standardized industry terms that may be deemed inappropriate by our customers.

Table of Contents

Safety Information	5
About the Book.....	7
MasterPact MTZ1 Description	9
Pact Series Master Range.....	10
MasterPact MTZ1 Range	11
Fixed Device	13
Drawout Device	17
Device Identification.....	23
MicroLogic X Control Unit: Description	26
Go2SE Landing Page	30
Operating Conditions	32
MasterPact MTZ1 Normal Operation	34
Device Operating Actions.....	35
Operating the Device	36
Control Modes	40
Opening the Device	46
Closing the Device	49
Resetting the Circuit Breaker	52
Engaging the ERMS Function	53
Operating Accessories	56
Drawout Device Racking Actions	63
Drawout MasterPact MTZ1 Device Status.....	64
Disconnecting the Drawout Device	68
Connecting the Drawout Device	70
Removing the Drawout Device.....	72
Installing the Drawout Device in the Chassis	74
Device Locking Actions	77
Locking the Pushbuttons	78
Locking the Device in Open Position with Padlocks	80
Locking the Device in Open Position with Keylocks.....	82
Chassis Locking in Disconnected Position	85
Chassis Locking in Any Position.....	90
Locking the Safety Shutters	95
Device Interlocking Actions	96
Mismatch Protection	97
VPEC Door Interlock.....	99
VPOC Open-door Racking Interlock	102
IPA Cable-type Door Interlock.....	105
Mechanical Interlocking for Transfer Switches.....	106
MasterPact MTZ Critical Cases	108
Finding the Cause of a Trip or an Alarm in Critical Cases	109
Resetting the Circuit Breaker After a Trip Due to an Electrical Fault	113
Resetting the Circuit Breaker After a Trip Due to an Incident Detected by the MicroLogic X Self-tests	116
Diagnosing Alarms	118
Diagnosing Error Messages	125
MasterPact MTZ Commissioning	127

Introduction to Commissioning.....	128
Inspection and MicroLogic X Settings.....	130
Tests	132
Communication Tests	136
Final Checks and Reporting	137
MasterPact MTZ Test Form	138
MasterPact MTZ Troubleshooting.....	141
Introduction to Troubleshooting.....	142
Troubleshooting: Chassis Operation	145
Troubleshooting: Unexpected Tripping	146
Troubleshooting: Mechanical Control Operations	147
Troubleshooting: Electrical Control Operations	148
Troubleshooting: Control Operations from EcoStruxure Power Device App	150
Troubleshooting: Control Operations from IO Module	152
Troubleshooting: Control Operations from FDM121 Display	154
Troubleshooting: Control Operations from EcoStruxure Power Commission Software	156
Troubleshooting: Control Operations from IFE/EIFE Webpages	158
Troubleshooting: Control Operations from Communication Network	160
Troubleshooting: Control Operations from FDM128 Display	162
Schneider Electric Green Premium™ Ecolabel.....	163
Schneider Electric Green Premium™ Ecolabel	164

Safety Information

Important Information

Read these instructions carefully, and look at the equipment to become familiar with the device before trying to install, operate, service, or maintain it. The following special messages may appear throughout this documentation or on the equipment to warn of potential hazards or to call attention to information that clarifies or simplifies a procedure.



The addition of this symbol to a “Danger” or “Warning” safety label indicates that an electrical hazard exists which will result in personal injury if the instructions are not followed.



This is the safety alert symbol. It is used to alert you to potential personal injury hazards. Obey all safety messages that follow this symbol to avoid possible injury or death.

DANGER

DANGER indicates a hazardous situation which, if not avoided, **will result in** death or serious injury.

WARNING

WARNING indicates a hazardous situation which, if not avoided, **could result in** death or serious injury.

CAUTION

CAUTION indicates a hazardous situation which, if not avoided, **could result in** minor or moderate injury.

NOTICE

NOTICE is used to address practices not related to physical injury.

Please Note

Electrical equipment should be installed, operated, serviced, and maintained only by qualified personnel. No responsibility is assumed by Schneider Electric for any consequences arising out of the use of this material.

A qualified person is one who has skills and knowledge related to the construction and operation of electrical equipment and its installation, and has received safety training to recognize and avoid the hazards involved.

Safety Notice

DANGER

HAZARD OF ELECTRIC SHOCK, EXPLOSION, OR ARC FLASH

- Apply appropriate personal protective equipment (PPE) and follow safe electrical work practices. See NFPA 70E, CSA Z462, NOM 029-STPS or local equivalent.
- This equipment must only be installed and serviced by qualified electrical personnel.
- Turn off all power supplying this equipment before working on or inside this equipment.
- Always use a properly rated voltage sensing device to confirm power is off.
- Put back all devices, doors, and covers before turning on power to this equipment.
- Beware of potential hazards, and carefully inspect the work area for tools and objects that may have been left inside the equipment.

Failure to follow these instructions will result in death or serious injury.

Cybersecurity Safety Notice

WARNING

POTENTIAL COMPROMISE OF SYSTEM AVAILABILITY, INTEGRITY, AND CONFIDENTIALITY

- Change default passwords at first use to help prevent unauthorized access to device settings, controls, and information.
- Disable unused ports/services and default accounts to help minimize pathways for malicious attackers.
- Place networked devices behind multiple layers of cyber defenses (such as firewalls, network segmentation, and network intrusion detection and protection).
- Use cybersecurity best practices (for example, least privilege, separation of duties) to help prevent unauthorized exposure, loss, modification of data and logs, or interruption of services.

Failure to follow these instructions can result in death, serious injury, or equipment damage.

About the Book

Document Scope

The aim of this guide is to provide users, installers, and maintenance personnel with technical information needed to operate MasterPact™ MTZ1 circuit breakers and switch-disconnectors, in compliance with the IEC standards.

Validity Note

This guide applies to MasterPact MTZ1 circuit breakers and switch-disconnectors.

This guide applies to MicroLogic™ X control units:

- With firmware version 004.000.000 or greater
- With hardware version 001.000.000 or greater

NOTE:

This guide also applies to MicroLogic™ Xi control units. A MicroLogic Xi control unit is a MicroLogic X control unit without Bluetooth low energy (BLE) communication.

The specific features of the MicroLogic Xi control units are described in the appendix in DOCA0102EN *MasterPact MTZ - MicroLogic X Control Unit - User Guide*.

Online Information

The information contained in this guide is likely to be updated at any time. Schneider Electric strongly recommends that you have the most recent and up-to-date version available on www.se.com/ww/en/download.

The technical characteristics of the devices described in this guide also appear online. To access the information online, go to the Schneider Electric home page at www.se.com.

Related Documents

Title of documentation	Reference number
<i>MasterPact MTZ – MicroLogic X Control Unit – User Guide</i>	DOCA0102EN
<i>MasterPact MTZ – Modbus Communication – User Guide</i>	DOCA0105EN
<i>MasterPact MTZ - IEC 61850 Communication Guide</i>	DOCA0162EN
<i>MasterPact MTZ - IEC Circuit Breakers and Switch-Disconnectors - Maintenance Guide</i>	DOCA0099EN
<i>MasterPact MTZ Catalogue</i>	LVPED216026EN
<i>MasterPact MTZ1 - Fixed IEC Circuit Breaker or Switch-Disconnecter - Instruction Sheet</i>	NVE35505
<i>MasterPact MTZ1 - Drawout IEC Circuit Breaker or Switch-Disconnecter - Instruction Sheet</i>	NVE35506
<i>Enerlin'X IO – Input/Output Application Module for One IEC Circuit Breaker – User Guide</i>	DOCA0055EN
<i>Enerlin'X IFE – Ethernet Switchboard Server – User Guide</i>	DOCA0084EN
<i>Enerlin'X IFE - Ethernet Interface for One IEC Circuit Breaker – User Guide</i>	DOCA0142EN
<i>Enerlin'X EIFE – Embedded Ethernet Interface for One MasterPact MTZ Drawout Circuit Breaker – User Guide</i>	DOCA0106EN
<i>Enerlin'X FDM121 – Front Display Module for One Circuit Breaker – User Guide</i>	DOCA0088EN

Title of documentation	Reference number
<i>Enerlin'X FDM128 – Ethernet Display for Eight Devices – User Guide</i>	DOCA0037EN
<i>ULP System (IEC Standard) – ULP (Universal Logic Plug) System – User Guide</i>	DOCA0093EN

You can download these technical publications and other technical information from our website at www.se.com/ww/en/download.

MasterPact MTZ1 Description

What's in This Part

Pact Series Master Range	10
MasterPact MTZ1 Range	11
Fixed Device	13
Drawout Device	17
Device Identification	23
MicroLogic X Control Unit: Description	26
Go2SE Landing Page	30
Operating Conditions	32

Pact Series Master Range

Future-proof your installation with Schneider Electric's low-voltage and medium-voltage Pact Series. Built on legendary Schneider Electric innovation, the Pact Series comprises world-class circuit breakers, switches, residual current devices and fuses, for all standard and specific applications. Experience robust performance with Pact Series within the EcoStruxure-ready switchgear, from 16 to 6300 A in low-voltage and up to 40.5 kV in medium-voltage.

MasterPact MTZ1 Range

Description

The MasterPact MTZ1 range of circuit breakers and switch-disconnectors offers current ratings from 630 A to 1600 A, for AC power systems up to 690 Vac. The range is covered by one frame size.

MasterPact MTZ1 devices are available in the following power systems:

- 3-pole (3P)
- 4-pole (4P)

Devices are available in the following installation types:

- Fixed-mounted devices
- Drawout devices

Convention

In this guide, the term *MasterPact MTZ device* covers circuit breakers and switch-disconnectors.

Circuit Breakers

The following performance levels (I_{cu} at 415 Vac) are available:

- H1: standard short-circuit level (42 kA) with total selectivity
- H2: high short-circuit level (50 kA) with high selectivity (42 kA)
- H3: very high short-circuit level (66 kA) with very high selectivity (50 kA)
- L1: extremely high short-circuit level (150 kA) with strong current limitation and selectivity (10 kA)

NOTE: The values above correspond to a 415 Vac network, for higher voltage levels the values can be different. Refer to LVPED216026EN *MasterPact MTZ Catalogue*.

NOTE: The arc chutes on the MasterPact MTZ1 H3 are built-in and cannot be removed.

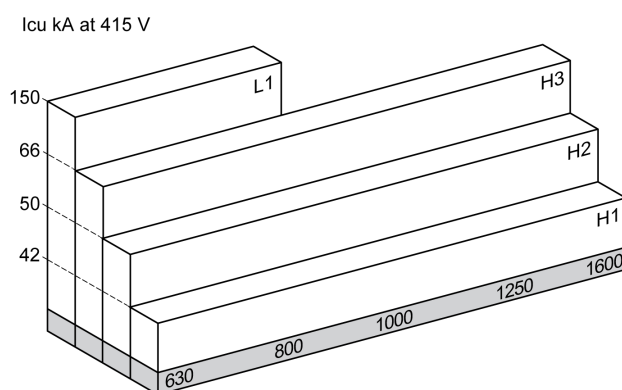

Circuit breakers are fitted with a MicroLogic X control unit.

For full information about available circuit breaker models, interrupting ratings, sensor ratings, and control units, refer to LVPED216026EN *MasterPact MTZ Catalogue*.

Switch-Disconnectors

The switch-disconnector functions in the HA performance level (I_{cw} = 36 kA/1s).

For information about available switch-disconnector models, refer to
LVPED216026EN *MasterPact MTZ Catalogue*.

Neutral Position on 4P Devices

On 4P devices, the neutral is on the left side as standard. A right side neutral version is not available for circuit breakers.

For switch-disconnectors, the user can change the neutral position to the right side.

A labelling kit is provided with the switch-disconnector.

Fixed Device

Fixed Device Description

The following image shows the standard version of the fixed device (no optional accessories).

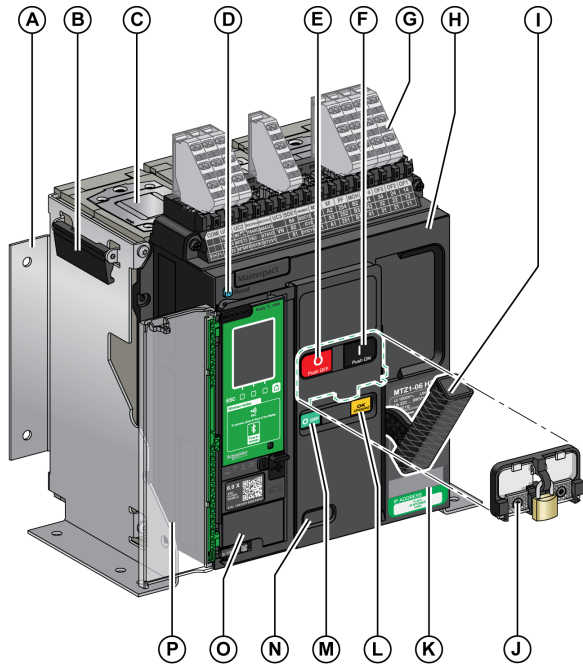

- A** Mounting side plate
- B** Carrying grip
- C** Arc chute
- D** Blue fault-trip reset button
- E** Opening pushbutton
- F** Closing pushbutton
- G** Terminal blocks for standard accessories
- H** Front cover
- I** Spring charging handle
- J** VBP pushbutton locking cover (optional)
- K** Rating plate
- L** Spring charged and ready-to-close indicator
- M** Main-contact position indicator
- N** Window to read the (optional) CDM mechanical operation counter
- O** Control unit
- P** Control unit transparent cover

Fixed Device Accessories Description

The following image shows the accessories available for the fixed device.

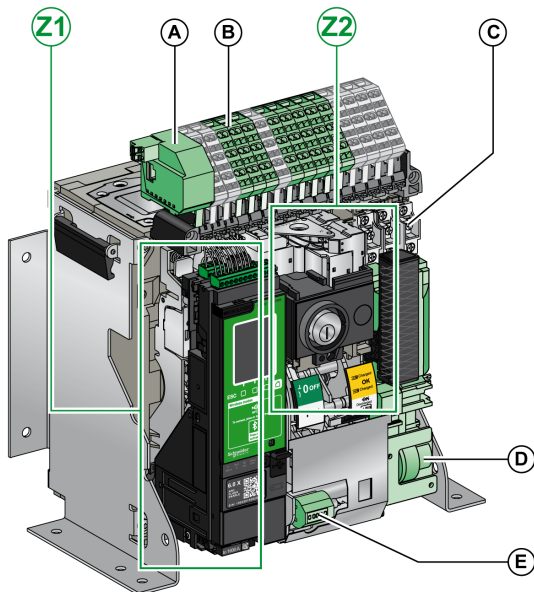

- A** ULP port module
- B** Terminal blocks for optional accessories
- C** Four OF indication contacts (delivered as standard)
- D** MCH gear motor
- E** CDM mechanical operation counter
- Z1, Z2** See following images

The following images zoom in on the accessories for the fixed device:

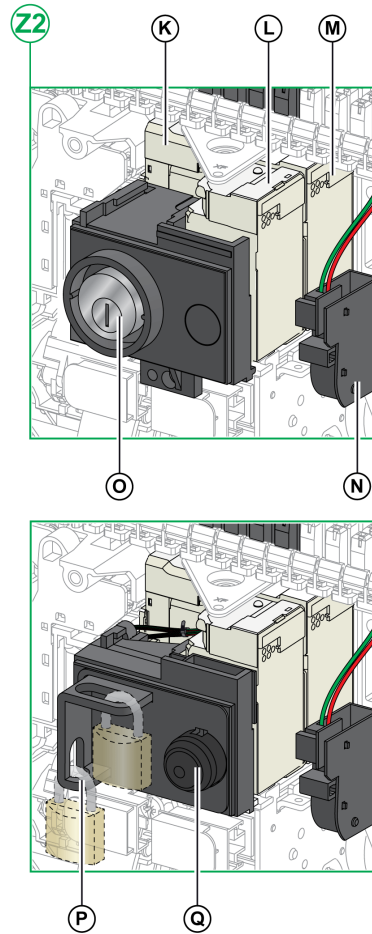
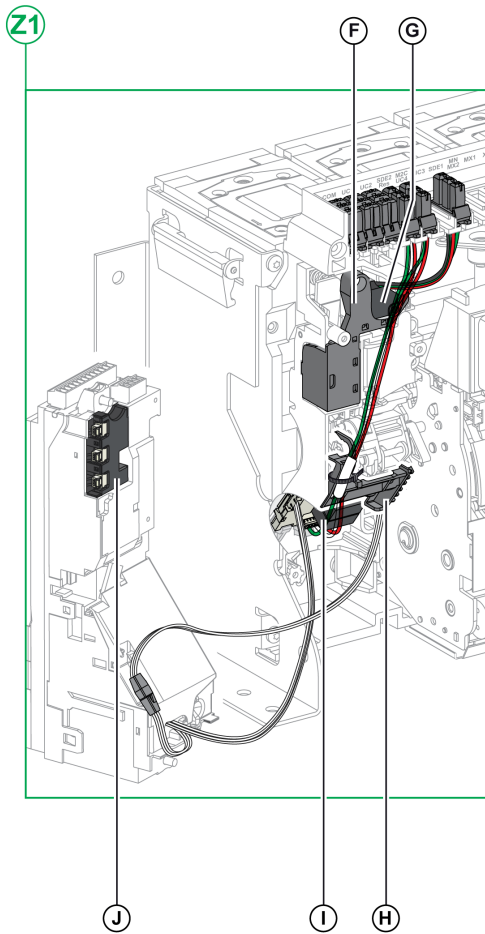

- F** Standard SDE1 fault-trip indication contact
- G** Optional SDE2 fault-trip indication contact or RES electrical remote reset
- H** Microswitch
- I** M2C programmable contacts or ESM ERMS switch module
- J** Isolation module

- K** MN undervoltage release or MX2 opening voltage release
- L** XF closing voltage release
- M** MX1 opening voltage release
- N** PF ready-to-close contact
- O** VSPO OFF-position locking by keylocks (incompatible with BPFE pushbutton)
- P** VCPO OFF-position locking by padlocks
- Q** BPFE electrical closing pushbutton

Fixed Device Terminal Block Description

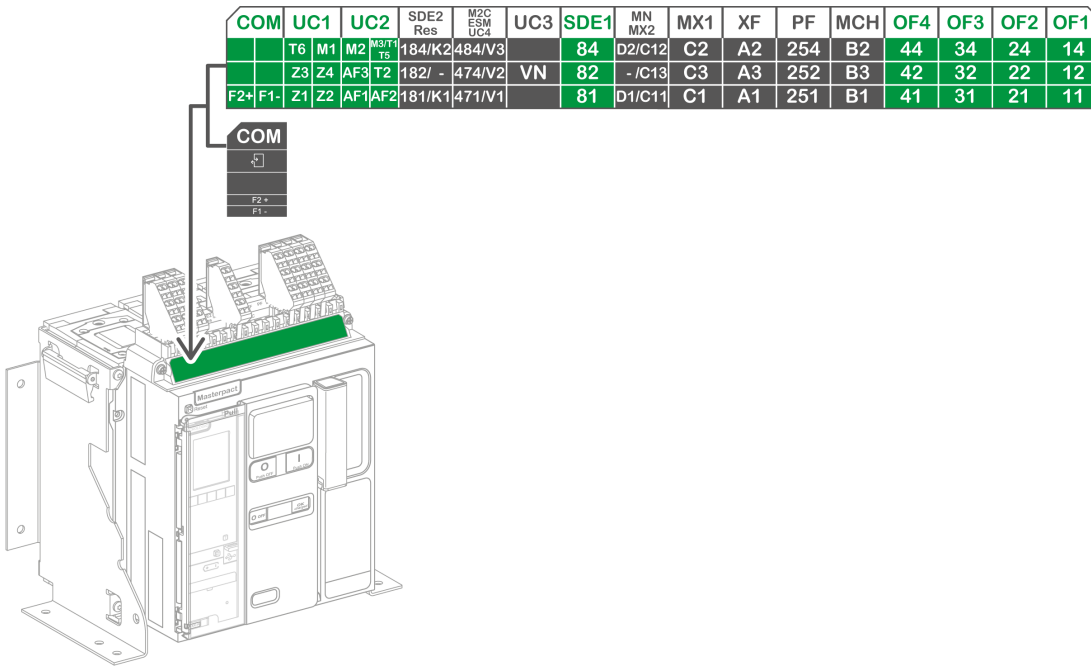

- Terminal block supplied as standard on the circuit breaker
- Terminal block for optional accessories on the circuit breaker

Assignment of Terminal Blocks

The following table describes the assignment and the availability of the terminal blocks for fixed circuit breakers and switch-disconnectors:

- Standard terminal blocks and the associated accessories are delivered with the device.
- Optional terminal blocks are delivered with the device only if the associated optional accessories are installed in the device.
- N/A indicates that the terminal blocks and the associated optional accessories are not compatible with the device.

Marking	Description	Circuit breaker	Switch-disconnector
COM	Terminal block for the external power supply of the MicroLogic X control unit or ULP port module	Standard Optional	N/A N/A
UC1	Zone selective interlocking (ZSI), rectangular sensor for earth-leakage protection, or MDGF module input	Standard	N/A
UC2	Neutral external sensor, rectangular sensor for earth-leakage protection, or MDGF module input	Standard	N/A
SDE2/RES	SDE2 additional fault-trip indication contact or RES electrical remote reset	Optional	N/A
M2C/ESM/UC4	M2C programmable contacts, ESM ERMS switch module, or external voltage connector	Optional	N/A
UC3	External voltage connector	<ul style="list-style-type: none"> • Standard on 3P devices • Optional on 4P devices 	N/A
SDE1	SDE1 fault-trip indication contact	Standard	N/A
MN/MX2	MN undervoltage release or MX2 opening voltage release	Optional	Optional
MX1	MX1 opening voltage release	Optional	Optional

Marking	Description	Circuit breaker	Switch-disconnector
XF	XF closing voltage release	Optional	Optional
PF	PF ready-to-close contact	Optional	Optional
MCH	MCH gear motor	Optional	Optional
OF1-OF4	4 OF indication contacts	Standard	Standard

Drawout Device

Definition

A drawout device is composed of the moving part (also called the device) and the fixed part (or chassis).

Drawout Device Moving Part Description

The following image shows the standard version of the moving part of a drawout device (no optional accessories).

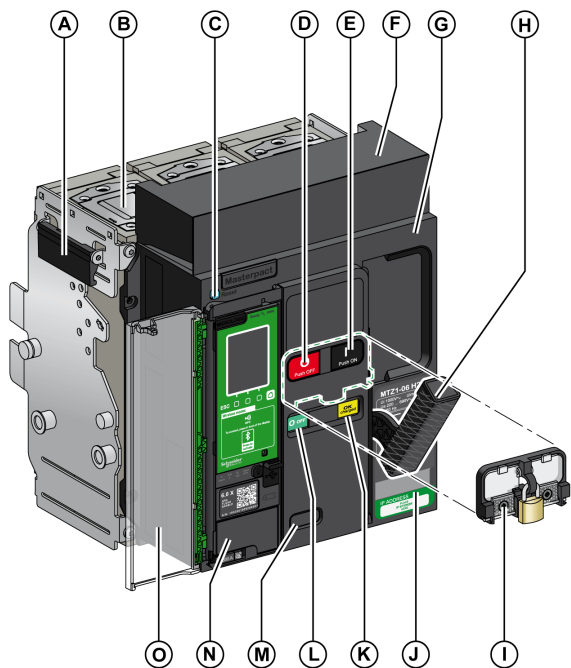

- A** Carrying grip
- B** Arc chute
- C** Blue fault-trip reset button
- D** Opening pushbutton
- E** Closing pushbutton
- F** Disconnectable contact block cover
- G** Front cover
- H** Spring charging handle
- I** VBP pushbutton locking cover (optional)
- J** Rating plate
- K** Spring charged and ready-to-close indicator
- L** Main-contact position indicator
- M** Window to consult the (optional) CDM mechanical operation counter
- N** Control unit
- O** Control unit transparent cover

Drawout Device Accessories Description

The following image shows the accessories available for the moving part of a drawout device.

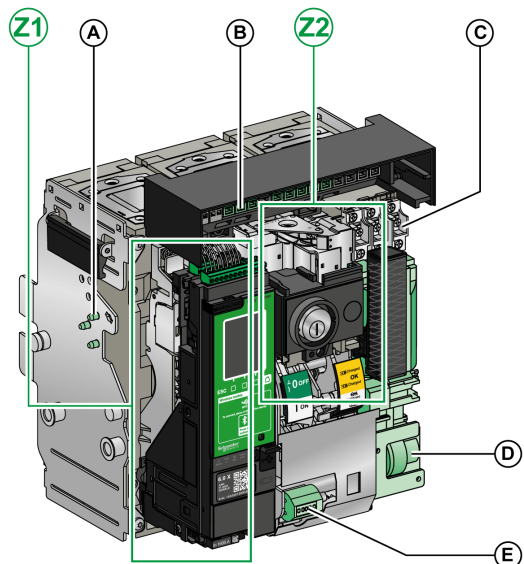

- A** VDC mismatch protection
- B** Disconnectable contact block
- C** Four OF indication contacts (delivered as standard)
- D** MCH gear motor
- E** CDM mechanical operation counter
- Z1, Z2** See following images

The following images zoom in on the accessories for the moving part of a drawout device.

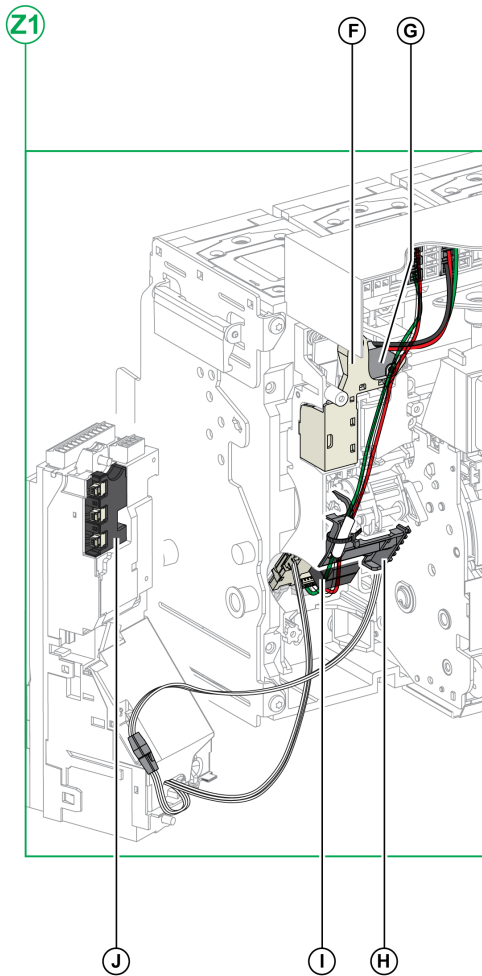

- F** Standard SDE1 fault-trip indication contact
- G** Optional SDE2 fault-trip indication contact or RES electrical remote reset
- H** Microswitch
- I** M2C programmable contacts or ESM ERMS switch module
- J** Isolation module

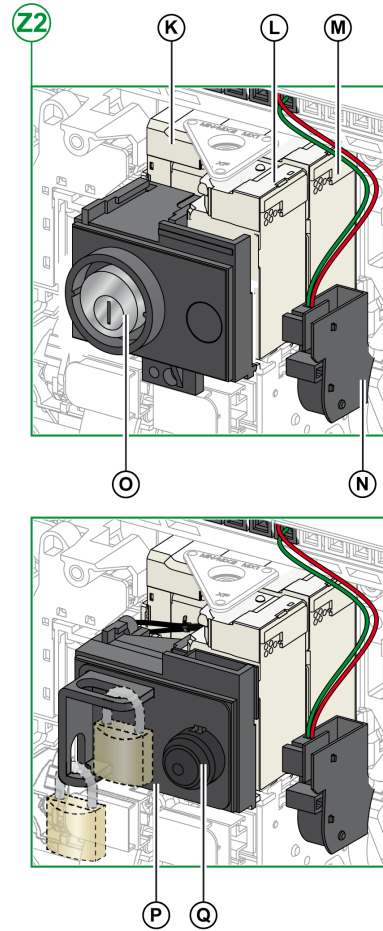

- K** MN undervoltage release or MX2 opening voltage release
- L** XF closing voltage release
- M** MX1 opening voltage release
- N** PF ready-to-close contact
- O** VSPO OFF-position locking by keylocks (incompatible with BPFE pushbutton)
- P** VCPO OFF-position locking by padlocks
- Q** BPFE electrical closing pushbutton

Chassis Description

The following image shows the standard version of the chassis (no optional accessories).

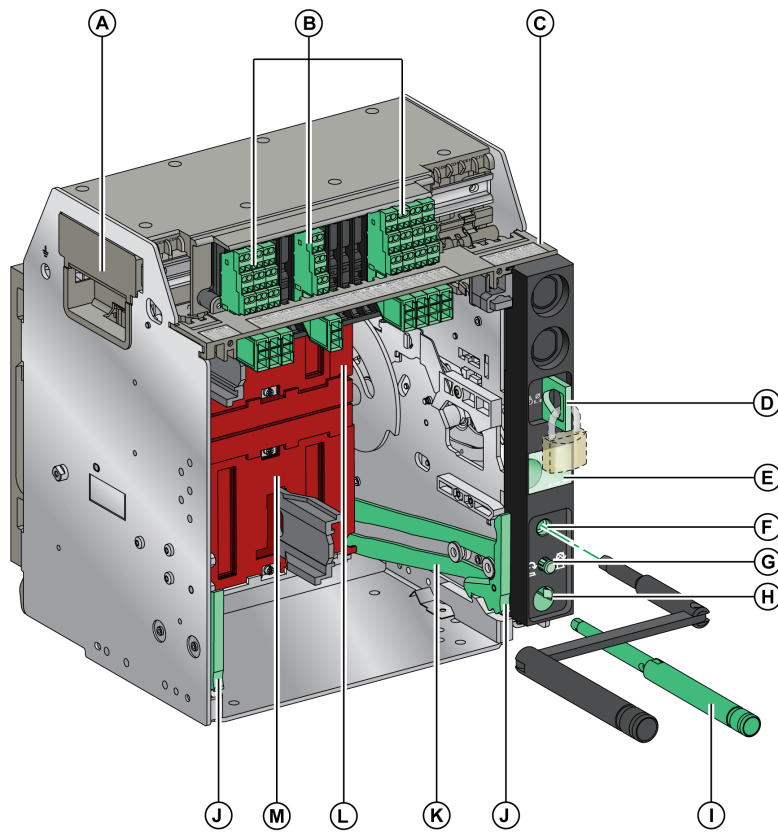

- A** Carrying grip
- B** Terminal blocks for standard accessories
- C** Terminal block identification plate
- D** Chassis locking by padlocks
- E** Moving part position indicator
- F** Racking handle socket
- G** Position release button
- H** Racking handle storage space
- I** Racking handle
- J** Drawout grip
- K** Extension rail
- L** Top safety shutter
- M** Bottom safety shutter

Chassis Accessories Description

The following image shows the accessories available for the chassis.

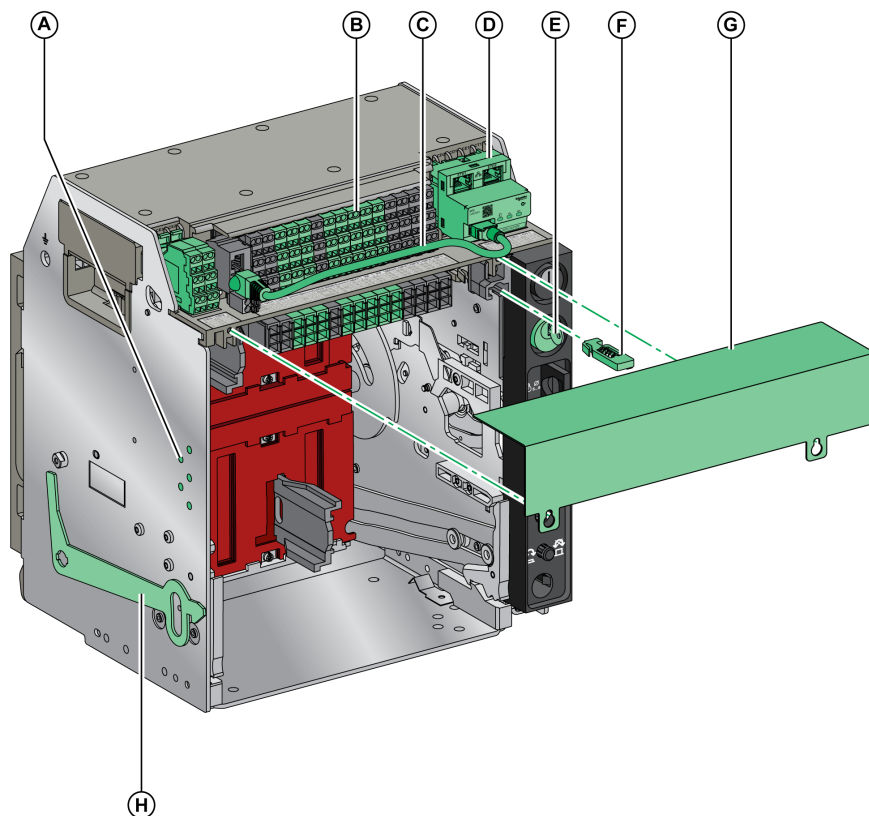

A VDC mismatch protection

B Terminal blocks for optional accessories

C Cord between ULP port module and EIFE interface

D EIFE embedded Ethernet interface

E VSPD chassis locking by keylocks

F VPOC open-door racking interlock

G Circuit breaker auxiliary terminal shield

H VPEC door interlock

Chassis Terminal Block Description

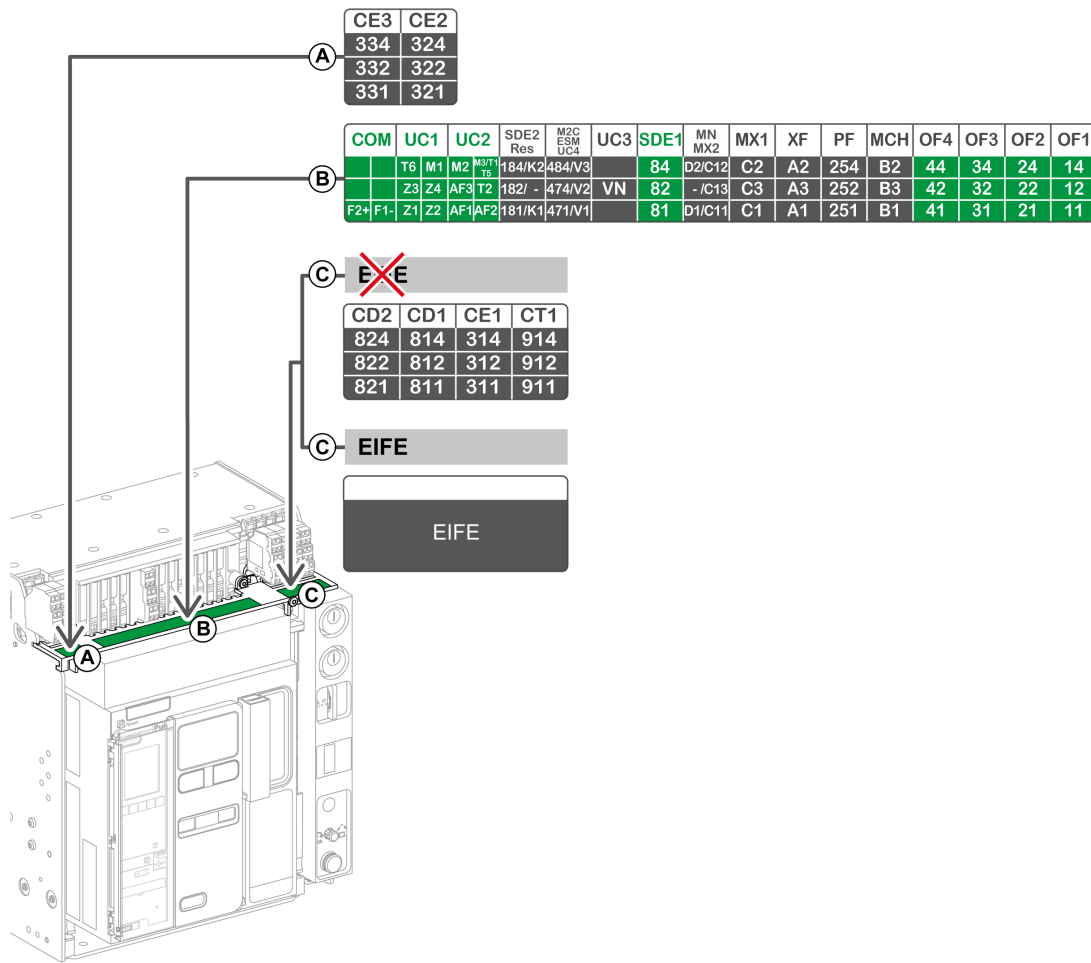

- Terminal block supplied as standard on the chassis
- Optional terminal block on the chassis

Assignment of Chassis Terminal Blocks

The following table describes the assignment and the availability of the terminal blocks for drawout circuit breakers and switch-disconnectors:

- Standard terminal blocks are delivered on the chassis, even if the associated accessories are not installed in the device.
- Optional terminal blocks are delivered on the chassis only if the associated optional accessories are installed in the device.
- N/A indicates that the terminal blocks and the associated optional accessories are not compatible with the device.

Block	Marking	Description	Circuit breaker	Switch-disconnector
A	CE2-CE3	2 CE connected position contacts	Optional	Optional
B	COM	Terminal block for the external power supply of the MicroLogic X control unit	Standard	N/A
		or ULP port module	Optional	N/A
	UC1	Zone selective interlocking (ZSI), rectangular sensor for earth-leakage protection, or MDGF module input	Standard	Standard
	UC2	Neutral external sensor, rectangular sensor for earth-leakage protection, or MDGF module input	Standard	Standard
	SDE2/RES	SDE2 additional fault-trip indication contact or RES electrical remote reset	Optional	N/A
	M2C/ESM/UC4	M2C programmable contact, ESM ERMS switch module, or external voltage connector	Optional	N/A
	UC3	External voltage connector	Standard on 3P circuit breaker Optional on 4P circuit breaker	N/A
	SDE1	SDE1 fault-trip indication contact	Standard	Standard
	MN/MX2	MN undervoltage release or MX2 opening voltage release	Standard	Standard
	MX1	MX1 opening voltage release	Standard	Standard
	XF	XF closing voltage release	Standard	Standard
	PF	PF ready-to-close contact	Standard	Standard
	MCH	MCH gear motor	Standard	Standard
OF1-OF4	4 OF indication contacts	Standard	Standard	
C (without EIFE interface)	CD1-CD2	2 CD disconnected position contacts	Optional	Optional
	CE1	1 CE connected position contact		
	CT1	1 CT test position contact		
C (with EIFE interface)	EIFE	EIFE embedded Ethernet interface	Optional	N/A

Device Identification

Identification

The MasterPact MTZ1 device can be identified in the following ways:

- Rating plate on device
- QR code located:
 - On the front face of the control unit of the circuit breaker
 - On the front face of the switch-disconnector
- Identification labels on the device and on the chassis

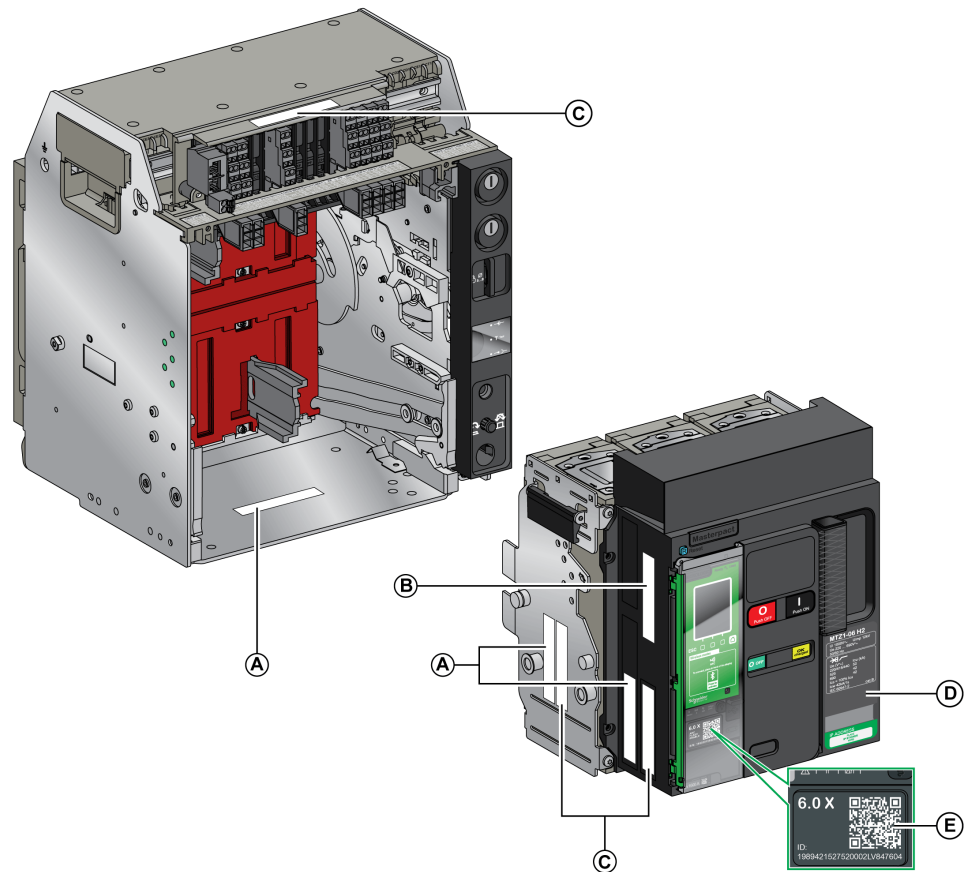

A Product identification label

B Product checked label

C Accessory voltages label

D Rating plate

E QR code to access product information

Product Identification Label

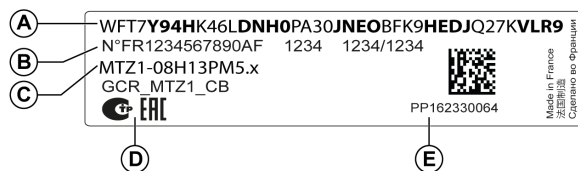

Legend	Description	Explanation
A	Product code	<p>The product code is a line of code representing the complete configuration of a MasterPact circuit breaker or switch-disconnector. It is automatically generated for each MasterPact device after completing the configuration by using the Product Selector configuration tool.</p> <p>The product code appears on the invoice and on the delivery documents as well as on the MasterPact device and packaging labels.</p> <p>The product code can be entered in the Product Selector configuration tool, which generates the complete configuration of the MasterPact device.</p>
B	Schneider Electric internal identification numbers	–
C	Description of device	<p>The description of the device, specifies the following characteristics:</p> <ul style="list-style-type: none"> • Range • Rating • Performance level • Number of poles • Control unit type
D	Certification logos	The logos of the mandatory certifications of the device.
E	Device serial number	<p>The device serial number is coded PPYYWWDXXXX, where:</p> <ul style="list-style-type: none"> • PP: Plant code • YY: Year of manufacture • WW: Week of manufacture • D: Day of the week of manufacture (Monday = 1) • XXXX: The production number of the device on the day. Ranges from 0001 to 9999. <p>For example, PP162330064 is the sixty-fourth device manufactured at plant PP on Wednesday, June 8, 2016.</p>

Product Checked Label



Legend	Description	Explanation
F	Device serial number	See explanation in preceding table.
G	Device test date code	<p>The device test date code is coded PPYYWWDD HH:MM, where:</p> <ul style="list-style-type: none"> • PP: Plant code • YY: Year of test • WW: Week of test • D: Day of the week of test (Monday = 1) • HH:MM: The time of test in hours and minutes

Accessory Voltages Label

Motormechanism MCH 200/240 VAC
 Voltage release MX 24/30 VDC
 Closing coil XF 48 VDC
 Undervoltage release MN 100/130 VDC
 Remote reset 200/240 VAC

The accessory voltages label gives the voltage of the accessories which are installed in the device and which need to be connected to a power supply.

Rating Plate

The rating plate with the device information is located on the front cover of the device.

Circuit breaker rating plate

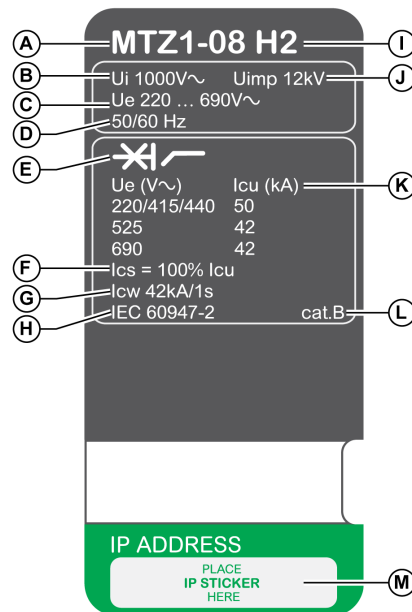

- A** Device size and rated current x 100 A
- B U_i**: rated insulation voltage
- C U_e**: rated operational voltage
- D** Frequency
- E** Type of device: circuit breaker or switch-disconnector, suitable for insulation
- F I_{cs}**: rated service short-circuit breaking capacity
- G I_{cw}**: rated short-time withstand current
- H** Standards
- I** Performance level

Switch-disconnector rating plate

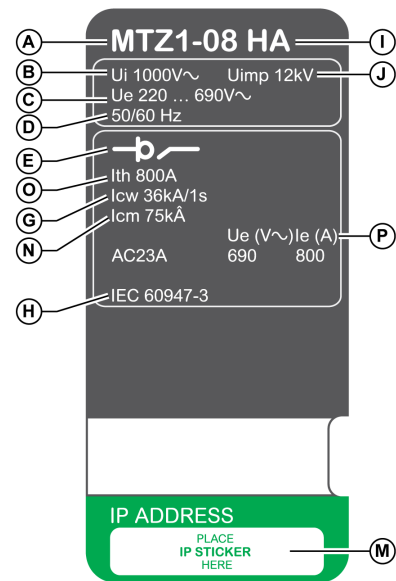

- J U_{imp}**: rated impulse withstand voltage
- K I_{cu}**: rated ultimate short-circuit breaking capacity
- L** Selectivity category as per IEC 60947-2
- M** Place for sticker with IP address of the optional EIFE interface
- N I_{cm}**: rated short-circuit making capacity
- O I_{th}**: conventional free air thermal current
- P I_e**: rated operational current

QR Code

When the QR code on the front face of a MasterPact MTZ device is scanned with a smartphone running a QR code reader and connected to the Internet, the Go2SE landing page is displayed, page 30. The landing page displays some information about the device and a list of menus.

MicroLogic X Control Unit: Description

Introduction

The MicroLogic X control unit includes:

- LEDs to monitor the status of the circuit breaker
- A local Human Machine Interface comprising a graphic display with colored backlight, contextual buttons, and dedicated buttons
- LEDs to monitor the cause of trips and alarms

Control Unit Description

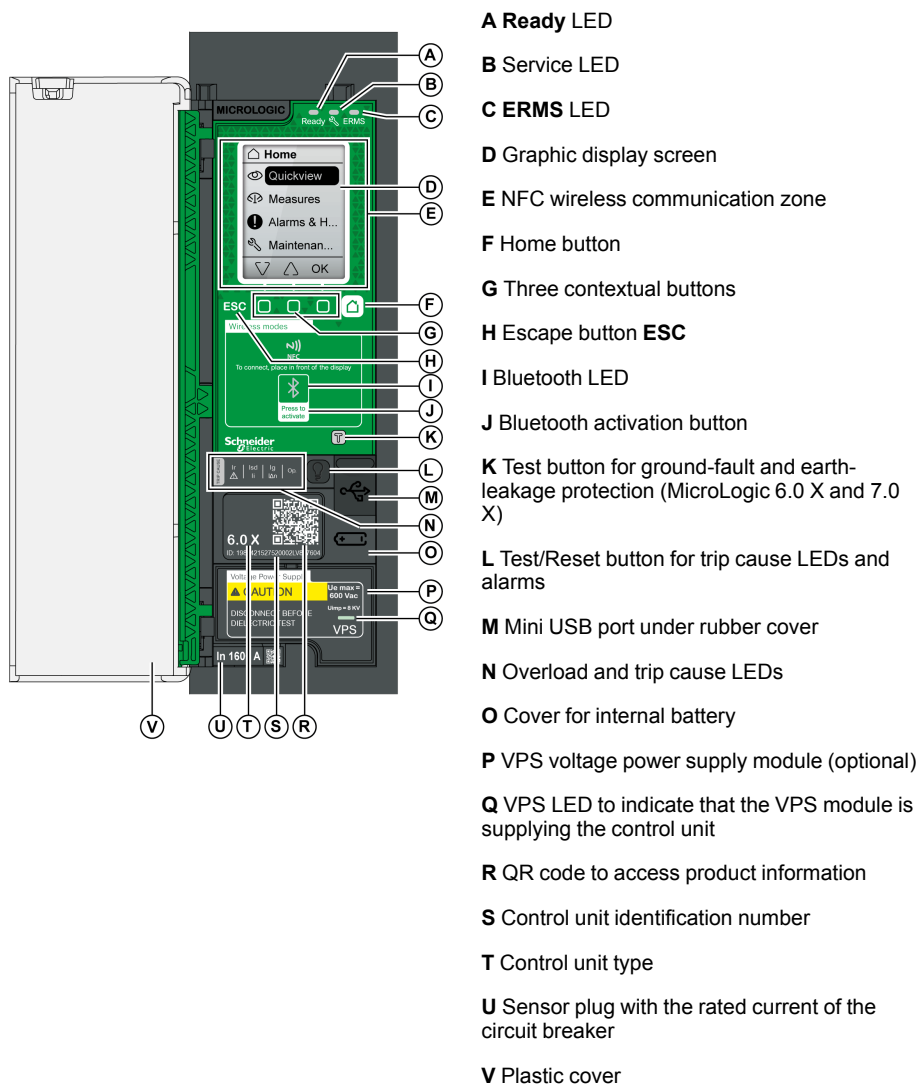

Status LEDs

LED	Description
Ready	The Ready LED blinks slowly when the standard protection functions of the control unit are operational.
	The service LED alerts the user to the health state of the circuit breaker. <ul style="list-style-type: none"> • Orange LED: medium severity detected alarm that requires non-urgent maintenance action. • Red LED: high severity detected alarm that requires immediate maintenance action.
ERMS	The ERMS (Energy Reduction Maintenance Setting) LED has the following statuses: <ul style="list-style-type: none"> • Blue LED: ERMS engaged • Off LED: ERMS disengaged

Display Screen with Contextual Buttons and Dedicated Buttons

The local HMI screen and buttons are used to:

- Navigate the menu structure.
- Display monitored values.
- Access and edit configuration settings.

NFC Communication Zone

The NFC communication zone is used to establish an NFC connection between a smartphone running the EcoStruxure Power Device app and the MicroLogic X control unit. When the connection is established, the circuit breaker operating data is automatically uploaded to the smartphone.

Bluetooth Activation Button and LED

The Bluetooth activation button is used to establish a Bluetooth low energy connection between a smartphone running the EcoStruxure Power Device app and the MicroLogic X control unit. When the connection is established, the circuit breaker can be monitored and controlled from the smartphone.







When the Bluetooth LED is blinking, it indicates that the MicroLogic X control unit is in communication with a Bluetooth device.

Test Button

The test button is used to test the ground-fault protection for MicroLogic 6.0 X and the earth-leakage protection for MicroLogic 7.0 X.

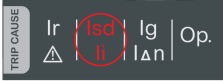
Overload and Trip Cause LEDs

The indications of the four trip cause LEDs depend on the type of MicroLogic X control unit.

LEDs	Description
	<ul style="list-style-type: none"> MicroLogic 2.0 X, 5.0 X, 6.0 X, 7.0 X: Overload pre-alarm, the load exceeds 90% and is lower than 105% of the Ir setting of the long-time protection.
	<ul style="list-style-type: none"> MicroLogic 2.0 X, 5.0 X, 6.0 X, 7.0 X: Overload alarm, the load exceeds 105% of the Ir setting of the long-time protection.
	<ul style="list-style-type: none"> MicroLogic 2.0 X, 5.0 X, 6.0 X, 7.0 X: Trip due to long-time protection.
	<ul style="list-style-type: none"> MicroLogic 2.0 X: Trip due to instantaneous protection. MicroLogic 5.0 X, 6.0 X, 7.0 X: Trip due to short-time protection or instantaneous protection.
	<ul style="list-style-type: none"> MicroLogic 2.0 X, 5.0 X: Not applicable. MicroLogic 6.0 X: Trip due to ground-fault protection. MicroLogic 7.0 X: Trip due to earth-leakage protection.
	<ul style="list-style-type: none"> MicroLogic 2.0 X, 5.0 X, 6.0 X, 7.0 X: Trip due to optional protections.
	<ul style="list-style-type: none"> MicroLogic 2.0 X, 5.0 X, 6.0 X, 7.0 X: MicroLogic control unit invalid result detected during self test.

NOTE: If the MicroLogic X control unit is not powered, the trip cause LEDs go off after 4 hours. After this period, press the Test/Reset button to light them again.

Test/Reset Button

The Test/Reset button performs the following functions:

- Test of the internal battery or check LED functionality: press and hold the Test/Reset button for less than 3 seconds, the four trip cause LEDs switch off for one second. One of the following results:
 - The four trip cause LEDs switch on for two seconds: the battery is OK.
 - The four trip cause LEDs flash sequentially for two seconds: the battery is near the end of its life. Replace the battery.
 - The four trip cause LEDs do not light: replace the battery.

NOTE: This test must be carried out immediately after the replacement of the internal battery to check the correct functioning of the new battery. It can then be carried out at any time in the life of the internal battery.
- Reset of the latched events: press and hold the Test/Reset button for more than 3 seconds to reset the latched events. The trip cause LEDs and the service LED switch off.

Mini USB Port

Remove the rubber cover of the mini USB port to connect the following devices:

- A Mobile Power Pack to supply power to the MicroLogic X control unit.
- A smartphone running the EcoStruxure Power Device app through USB OTG connection.
- A PC running EcoStruxure Power Commission software.

NOTE: The MicroLogic X control unit does not support USB keys. Even if a USB key is connected using an adapter, data is not transferred.

QR Code

When the QR code on the front face of a MicroLogic X control unit is scanned with a smartphone running a QR code reader and connected to the Internet, the Go2SE landing page is displayed, page 30. The landing page displays some information about the device and a list of menus.

Control Unit Identification Number

The identification number is made up as follows:

- The serial number of the MicroLogic X control unit in the format FFFFFFFYYWWDLXXXX
- The commercial reference of the control unit in the format LV8•••••

Use the identification number to register your MicroLogic X control unit through mySchneider app, the customer care mobile application.

Registering your MicroLogic X control unit enables you to keep your records up to date and enables traceability.

Control Unit Type

This code indicates the type of MicroLogic control unit:

- The number (for example, 6.0) defines the types of protection provided by the control unit.
- The letter (X) identifies the range of the control unit.

Internal Battery

The internal battery powers the trip cause LEDs and the main diagnostic functions in the absence of any other power supply.

VPS Voltage Power Supply Module

The VPS module provides an internal voltage supply to the MicroLogic X control unit.

The VPS module is optional for MicroLogic 2.0 X, 5.0 X, and 6.0 X. It is installed as standard on MicroLogic 7.0 X.

Sensor Plug

The protection ranges depend on the rated current I_n , defined by the sensor plug present below the MicroLogic X control unit.

Go2SE Landing Page

Presentation

When the QR code on the front face of a MasterPact MTZ device is scanned with a smartphone running a QR code reader and connected to the Internet, the Go2SE landing page is displayed.

The landing page displays information about the device and a list of menus.

Landing Page Description

The landing page is accessible from Android and iOS smartphones. It displays the same list of menus with slight differences in presentation.

The following example shows the landing page displayed on an Android smartphone:

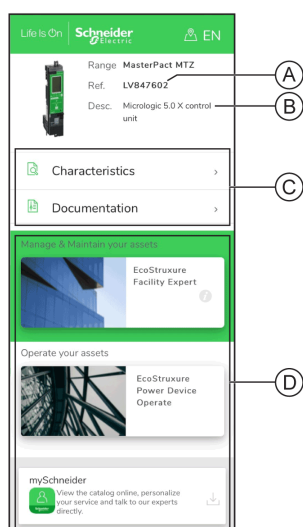

A Commercial reference of MicroLogic X control unit

B Type of MicroLogic X control unit

C Landing page menus. See the following menu descriptions for details.

D Downloadable applications

Characteristics

Selecting this menu gives access to a product datasheet with detailed information about the MicroLogic X control unit.

Documentation

Selecting this menu gives access to a sub-menu with the following options:

- **Asset Life Cycle Documents:** gives access to Safe Repository.
Safe Repository is a web service allowing documentation linked to assets to be consulted, stored, and shared in a Schneider Electric environment. Access to Safe Repository is restricted to authorized users.
Safe Repository gives access to the bill of materials of the MasterPact MTZ circuit breaker.

- **Technical Guidance at Glance:** gives access to the MasterPact MTZ technical publications, including:
 - *MasterPact MTZ - MicroLogic X Control Unit - User Guide*
 - *MasterPact MTZ1 - Circuit Breakers and Switch-Disconnectors - User Guide*
 - *MasterPact MTZ2/MTZ3 - Circuit Breakers and Switch-Disconnectors - User Guide*
 - All the instruction sheets for MasterPact MTZ devices and MicroLogic X control units
- **Product Documentation:** gives access to the MicroLogic X technical publications

EcoStruxure Facility Expert App

Selecting this application gives access to the EcoStruxure Facility Expert mobile application that can be downloaded on Android and iOS smartphones. For smartphone compatibility, check on your application store.

EcoStruxure Facility Expert optimizes operations and maintenance, helping to ensure business continuity, and provides insights to service providers or facility managers.

EcoStruxure Facility Expert is a real-time collaborative technology available on mobile devices and PCs that enables managers and maintenance personnel to be connected with facilities and equipment. Information exchange between users is simple and fast.

The QR code on MasterPact MTZ devices enables managers and maintenance personnel to access the following automatic downloads:

- MasterPact MTZ device identifier.
- Technical documentation.
- The maintenance plan for the MasterPact MTZ device.

EcoStruxure Facility Expert enables managers and maintenance personnel to access the maintenance plan for MasterPact MTZ devices.

EcoStruxure Facility Expert helps maintenance personnel to diagnose issues remotely and manage maintenance efficiently by:

- Providing relevant information on critical assets.
- Sending immediate state of the equipment and detailed information helping for diagnostics.

EcoStruxure Power Device App

Selecting this application gives access to the EcoStruxure Power Device app that can be downloaded and installed on Android and iOS smartphones. For smartphone compatibility, check on your application store.

mySchneider App

Selecting this application gives access to the Schneider Electric customer care mobile application **mySchneider** app that can be downloaded on Android and iOS smartphones. For smartphone compatibility, check on your application store. The customer care application offers self-service instructions and easy access to expert support and information.

Operating Conditions

Introduction

MasterPact MTZ devices are designed and tested for operation in industrial atmospheres. It is recommended that equipment is cooled or heated to the proper operating temperature and kept free of excessive vibration and dust.

Ambient Temperature

MasterPact MTZ devices can operate under the following temperature conditions:

- Electrical and mechanical characteristics specified for an ambient temperature of -25 °C to +70 °C.
- Circuit-breaker closing specified down to -35 °C by manual operation with closing pushbutton.

Storage conditions are as follows:

- -40 °C to +85 °C for the device without the control unit.
- -25 °C to +85 °C for the control unit.

Extreme Atmospheric Conditions

MasterPact MTZ devices have successfully passed tests for extreme atmospheric conditions, defined by the following standards:

Standard	Title
IEC 60068-2-1	Dry cold, at -40 °C
IEC 60068-2-2	Dry heat, at +85 °C
IEC 60068-2-30	Damp heat (temperature +55 °C, relative humidity 95%)
IEC 60068-2-52 level 2	Salt mist

Industrial Environments

MasterPact MTZ devices can operate in the industrial environments defined by IEC 60947 (pollution degree up to 3).

It is advisable to check that devices are installed in suitably cooled switchboards without excessive dust.

Conditions	Standard
Corrosive industrial atmospheres	Category 3C3 compliant with IEC 60721-3-3
Sea salts 0.8 to 8 mg/m ² day average over the year	Compliant with IEC 60721-2-5
Mechanically active substances	Category 3S3 compliant with IEC 60721-3-3

Beyond these conditions, MasterPact MTZ devices must be installed inside switchboards with an IP rating equal to or greater than IP54.

Vibration

MasterPact MTZ devices have successfully passed tests for the following vibration levels, in compliance with IEC 60068-2-6 and IEC 60068-2-27:

- 2 Hz to 13.2 Hz: amplitude +/- 1 mm.
- 13.2 Hz to 100 Hz: constant acceleration of 0.7 g.

Vibration testing to these levels is required by merchant marine inspection organizations (for example, Veritas, Lloyd's).

MasterPact MTZ devices have also been successfully tested according to:

- Annex Q - IEC 60947-1: Special tests – damp heat, salt mist, vibration and shock
- IEC 60947-1 - Category D: Environment subject to temperature, humidity and vibration

Altitude

MasterPact MTZ devices are designed and tested to operate at altitudes below 2,000 m.

At altitudes above 2,000 m, the characteristics of the ambient air (electrical resistance, cooling capacity) lower product characteristics as follows:

Characteristics		Altitude			
		2,000 m	3,000 m	4,000 m	5,000 m
Impulse withstand voltage Uimp (kV)		12	11	10	8
Rated insulation voltage (Ui) (V)		1,000	900	780	700
Maximum rated operational voltage 50/60 Hz Ue (V)	MasterPact MTZ1 except H3	690	690	630	560
	MasterPact MTZ1 H3	440	440	440	440
Rated current (A) at 40 °C		1 x In	0.99 x In	0.96 x In	0.94 x In

NOTE: Intermediate values can be obtained by interpolation.

Electromagnetic Disturbances

MasterPact MTZ devices have protection against:

- Overvoltages caused by devices that generate electromagnetic disturbance.
- Overvoltages caused by atmospheric disturbance or by a distribution-system outage (for example, a lighting system failure).
- Devices emitting radio waves (for example, radio transmitters, walkie-talkies, or radar).
- Electrostatic discharge produced by users.

MasterPact MTZ devices have successfully passed the electromagnetic-compatibility tests (EMC) defined by the following international standards:

- IEC 60947-2, appendix F.
- IEC 60947-2, appendix B (control units with earth-leakage function).

The devices have passed the above tests and therefore:

- No nuisance tripping occurs.
- Tripping times are respected.

MasterPact MTZ1 Normal Operation

What's in This Part

Device Operating Actions.....	35
Drawout Device Racking Actions.....	63
Device Locking Actions.....	77
Device Interlocking Actions.....	96

Device Operating Actions

What's in This Chapter

Operating the Device	36
Control Modes	40
Opening the Device	46
Closing the Device	49
Resetting the Circuit Breaker	52
Engaging the ERMS Function	53
Operating Accessories.....	56

Operating the Device

Device Status

The indicators on the front of the device show the following information:

- Reset button:
 - In: the device is closed or open voluntarily (not tripped)
 - Out: the device has tripped
- Position indicator of main contacts: ON or OFF.
- Closing spring and ready-to-close indicator. The state can be one of the following:
 - Discharged (no energy to close the circuit breaker)
 - Charged not ready-to-close
 - Charged ready-to-close

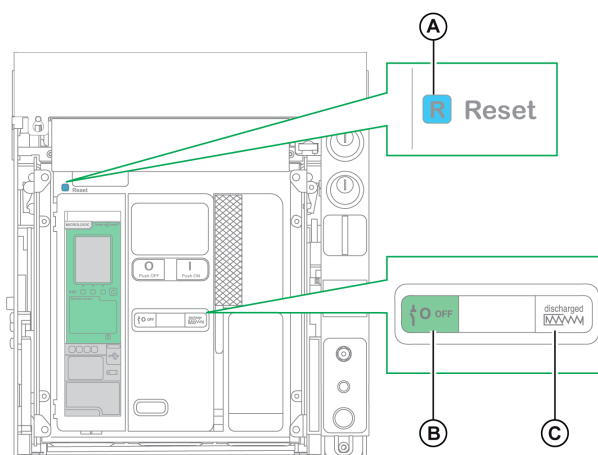





A Reset button

B Position indicator of main contacts

C Closing spring and ready-to-close indicator

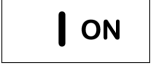

The combination of both indicators gives the device status:

Position indicator of main contacts	Closing spring and ready-to-close indicator	Device status description
		Device is off (main contacts are open) and closing spring is discharged.
		Device is off (main contacts are open) and closing spring is charged. The device is not ready-to-close because at least one of the following conditions is true: <ul style="list-style-type: none"> • The device has tripped and must be reset. • The MX opening voltage release is energized. • The MN undervoltage release is not energized. • The device is mechanically locked in the open position by using padlock or keylock or by using an interlocking system.
		Device is off (main contacts are open) and closing spring is charged. The device is ready-to-close.

Position indicator of main contacts	Closing spring and ready-to-close indicator	Device status description
		Device is on (main contacts are closed) and closing spring is discharged.
		Device is on (main contacts are closed) and closing spring is charged. The device is not ready-to-close because it is already closed.

Device Indication Contacts

The position of the device main contacts is indicated by OF indication contacts.

Name	Contact number	Position of indicators and contacts		
		ON	OFF	Tripped (by MicroLogic X control unit)
Device status	–	ON	OFF	Tripped (by MicroLogic X control unit)
Position indicator of main contacts	–			
Main contact position	–	Closed	Open	Open
Reset button position	–	IN	IN	OUT
OF indication contact position	1–2	Open	Closed	Closed
	1–4	Closed	Open	Open
SDE indication contact position	1–2	Closed	Closed	Open
	1–4	Open	Open	Closed

Anti-Pumping Function

MasterPact MTZ devices provide a mechanical anti-pumping function. In the event of simultaneous maintained opening and closing orders, the standard mechanism blocks the main contacts in the open position. After a trip due to an electrical fault or intentional opening using the manual or electrical controls, the closing order must first be discontinued, then reactivated to close the circuit breaker. This prevents a cycle of closing and opening.

When remote operation features are used, allow at least four seconds for the MCH gear motor to charge the device closing spring completely before the XF closing voltage release is actuated.

To prevent the device from closing prematurely, the PF ready-to-close contact can be series connected with the XF closing voltage release.

Charging the Closing Spring

The closing spring must be charged with sufficient energy to close the MasterPact MTZ:

- Manual charge: Charge the mechanism by pulling the spring charging handle down seven times.

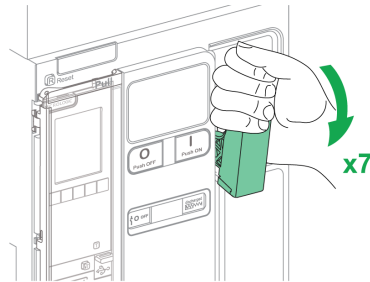

- Automatic charge: If the optional MCH gear motor is installed, the spring is automatically charged after closing.

Manual Operation Cycle with the Spring Charging Handle

The following image shows an Open/Close/Open (OCO) cycle for manually charged devices without MCH gear motor:

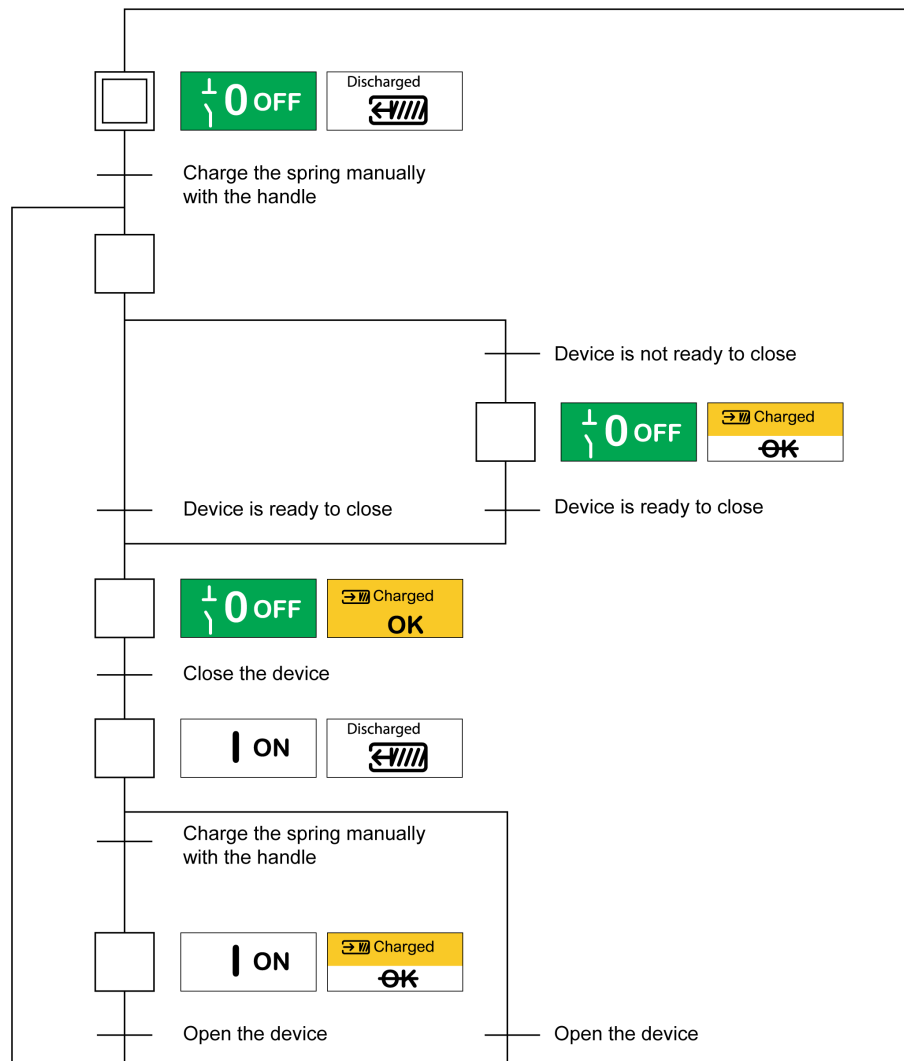

Electrical Operation Cycle with an MCH Gear Motor

The following image shows an Open/Close/Open (OCO) cycle for electrically charged devices using an MCH gear motor:

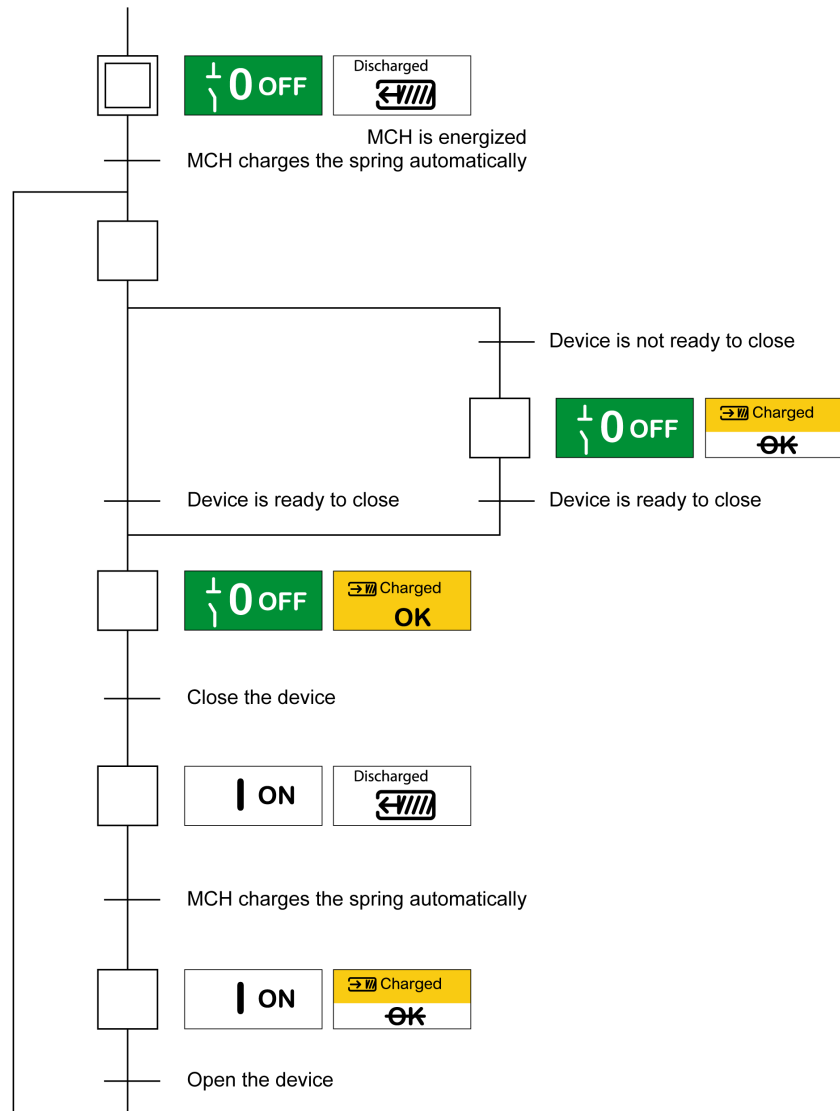

Control Modes

Presentation

The circuit breaker control mode is a MicroLogic X setting which defines the means to control the opening and closing functions of the circuit breaker.

Two control modes are available: Manual and Auto.

Manual control mode only accepts orders made using one of the following:

- The mechanical buttons on the front of the circuit breaker.
- The external pushbutton connected to the MN/MX/XF voltage releases.
- The BPF E electrical closing pushbutton.

Auto control mode has two settings: Local or Remote. All orders accepted in Manual control mode are accepted in Auto control mode, as well as orders from local or remote communication as follows:

- Auto Local: the operator needs to be close to the circuit breaker to establish communication and only orders sent from a local source through communication are accepted:
 - EcoStruxure Power Commission software through USB connection
 - EcoStruxure Power Device app with MasterPact Operation Assistant Digital Module through Bluetooth or USB OTG connection
- Auto Remote: the operator does not need to be next to the circuit breaker to establish communication and orders are accepted only when sent from a remote source through the communication network.

NOTE: EcoStruxure Power Commission software connected through the communication network can be used to send control orders to the circuit breaker.

The control mode factory setting is Auto Remote.

NOTE: The switch-disconnector control mode corresponds to the Manual control mode of circuit breakers. To operate a switch-disconnector through communication, it is possible to use an IO module. Refer to [DOCA0055EN Enerlin X IO – Input/Output Application Module for One IEC Circuit Breaker – User Guide](#).

Operation According to Control Mode Configured

The following table summarizes the opening and closing operations available, depending on the control mode configured:

Control mode	Type of order and delivery method									
	Mechanical	Electrical		Through communication						
	Pushbutton	BPF E	Point to point (voltage release)	IO module	FDM121 display	EcoStruxure Power Commission software ⁽¹⁾	EcoStruxure Power Device app + MasterPact Operation Assistant Digital Module ⁽²⁾	Communication network	FDM128 display	IFE/EIFE Weblogs
Manual	✓	✓	✓	–	–	–	–	–	–	–
Auto: Local	✓	✓	✓	✓ ⁽³⁾	✓	✓	✓	–	–	–
Auto: Remote	✓	✓	✓	✓ ⁽³⁾	–	–	–	✓	✓	✓
(1) Through USB										
(2) Through Bluetooth or USB OTG										
(3) According to IO input mode setting										

Operation in Manual Control Mode

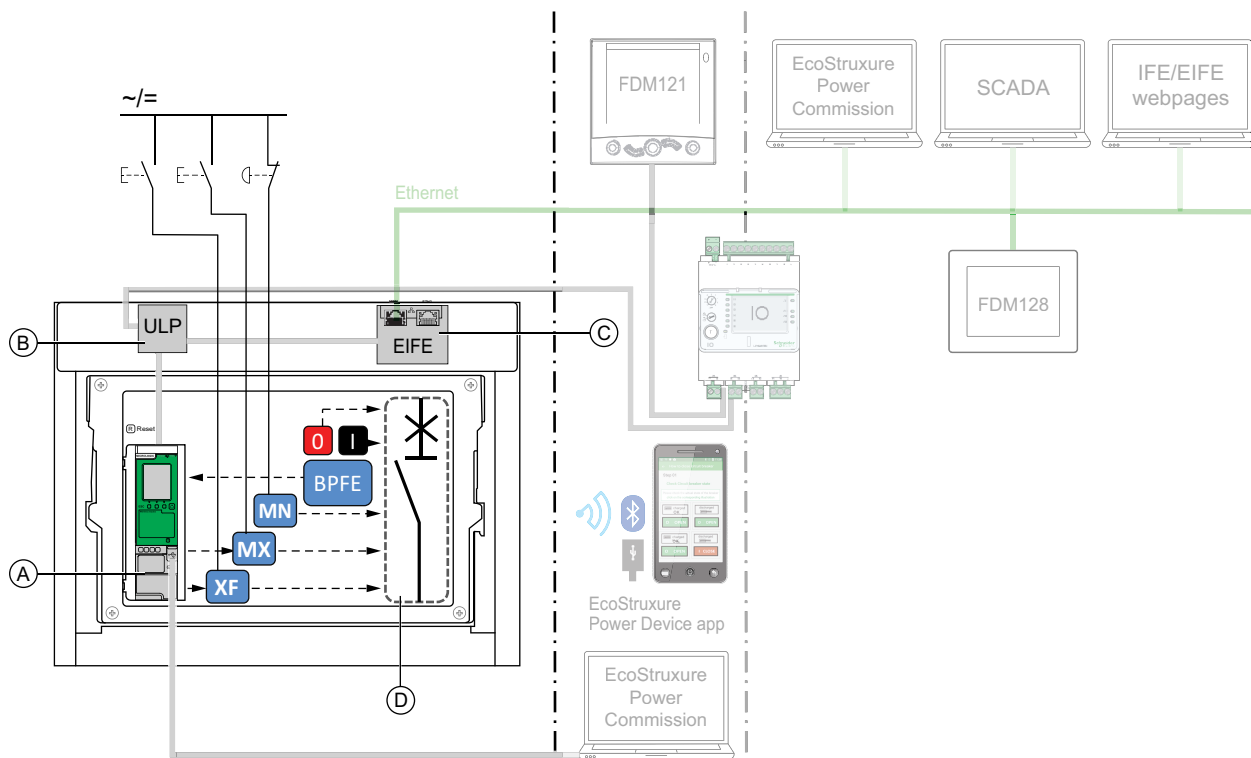

- A** MicroLogic X control unit
- B** ULP port module
- C** EIFE embedded Ethernet interface
- D** Circuit breaker mechanism

Opening and closing operations available in Manual control mode:

- 0: mechanical opening pushbutton
- 1: mechanical closing pushbutton
- BPFE: electrical closing pushbutton
- External pushbuttons wired by customer, and connected to:
 - XF: standard or communicating and diagnostic closing voltage release
 - MX: standard or communicating and diagnostic opening voltage release
 - MN: standard or diagnostic undervoltage release

Operation in Auto: Local Mode

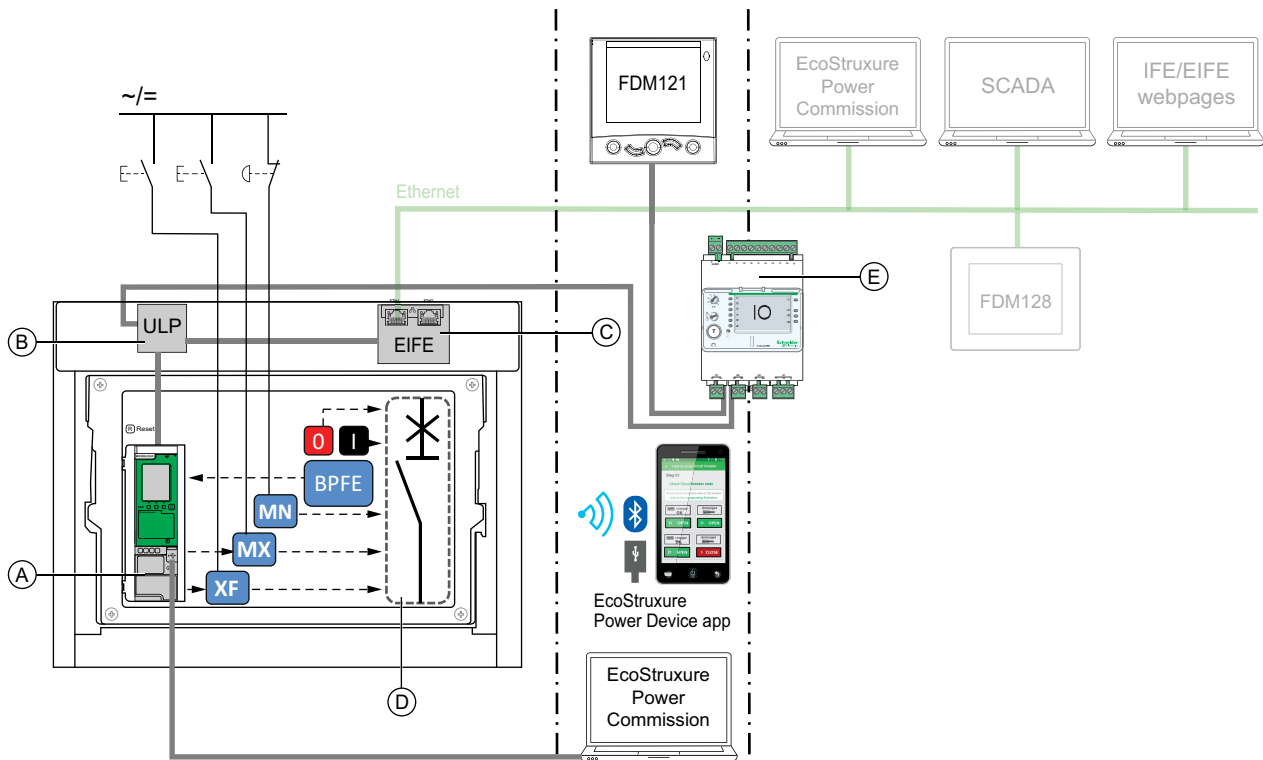

- A** MicroLogic X control unit
- B** ULP port module
- C** EIFE embedded Ethernet interface
- D** Circuit breaker mechanism
- E** IO input/output application module

Opening and closing operations available in Auto: Local mode:

- 0: mechanical opening pushbutton
- 1: mechanical closing pushbutton
- BPFE: electrical closing pushbutton
- External pushbuttons wired by customer, and connected to:
 - XF: communicating and diagnostic closing voltage release
 - MX: communicating and diagnostic opening voltage release
 - MN: standard or diagnostic undervoltage release
- IO: with the Breaker Operation predefined application of the IO module set to local control mode
- EcoStruxure Power Commission software: command sent through USB connection
- EcoStruxure Power Device app with MasterPact Operation Assistant Digital Module:
 - Through Bluetooth low energy wireless communication
 - Through USB OTG connection

Operation in Auto: Remote Mode

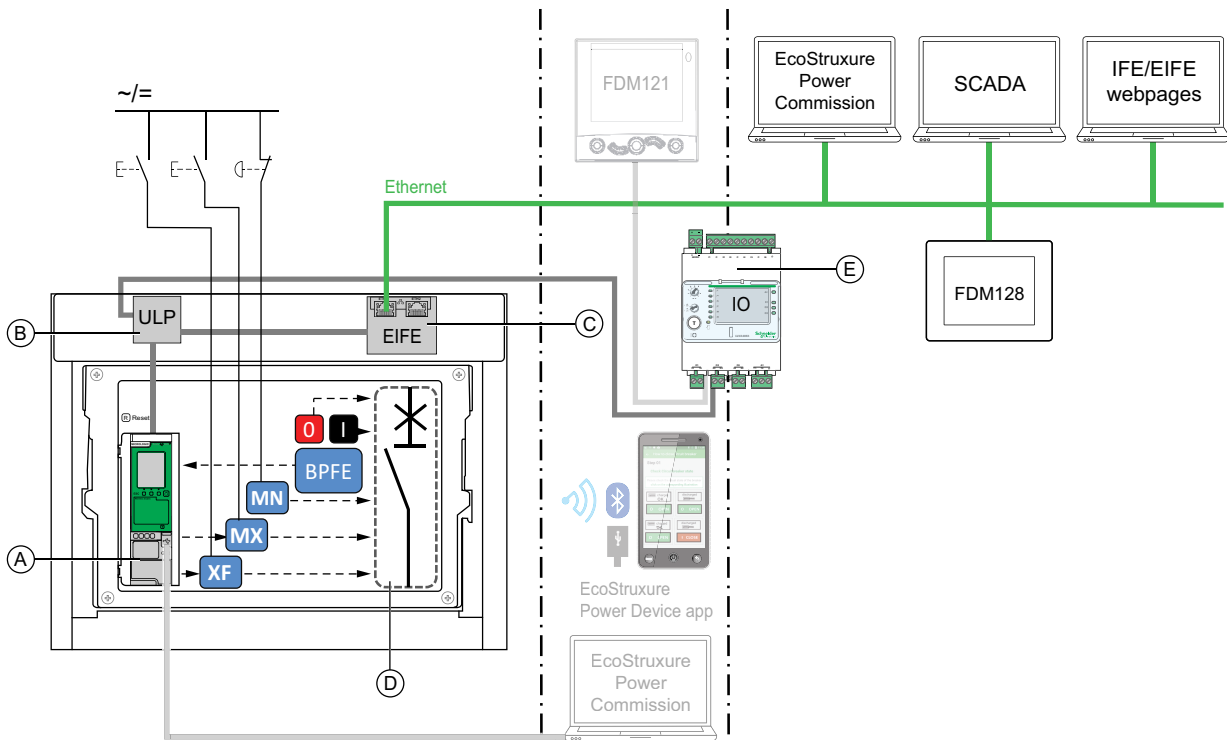

- A** MicroLogic X control unit
- B** ULP port module
- C** EIFE embedded Ethernet interface
- D** Circuit breaker mechanism
- E** IO input/output application module

Opening and closing operations available in Auto: Remote mode:

- 0: mechanical opening pushbutton
- 1: mechanical closing pushbutton
- BPF: electrical closing pushbutton
- External pushbuttons wired by customer, and connected to:
 - XF: communicating and diagnostic closing voltage release
 - MX: communicating and diagnostic opening voltage release
 - MN: standard or diagnostic undervoltage release
- IO: with the Breaker Operation predefined application of the IO module set to remote control mode
- Communication: remote command through IFE, EIFE, or IFM interface.

Setting the Control Mode

The Auto or Manual control mode can be set as follows:

- On the MicroLogic X display screen, at **Home > Configuration > Communication > Control Mode > Mode**.
- With the EcoStruxure Power Device app through Bluetooth or USB OTG connection.

The Local or Remote mode can be set as follows:

- When the IO module is used with the Breaker Operation predefined application, the local or remote mode is defined only by the control mode selector switch wired on the digital input I1 of the IO module.
- When the IO module is not used with the Breaker Operation predefined application, the local or remote mode can be set as follows:
 - With EcoStruxure Power Commission software through USB connection.
 - With the EcoStruxure Power Device app through Bluetooth or USB OTG connection.
 - With the FDM121 display connected to the MicroLogic X control unit through the ULP system.

NOTE:

- The Local or Remote mode cannot be set on the MicroLogic X display screen.
- When Auto control mode is set, the control mode is Auto Local or Auto Remote, depending on the last setting.

Displaying the Control Mode

The control mode (Manual, Auto Local, or Auto Remote) is displayed as follows:

- On the MicroLogic X display screen, at **Home > Configuration > Communication > Control Mode > Mode**
- With EcoStruxure Power Commission software through USB connection
- With the EcoStruxure Power Device app through Bluetooth or USB OTG connection
- On the IFE/EIFE webpages
- By a remote controller using the communication network.

Predefined Events

Changing the control mode settings generates the following events:

Code	Event	History	Severity
0x1002 (4098)	Manual mode enabled	Operation	Low
0x1004 (4100)	Local mode enabled	Operation	Low
0x0D0D (3341)	Config. error IO and CU - Local/Remote mode	Configuration	Medium

Recommended Actions

Code	Event	Recommended actions
0x0D0D (3341)	Config. error IO and CU - Local/Remote mode	Correct the configuration error with EcoStruxure Power Commission: <ul style="list-style-type: none">• If you want the L/R mode to be controlled by the IO module, connect an IO module with L/R mode assignment.• If you do not want the L/R mode to be controlled by the IO module, connect an IO module without L/R mode assignment.

Opening the Device

Opening Conditions

To open the device, the device must be closed (I).

NOTE: An opening order always takes priority over a closing order.

Opening the Device

The following tables present the different ways to open the device in the different control modes available.

The device can be opened in the following ways in **all** control modes:

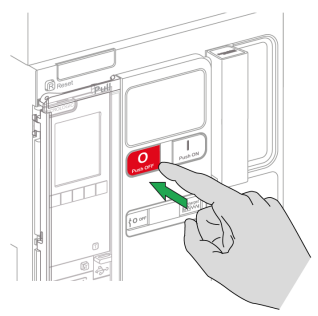
Opening type	Control mode	Accessories	Opening action
Mechanical	Manual, Auto: Local, or Auto: Remote	–	<p>Press the opening pushbutton on the front of the device.</p> <p>This opening action is possible at any time.</p> 
Automatic	Manual, Auto: Local, or Auto: Remote	MN undervoltage release, with or without MN delay unit	The MN undervoltage release opens the device automatically in the case of voltage drop.
By external pushbutton	Manual, Auto: Local, or Auto: Remote	<ul style="list-style-type: none"> • External pushbutton wired by customer • One of the following accessories: <ul style="list-style-type: none"> ◦ MX standard or communicating opening voltage release ◦ MN undervoltage release, with or without MN delay unit 	<p>Press the external pushbutton which is connected to the MX opening voltage release or to the MN undervoltage release via the customer terminal block.</p> <p>When the MN undervoltage release is connected to the MN delay unit, the device opens with the corresponding time delay.</p>

In addition, the circuit breaker can be opened in the following ways when **Auto** control mode is configured.

⚡ ⚠ DANGER

HAZARD OF ELECTRIC SHOCK, EXPLOSION, OR ARC FLASH

- Do not operate the circuit breaker without confirming that doing so will not create a hazardous situation.
- Do not allow any person to work on the electrical network without physically validating the successful execution of the local or remote software actions for opening the circuit breaker or switching off the electrical circuit.

Failure to follow these instructions will result in death or serious injury.

Opening type	Control mode	Accessories	Opening action
Through IO module	Auto: Local or Auto: Remote	<ul style="list-style-type: none"> • MX communicating opening voltage release • Isolation module • ULP port module • IO module 	<p>Open the circuit breaker by using the predefined application 2 Breaker Operation of the IO module.</p> <ul style="list-style-type: none"> • When the circuit breaker is set to local control mode by the IO module, the command to open is issued from local pushbuttons wired on digital inputs. • When the circuit breaker is set to remote control mode by the IO module, the command to open is issued from remote PLC outputs wired on digital inputs. <p>Refer to <i>DOCA0055EN Enerlin'X IO – Input/Output Application Module for One IEC Circuit Breaker – User Guide</i>.</p>
Through FDM121 display	Auto: Local	<ul style="list-style-type: none"> • MX communicating opening voltage release • Isolation module 	<p>Send a command to open the circuit breaker from FDM121 display connected locally to the device through the ULP bus.</p> <p>The opening action is password-protected.</p>
Through EcoStruxure Power Commission software	Auto: Local	<ul style="list-style-type: none"> • MX communicating opening voltage release • Isolation module 	<p>Send a command to open the circuit breaker from EcoStruxure Power Commission software running on a PC connected locally to the device through the mini USB port on the MicroLogic X control unit.</p> <p>This opening action is password-protected.</p> <p>Refer to <i>EcoStruxure Power Commission Online Help</i>.</p>
Through EcoStruxure Power Device app	Auto: Local	<ul style="list-style-type: none"> • MX communicating opening voltage release • Isolation module • MasterPact Operation Assistant Digital Module 	<p>Send a command to open the circuit breaker from the EcoStruxure Power Device app with MasterPact Operation Assistant Digital Module, through Bluetooth wireless communication or USB OTG connection. The opening action is password-protected.</p>
Through Modbus communication	Auto: Remote	<ul style="list-style-type: none"> • MX communicating opening voltage release • Isolation module • ULP port module • IFE, EIFE, or IFM interface, or IFE server 	<p>Send a command to open the circuit breaker through the Modbus communication network.</p> <p>This opening action is password-protected.</p> <p>Refer to <i>DOCA0105EN MasterPact MTZ – Modbus Communication – User Guide</i>.</p> <p>NOTE: EcoStruxure Power Commission software running on a PC connected to the device through the communication network can be used to send commands to open.</p>

Opening type	Control mode	Accessories	Opening action
Through IEC 61850 communication	Auto: Remote	<ul style="list-style-type: none"> • MX communicating opening voltage release • Isolation module • ULP port module • IFE or EIFE interface • IEC 61850 for MasterPact MTZ Digital Module 	<p>Send a command to open the circuit breaker through the IEC 61850 communication network.</p> <p>This opening action is password-protected.</p> <p>Refer to <i>DOCA0162EN MasterPact MTZ - IEC 61850 Communication Guide</i>.</p>
Through IFE/EIFE webpages	Auto: Remote	<ul style="list-style-type: none"> • MX communicating opening voltage release • Isolation module • ULP port module • IFE or EIFE interface, or IFE server 	<p>Send a command to open the circuit breaker from the IFE/EIFE control webpage.</p> <p>This opening action is password-protected.</p> <p>Refer to the relevant document:</p> <ul style="list-style-type: none"> • <i>DOCA0084EN Enerlin'X IFE – Ethernet Switchboard Server – User Guide</i> • <i>DOCA0142EN Enerlin'X IFE - Ethernet Interface for One IEC Circuit Breaker – User Guide</i> • <i>DOCA0106EN Enerlin'X EIFE – Embedded Ethernet Interface for One MasterPact MTZ Drawout Circuit Breaker – User Guide</i>

If the device does not open, refer to the troubleshooting chapter, page 142.

Closing the Device

Closing Conditions

To close the device, the following conditions must be met:

- Device is open (O).
- Closing spring is charged.
- The device is ready to close, **OK** is displayed.

NOTE: An opening order always takes priority over a closing order. The device cannot be closed while an opening order is being received. If **OK** is crossed-out on the ready-to-close indicator, an order to open is being received (either electrically or mechanically) and must be ended before **OK** can be displayed.

⚠️ ⚠️ DANGER

HAZARD OF ELECTRIC SHOCK, EXPLOSION, OR ARC FLASH

Do not re-close the device on an electrical fault. First inspect and, if necessary, repair the downstream equipment.

Failure to follow these instructions will result in death or serious injury.

Closing the Device

The following tables present the different ways to close the device in the different control modes available.

The device can be closed in the following ways in **all** control modes:

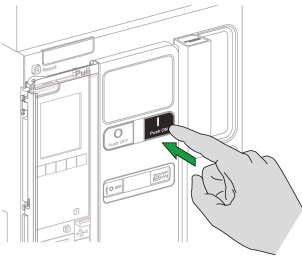
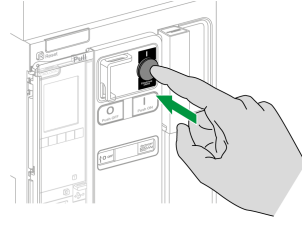
Closing type	Control mode	Accessories	Closing action
Mechanical	Manual, Auto: Local, or Auto: Remote	–	<p>Press the closing pushbutton on the front of the device.</p> <p>The closing action is possible when the closing conditions are met.</p> 
Electrical with BPFE	Manual, Auto: Local, or Auto: Remote	<ul style="list-style-type: none"> • BPFE electrical closing pushbutton • XF communicating closing voltage release • Isolation module 	<p>Press the BPFE electrical closing pushbutton, mounted on the front cover.</p> <p>The closing action takes into account internal closing conditions of the device and the external conditions that are part of the control and monitoring system of the installation.</p> 
External pushbutton	Manual, Auto: Local, or Auto: Remote	<ul style="list-style-type: none"> • External pushbutton wired by customer • XF standard or communicating closing voltage release • Isolation module • MCH gear motor 	<p>Press the external pushbutton, which is connected to the XF closing voltage release through the customer terminal block.</p>

In addition, the circuit breaker can be closed in the following ways when **Auto** control mode is configured.

⚡ ⚠ DANGER

HAZARD OF ELECTRIC SHOCK, EXPLOSION, OR ARC FLASH

- Do not operate the circuit breaker without confirming that doing so will not create a hazardous situation.
- Do not allow any person to work on the electrical network without physically validating the successful execution of the local or remote software actions for closing the circuit breaker or switching on the electrical circuit.

Failure to follow these instructions will result in death or serious injury.

Closing type	Control mode	Accessories	Closing action
Through IO module	Auto: Local or Auto: Remote	<ul style="list-style-type: none"> • XF communicating closing voltage release • Isolation module • MCH gear motor • ULP port module • IO module 	<p>Close the circuit breaker by using the predefined application 2 Breaker Operation of the IO module:</p> <ul style="list-style-type: none"> • When the circuit breaker is set to local control mode by the IO module, the command to close is issued from local pushbuttons wired on digital inputs. • When the circuit breaker is set to remote control mode by the IO module, the command to close is issued from remote PLC outputs wired on digital inputs. <p>Refer to <i>DOCA0055EN Enerlin'X IO – Input/Output Application Module for One IEC Circuit Breaker – User Guide</i>.</p>
Through FDM121 display	Auto: Local	<ul style="list-style-type: none"> • XF communicating closing voltage release • Isolation module • MCH gear motor 	<p>Send a command to close the circuit breaker from FDM121 display connected locally to the device through the ULP bus.</p> <p>The closing action is password-protected.</p>
Through EcoStruxure Power Commission software	Auto: Local	<ul style="list-style-type: none"> • XF communicating closing voltage release • Isolation module • MCH gear motor 	<p>Send a command to close the circuit breaker from EcoStruxure Power Commission software running on a PC connected locally to the circuit breaker through the mini USB port on the MicroLogic X control unit.</p> <p>The closing action is password-protected.</p> <p>Refer to <i>EcoStruxure Power Commission Online Help</i>.</p>
Through EcoStruxure Power Device app	Auto: Local	<ul style="list-style-type: none"> • XF communicating closing voltage release • Isolation module • MCH gear motor • MasterPact Operation Assistant Digital Module 	<p>Send a command to close the circuit breaker from the EcoStruxure Power Device app with MasterPact Operation Assistant Digital Module, through Bluetooth wireless communication or USB OTG connection.</p> <p>The closing action is password-protected.</p>
Through Modbus communication	Auto: Remote	<ul style="list-style-type: none"> • XF communicating closing voltage release • Isolation module • MCH gear motor • ULP port module • IFE, EIFE, or IFM interface, or IFE server 	<p>Send a command to close the circuit breaker through the Modbus communication network.</p> <p>The closing action is password-protected.</p> <p>Refer to <i>DOCA0105EN MasterPact MTZ – Modbus Communication – User Guide</i>.</p> <p>NOTE: EcoStruxure Power Commission software running on a PC connected to the circuit breaker through the communication network can be used to send commands to close.</p>

Closing type	Control mode	Accessories	Closing action
Through IEC 61850 communication	Auto: Remote	<ul style="list-style-type: none"> • XF communicating closing voltage release • Isolation module • MCH gear motor • ULP port module • IFE or EIFE interface • IEC 61850 for MasterPact MTZ Digital Module 	<p>Send a command to close the circuit breaker through the IEC 61850 communication network.</p> <p>This closing action is password-protected.</p> <p>Refer to <i>DOCA0162EN MasterPact MTZ - IEC 61850 Communication Guide</i>.</p>
Through IFE/EIFE webpages	Auto: Remote	<ul style="list-style-type: none"> • XF communicating closing voltage release • Isolation module • MCH gear motor • ULP port module • IFE or EIFE interface, or IFE server 	<p>Send a command to close the circuit breaker from the IFE/EIFE control webpage.</p> <p>The closing action is password-protected.</p> <p>Refer to the relevant document:</p> <ul style="list-style-type: none"> • <i>DOCA0084EN Enerlin'X IFE – Ethernet Switchboard Server – User Guide</i> • <i>DOCA0142EN Enerlin'X IFE - Ethernet Interface for One IEC Circuit Breaker – User Guide</i> • <i>DOCA0106EN Enerlin'X EIFE – Embedded Ethernet Interface for One MasterPact MTZ Drawout Circuit Breaker – User Guide</i>

If the device does not close, refer to the troubleshooting chapter, page 142.

Inhibiting the Closing Function

The closing function can be inhibited by sending a command through:

- The communication network or EcoStruxure Power Commission software
- The IO module

NOTE: Using EcoStruxure Power Commission software, you can determine whether the closing inhibition can be controlled using the IO module. For more information, refer to *EcoStruxure Power Commission Online Help*.

⚠ WARNING
<p>RESTRICTED CLOSING INHIBITION</p> <p>Do not use the inhibit closing order to lock the circuit breaker in open position.</p> <p>Failure to follow these instructions can result in death, serious injury, or equipment damage.</p>

The inhibit close order inhibits only the closing orders allowed in Auto control mode. The closing orders issued from the mechanical closing pushbutton or BPFE, or from the pushbutton directly connected to the XF voltage release are not inhibited.

Resetting the Circuit Breaker

Resetting Conditions

After a trip, the circuit breaker must be reset before closing it.

Resetting is possible in all control modes.

Resetting the Circuit Breaker

The circuit breaker can be reset in different ways, according to the circuit breaker configuration and its accessories:

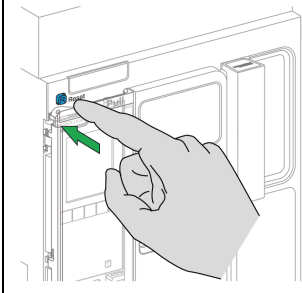
Type of resetting	Accessories	Resetting action
Mechanical with the blue fault-trip reset button	–	<p>Push in the blue fault-trip reset button on the front of the circuit breaker. This resetting action is always possible. Pushing in the blue fault-trip reset button resets the SDE fault-trip indication contact, and allows the circuit breaker to be closed.</p> 
Automatic (RAR automatic reset option)	<ul style="list-style-type: none"> • XF communicating or standard closing voltage release • Isolation module • MCH gear motor 	<p>After a trip, RAR automatic reset allows the circuit breaker to be closed without the blue fault-trip reset button being pushed in. The use of XF closing voltage release is compulsory with this option.</p> <p>The mechanical indicator and the SDE fault-trip indication contact remain in detected fault position.</p> <p>To reset the SDE fault-trip indication contact and the mechanical indicator, push in the blue fault-trip reset button.</p>
Electrical with external pushbutton	<ul style="list-style-type: none"> • External pushbutton wired by customer • RES electrical remote reset • XF communicating or standard closing voltage release • Isolation module • MCH gear motor 	<p>Press the external pushbutton which is connected to the RES electrical remote reset via the customer terminal block.</p> <p>The use of XF closing voltage release is compulsory with this option.</p> <p>The RES electrical remote reset resets the SDE fault-trip indication contact and the mechanical indicator, and allows the circuit breaker to be closed.</p> <p>NOTE: The RES electrical remote reset is not compatible with the SDE2 option.</p>

Engaging the ERMS Function

Presentation

Engage the ERMS function to reduce protection settings so that the circuit breaker trips as soon as possible when an internal arc fault occurs. Minimizing the time between fault and trip helps to reduce the risk of injury when qualified electrical personnel are near energized equipment.

Conditions for Engaging the ERMS Function

The ERMS function is available when the Energy Reduction Maintenance Settings Digital Module is purchased and installed on the MicroLogic X control unit.

Operating Principle

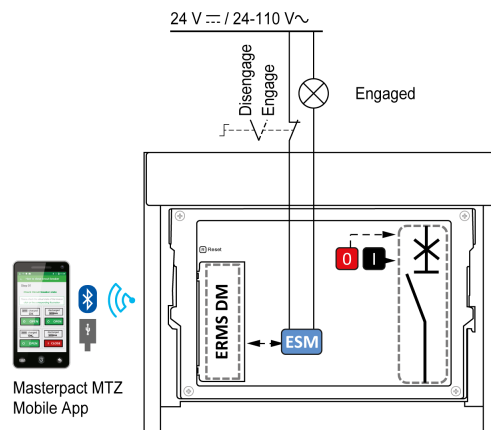

The ERMS function can be engaged as follows:

- With the EcoStruxure Power Device app (password-protected).
There is a digital lock between a smartphone running the EcoStruxure Power Device app and the MicroLogic X control unit.
- By using an external selector switch connected to the optional ESM ERMS switch module.

The ESM module is installed in the circuit breaker and is connected to an external selector switch, which can be padlocked. The ERMS function is engaged by turning the external selector switch.

The ERMS function can be engaged with both the EcoStruxure Power Device app (password-protected) and an external selector switch.

The ERMS function must be disengaged by the interface that engaged it:

- If it is engaged on a smartphone, it must be disengaged by the same smartphone.
- If it is engaged by the external ERMS switch connected to the ESM module, it must be disengaged by the ERMS switch.
- If it is engaged by both smartphone and ERMS switch, it must be disengaged by both smartphone and ERMS switch.

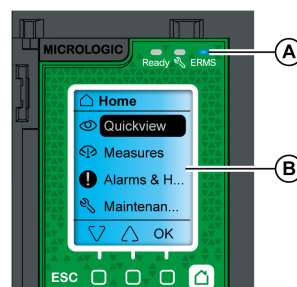

While the ERMS function is engaged:

- A blue ERMS LED (A) is lit on the front face of the MicroLogic X control unit
- Quick View scrolling is interrupted and the **ERMS engaged** message is displayed with a blue backlight
- All screens, except pop-up messages, are displayed with a blue backlight

For more information, refer to DOCA0102EN *MasterPact MTZ – MicroLogic X Control Unit – User Guide*.

Engaging the ERMS Function

NOTICE		
HAZARD OF LOSS OF POWER		
Ensure that the ERMS protection settings are properly configured prior to engagement.		
Failure to follow these instructions can result in loss of service due to power loss.		

The ERMS can be engaged in different ways, according to the circuit breaker configuration and its accessories:

Type	Accessories	Action
Through EcoStruxure Power Device app	–	Send a command from the EcoStruxure Power Device app to engage the ERMS function, through Bluetooth wireless communication or USB OTG connection. The action is password-protected.
Through an external selector switch connected to the ESM module	<ul style="list-style-type: none"> ESM ERMS switch module External selector switch 	Turn the external selector switch to the Engaged position

Disengaging the ERMS Function

 DANGER		
HAZARD OF ELECTRIC SHOCK, EXPLOSION, OR ARC FLASH		
Prior to disengaging ERMS:		
<ul style="list-style-type: none"> Carefully inspect your work area, and remove any tools and objects left inside the equipment. Ensure that all personnel are away from the equipment, and devices, doors, and covers are in place. 		
Failure to follow these instructions will result in death or serious injury.		

A digital lock function establishes a digital lock between a smartphone running the EcoStruxure Power Device app and the MicroLogic X control unit when ERMS is engaged by the smartphone. The digital lock function ensures that when the ERMS function is engaged by a smartphone, it must be disengaged by the same smartphone.

The way to disengage the ERMS function depends on how it was engaged:

Type	Accessories	Action
Through EcoStruxure Power Device app	–	Disengage the ERMS function on the same smartphone that engaged it
Through an external selector switch	<ul style="list-style-type: none"> ESM ERMS switch module External selector switch 	Turn the external selector switch to the Disengaged position
Through EcoStruxure Power Device app and an external selector switch	<ul style="list-style-type: none"> ESM ERMS switch module External selector switch 	<ul style="list-style-type: none"> Disengage the ERMS function on the same smartphone that engaged it Turn the external selector switch to the Disengaged position

Operating Accessories

XF, MX, and MN Voltage Releases

XF, MX, and MN voltage releases are optional accessories mounted inside the device. They can be of standard type or diagnostic and communicating type (standard or with diagnostic function for MN undervoltage release).

The standard voltage releases are designed to receive either pulse-type or maintained voltage operating orders.

XF Closing Voltage Release (Standard or With Diagnostic and Communicating Function)

The XF closing voltage release closes the circuit breaker instantaneously when powered if the spring mechanism is charged. The minimum duration of the pulse operating order must be 200 ms.

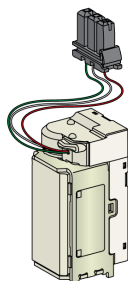

For information on installation, consult the instruction sheet on the Schneider Electric website:

- XF standard closing voltage release: NVE40749
- XF communicating closing voltage release: NVE40766

MX Opening Voltage Release (Standard or With Diagnostic and Communicating Function)

The MX opening voltage release opens the circuit breaker instantaneously when powered. The minimum duration of the pulse operating order must be 200 ms. The MX standard opening voltage release locks the circuit breaker in OFF position if the command is maintained.

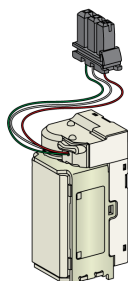

For information on installation, consult the instruction sheet on the Schneider Electric website:

- MX standard opening voltage release: NVE40749
- MX communicating opening voltage release: NVE40766

MN Undervoltage Release (Standard or With Diagnostic Function)

The MN undervoltage release instantaneously opens the circuit breaker when its supply voltage drops to a value between 35% and 70% of its rated voltage. If there is no supply to the release, it is impossible to close the circuit breaker, either manually or electrically. Any attempt to close the circuit breaker has no effect on the main contacts. Circuit breaker closing is enabled again when the supply voltage of the release returns to 85% of its rated value.

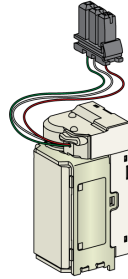

For information on installation, consult the instruction sheet on the Schneider Electric website:

- MN standard undervoltage release: NVE40749
- MN undervoltage release with diagnostic function: NVE40766

Isolation Module for Communicating Voltage Releases

The internal isolation module for MicroLogic X control units provides double insulation in compliance with IEC 60664-1 (up to 12 kV). It also provides insulation between the XF, MX, and MN types of voltage release.

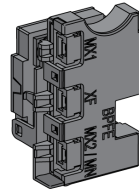

For information on installation, consult the instruction sheet on the Schneider Electric website: NVE40748.

BPFE Electrical Closing Pushbutton

This is an optional accessory that is mounted on the front cover of the device.

The BPFE electrical closing pushbutton carries out electrical closing of the circuit breaker. It takes into account the internal closing conditions of the device and the external conditions that are part of the control and monitoring system of the installation. It connects to the XF standard or communicating closing voltage release.

If BPFE is being used, it is recommended to lock access to the closing pushbutton using the VBP accessory because the closing pushbutton does not take into account internal and external conditions.

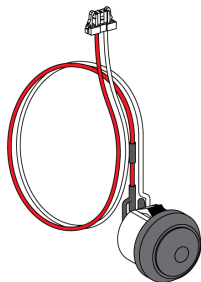

For information on installation, consult the instruction sheet on the Schneider Electric website: [NVE40771](#).

PF Ready-to-close Contact

This is an optional accessory that is mounted inside the device.

The PF ready-to-close contact delivers remotely, the indication delivered locally by the ready-to-close indicator.

It consists of a changeover contact indicating remotely that the circuit breaker is ready to close, that is:

- The circuit breaker is in the open position.
- The spring mechanism is charged.
- There is no maintained opening order.

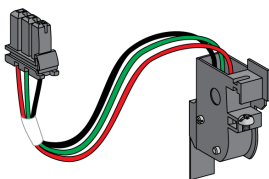

For information on installation, consult the instruction sheet on the Schneider Electric website: [NVE35466](#).

MCH Gear Motor

This is an optional accessory that is mounted inside the device.

The MCH gear motor automatically charges the spring mechanism when the device is closed, allowing instantaneous closing of the device following opening.

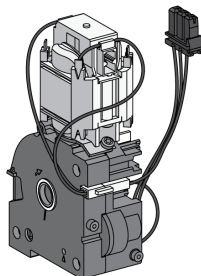

For information on installation, consult the instruction sheet on the Schneider Electric website: [NVE35514](#).

RES Electrical Remote Reset

This is an optional accessory that is mounted inside the device.

Following tripping, this function resets the SDE fault-trip indication contact, and the mechanical indicator and enables circuit breaker closing.

The use of an XF closing release is compulsory with this option.

The RES electrical remote reset is not compatible with the SDE2 additional fault-trip indication contact because they are installed in the same physical place.

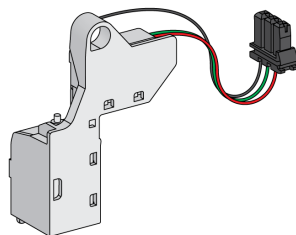

ESM ERMS Switch Module

This is an optional accessory that is mounted inside the device.

The ESM ERMS switch module is used to engage ERMS protection settings. The ESM module works in conjunction with the ERMS Digital Module, which must also be installed.

The ESM ERMS switch module is not compatible with M2C programmable contacts because they are installed in the same physical place.

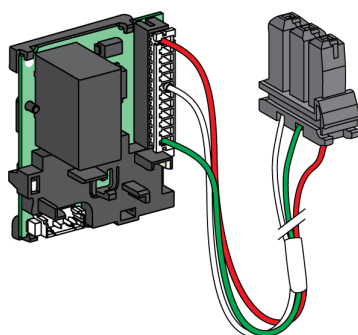

For installation of the ESM ERMS switch module, contact your Schneider Electric field service representative.

CDM Mechanical Operation Counter

This is an optional accessory that is mounted inside the device.

The CDM mechanical operation counter counts the number of operating cycles and is visible on the front panel. It is compatible with manual and electrical control functions.

This option is compulsory for all source-changeover systems.

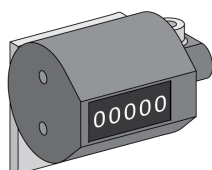

For information on installation, consult the instruction sheet on the Schneider Electric website: NVE35516.

ULP Port Module

The ULP port module is an optional accessory that is mounted with the terminal blocks of the device.

The ULP port module:

- Supplies the MicroLogic X control unit.
- Integrates the ULP termination.
- Allows the connection to external ULP modules, like the IO module or the IFE Ethernet interface.

Fixed circuit breaker:

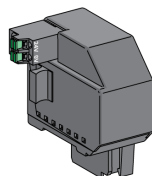

Drawout circuit breaker:

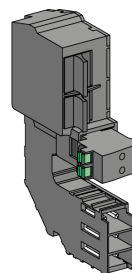

For information on installation, consult the instruction sheet on the Schneider Electric website:

- ULP port module for fixed MasterPact MTZ1: NVE40791
- ULP port module for drawout MasterPact MTZ1: NVE40796

EIFE Embedded Ethernet Interface

This is an optional accessory that is mounted on the chassis of the drawout circuit breaker.

The EIFE embedded Ethernet interface enables drawout MasterPact MTZ circuit breakers to be connected to an Ethernet network with the following protocols:

- Modbus TCP/IP
- IEC 61850 with addition of the IEC 61850 for MasterPact MTZ Digital Module

It provides digital access to all the data delivered by the MicroLogic X control unit. In addition, it monitors the position of the device in the chassis: connected, test, and disconnected.

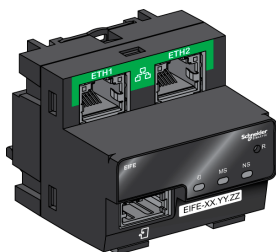

For information on installation, consult the instruction sheet on the Schneider Electric website: NVE23550.

For information on usage, refer to DOCA0106EN *Enerlin'X EIFE – Embedded Ethernet Interface for One MasterPact MTZ Drawout Circuit Breaker – User Guide*.

IFE Ethernet Interface for One Circuit Breaker

The IFE Ethernet interface provides an Ethernet access to a single circuit breaker with the following protocols:

- Modbus TCP/IP
- IEC 61850 with addition of the IEC 61850 for MasterPact MTZ Digital Module

The circuit breaker is connected to the IFE interface through the ULP port module and a prefabricated ULP cord.

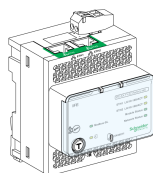

For information on installation, consult the instruction sheet on the Schneider Electric website: HRB49218.

For information on usage, refer to DOCA0142EN *Enerlin'X IFE - Ethernet Interface for One IEC Circuit Breaker – User Guide*.

IFE Ethernet Switchboard Server

The IFE Ethernet switchboard server provides an Ethernet access to one or several circuit breakers with the Modbus TCP/IP protocol. It allows the following communication architectures:

- One single circuit breaker connected to the IFE server through the ULP port module.
- Up to 11 circuit breakers through IFM Modbus-SL interfaces stacked to the IFE server.

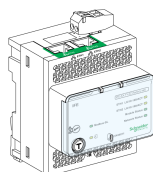

For information on installation, consult the instruction sheet on the Schneider Electric website: HRB49218.

For information on usage, refer to DOCA0084EN *Enerlin'X IFE – Ethernet Switchboard Server – User Guide*.

IFM Modbus-SL Interface for One Circuit Breaker

The IFM Modbus-SL interface provides an access to a Modbus serial line communication network to a single device. The device is connected to the IFM interface through the ULP port module and a prefabricated ULP cord.



For information on installation, consult the instruction sheet on the Schneider Electric website: NVE85393.

IO Input/Output Application Module for One Circuit Breaker

The IO input/output application module for one circuit breaker is one of the components of the ULP architecture.

The IO application module enhances control and monitoring functions, thanks to its built-in applications. Its resources are:

- Six digital inputs that are self-powered for either NO and NC dry contact or pulse counter.
- Three digital outputs that are bistable relay (5 A maximum).
- One analog input for Pt100 temperature sensor.

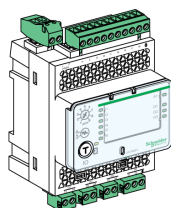

For information on installation, consult the instruction sheet on the Schneider Electric website: HRB49217.

For information on usage, refer to DOCA0055EN *Enerlin'X IO – Input/Output Application Module for One IEC Circuit Breaker – User Guide*.

FDM121 Front Display Module for One Circuit Breaker

The FDM121 front display module for one circuit breaker shows the measurements, alarms, and operating assistance data from a single intelligent modular unit with a Compact or Masterpact circuit breaker.

The FDM121 display with firmware version 004.000.009 or greater is compatible with MicroLogic X control units. Earlier firmware versions need to be updated.

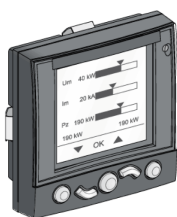

For information on installation, consult the instruction sheet on the Schneider Electric website: QGH80971.

For information on usage, refer to DOCA0088EN *Enerlin'X FDM121 – Front Display Module for One Circuit Breaker – User Guide*.

Drawout Device Racking Actions

What's in This Chapter

Drawout MasterPact MTZ1 Device Status	64
Disconnecting the Drawout Device	68
Connecting the Drawout Device	70
Removing the Drawout Device	72
Installing the Drawout Device in the Chassis.....	74

Drawout MasterPact MTZ1 Device Status

Drawout Device Handling Conditions

Connection or disconnection of the drawout device requires insertion of the racking handle. When interlocks, padlocks, or an open door lock are in place, the racking handle cannot be inserted.

⚡ ⚠ DANGER

HAZARD OF ELECTRIC SHOCK, EXPLOSION OR ARC FLASH

- Apply appropriate personal protective equipment (PPE) and follow safe electrical work practices. See NFPA 70E or CSA Z462 or local equivalent.
- This equipment must only be installed and serviced by qualified electrical personnel.

Failure to follow these instructions will result in death or serious injury.

Drawout Device Positions

The indicator located on the front of the chassis locally signals the position of the device in the chassis.

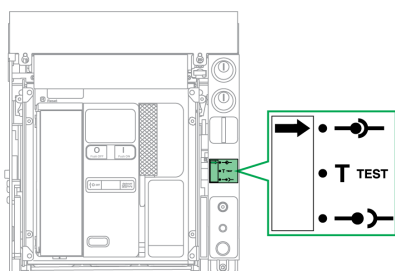

Device position	Position indicator and position contact state	Connector position	Device status
Connected	 	<ul style="list-style-type: none"> • Disconnecting contact clusters: engaged • Control: engaged 	<ul style="list-style-type: none"> • Can be operated. • Ready for service.
Test	 	<ul style="list-style-type: none"> • Disconnecting contact clusters: disengaged - the minimum distance between the device racking terminals and the chassis clusters is reached. 	<ul style="list-style-type: none"> • Can be operated. • Can have operation and control systems tested.

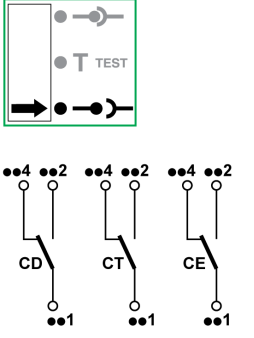
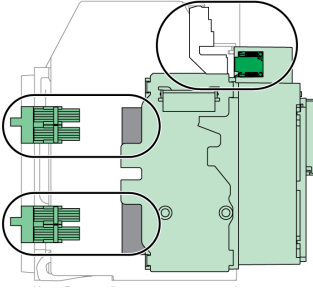
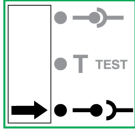
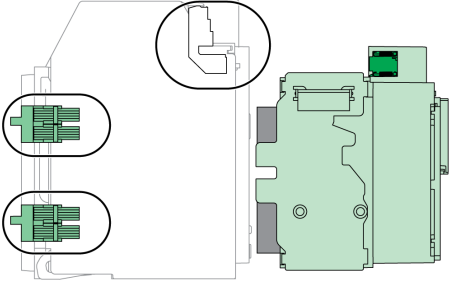
Device position	Position indicator and position contact state	Connector position	Device status
Disconnected		<ul style="list-style-type: none"> Control: engaged  <ul style="list-style-type: none"> Disconnecting contact clusters: disengaged Control: disengaged 	<ul style="list-style-type: none"> Can be operated. Can be removed from chassis.
Withdrawn		 <ul style="list-style-type: none"> Disconnecting contact clusters: disengaged Control: disengaged 	<p>Removed from chassis.</p>

Drawout Device Position Contacts

The position of the device in the chassis is indicated remotely by the following position contacts:

- CE: connected position
- CT: test position
- CD: disconnected position

The state of the position contacts changes according to the device position during racking-in and racking-out operations, as shown in the diagram below.

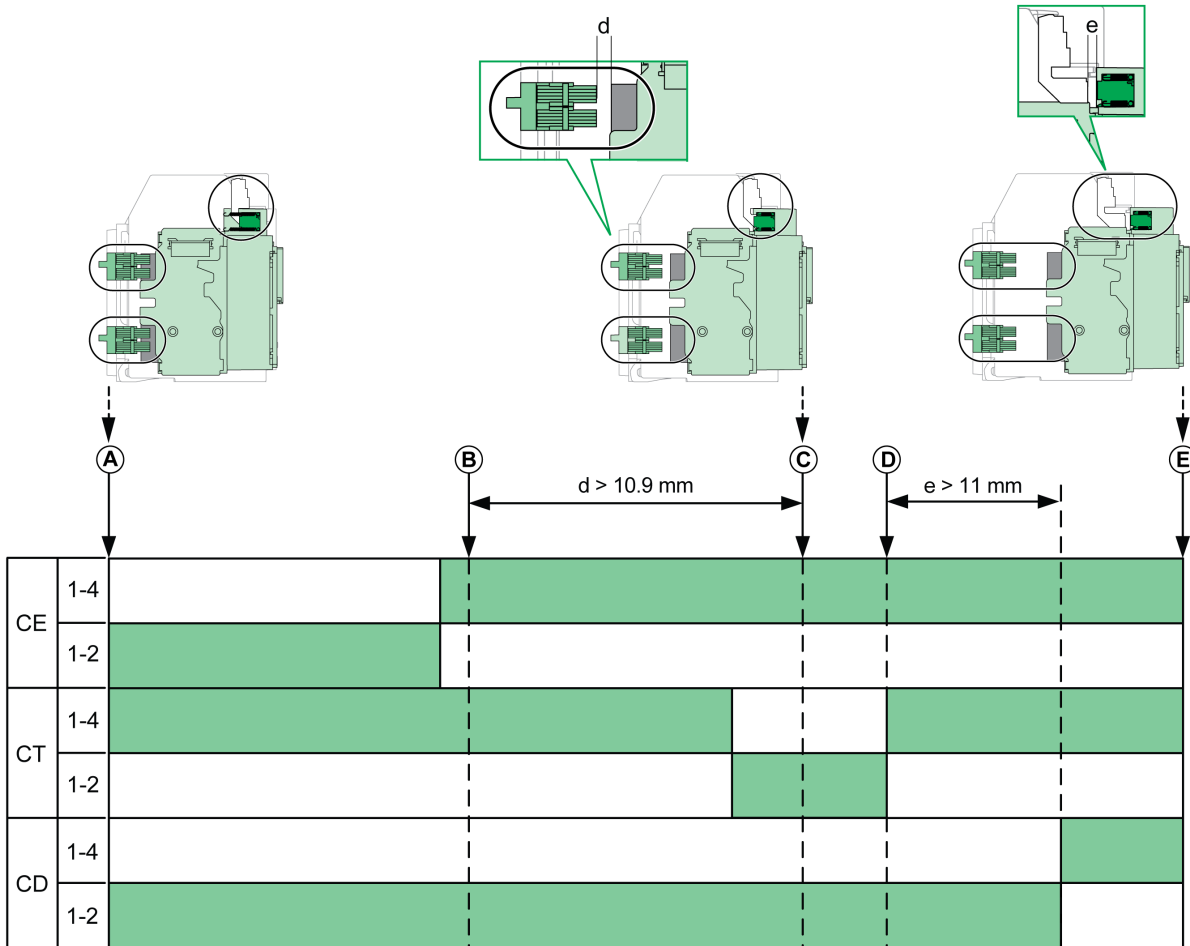

- A** Device in connected position
- B** Separation of the main circuits
- C** Device in test position
- D** Separation of auxiliary circuits
- E** Device in disconnected position

Position contact is open.

Position contact is closed.

Drawout Device Position Contacts Without EIFE Ethernet Interface

Without EIFE Ethernet interface, optional position contacts can be added as follows:

- 2 CD disconnected position contacts
- 3 CE connected position contacts
- 1 CT test position contact

Drawout Device Position Contacts With EIFE Ethernet Interface

With EIFE Ethernet interface, 2 optional CE connected position contacts can be added.

Chassis Management Function

The chassis management function is used to:

- Record and check the position of the moving part of the drawout device in the chassis
- Provide information about preventive maintenance actions
- Notify the remote controller about the position of the drawout device

The chassis management function is performed by:

- The EIFE Ethernet interface, refer to *Enerlin'X EIFE – Embedded Ethernet Interface for One MasterPact MTZ Drawout Circuit Breaker – User Guide*, page 7.
- The IO module, refer to *Enerlin'X IO – Input/Output Application Module for One IEC Circuit Breaker – User Guide*, page 7.

Disconnecting the Drawout Device

Drawout Device Handling Conditions

Connection or disconnection of the drawout device requires insertion of the racking handle. When chassis locking by keylocks, padlocks, or an open door lock are in place, the racking handle cannot be inserted.

⚡ ⚠ DANGER

HAZARD OF ELECTRIC SHOCK, EXPLOSION OR ARC FLASH

- Apply appropriate personal protective equipment (PPE) and follow safe electrical work practices. See NFPA 70E or CSA Z462 or local equivalent.
- This equipment must only be installed and serviced by qualified electrical personnel.

Failure to follow these instructions will result in death or serious injury.

NOTICE

HAZARD OF EQUIPMENT DAMAGE

- Use the provided racking handle to rack the device into or out of chassis.
- Do not use power tools for racking.
- Do not turn the handle after position release button has popped out.

Failure to follow these instructions can result in equipment damage.

Racking-out the Device from Connected to Test Position

Step	Action	
1	Press the opening pushbutton to open the device.	
2	Remove the racking handle from its storage space.	
3	Insert the racking handle into the racking handle socket.	
4	Push in the position release button.	
5	Turn the racking handle counterclockwise. Result: The device moves forward in the chassis.	
6	When the test position is reached, the position release button pops out and the mechanism blocks the racking handle. Result: The device is in the test position.	

Racking-out the Device from Test to Disconnected Position

Step	Action	
1	Push in the position release button.	
2	Turn the racking handle counterclockwise. Result: The device moves forward in the chassis.	
3	When the disconnected position is reached, the position release button pops out and the mechanism blocks the racking handle. Result: The device is in the disconnected position.	
4	Remove the racking handle from the racking socket.	
5	Put the racking handle back into its storage space.	

Connecting the Drawout Device

Drawout Device Handling Conditions

Connection or disconnection of the drawout device requires insertion of the racking handle. When chassis locking by keylocks, padlocks, or an open door lock are in place, the racking handle cannot be inserted.

⚡ ⚠ DANGER

HAZARD OF ELECTRIC SHOCK, EXPLOSION OR ARC FLASH

- Apply appropriate personal protective equipment (PPE) and follow safe electrical work practices. See NFPA 70E or CSA Z462 or local equivalent.
- This equipment must only be installed and serviced by qualified electrical personnel.

Failure to follow these instructions will result in death or serious injury.

NOTICE

HAZARD OF EQUIPMENT DAMAGE

- Use the provided racking handle to rack the device into or out of chassis.
- Do not use power tools for racking.
- Do not turn the handle after position release button has popped out.

Failure to follow these instructions can result in equipment damage.

Racking-in the Device from Disconnected to Test Position

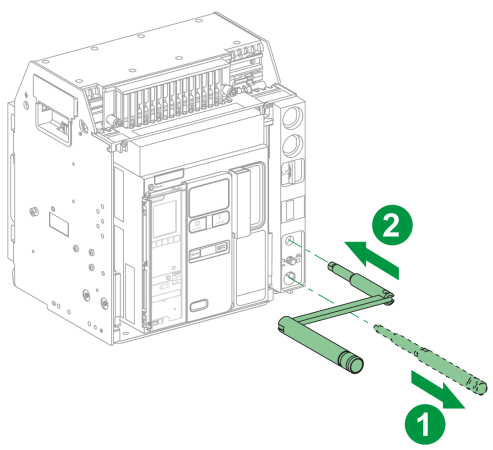
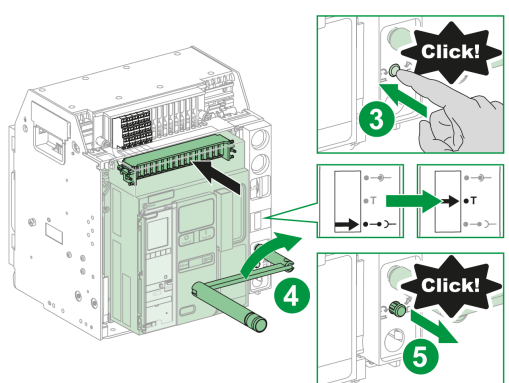
Step	Action	
1	Remove the racking handle from its storage space.	
2	Insert the racking handle into the racking handle socket.	
3	Push the position release button.	
4	Turn the racking handle clockwise. Result: The device moves back in the chassis.	
5	When the test position is reached, the position release button pops out and the mechanism blocks the racking handle. Result: The device is in the test position.	

Racking-in the Device from Test to Connected Position

Step	Action		
1	Push the position release button.		
2	Turn the racking handle clockwise. Result: The device moves back in the chassis.		
3	When the connected position is reached, the position release button pops out and the mechanism blocks the racking handle. Result: The device is in the connected position.		
4	Remove the racking handle from the racking socket.		
5	Put the racking handle back into its storage space.		

Removing the Drawout Device

Device Removal

NOTICE

HAZARD OF EQUIPMENT DAMAGE

The chassis must be securely fastened when installing or removing the device.

Failure to follow these instructions can result in equipment damage.

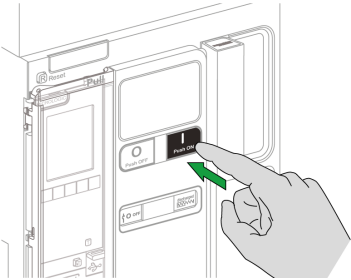
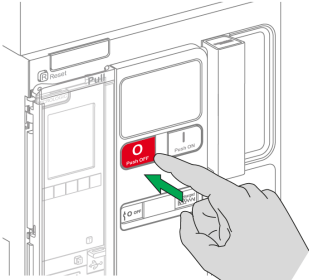
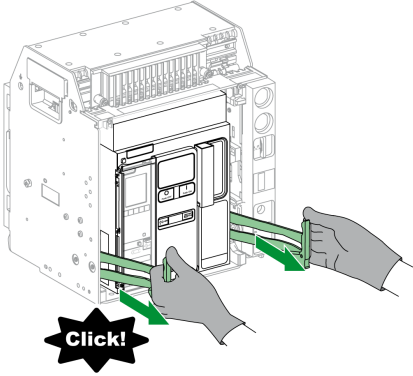
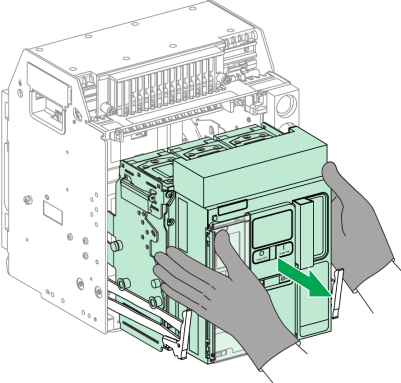
Step	Action	
1	With the device in the disconnected position, page 68, discharge the closing spring by pressing the closing pushbutton. If the closing spring is charged, the device closes.	
2	Press the opening pushbutton to open the device.	
3	Pull out the rails to the maximum by pulling on the drawout grips. The moving part of the drawout device stays in disconnected position in the chassis.	
4	Pull out the moving part of the drawout device to the maximum, by rolling it along the rails. Result: The device is supported on the rails, clear of the chassis and ready to be lifted.	

Lifting the Device

Both the device and chassis have a carrying grip for lifting. To lift the device, use an overhead lifting device attached to the carrying grip, following the directions given in this section.

⚠ DANGER

HAZARD OF DEVICE FALLING

- Be sure that lifting equipment has lifting capacity for the device being lifted.
- Follow manufacturer’s instructions for use of lifting equipment.
- Wear hard hat, safety shoes, and heavy gloves.

Failure to follow these instructions will result in death or serious injury.

Lift the device from the chassis rails by using the carrying grip located on the sides of the device.

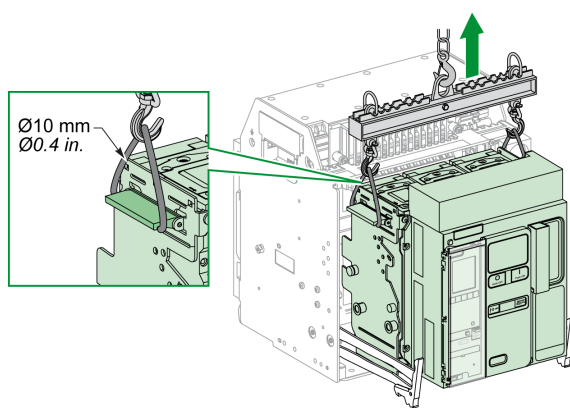

Device Weights

The following table shows the weights of the different devices available.

Number of poles	Device	MTZ1
3P	Moving part (Drawout)	14 kg
	Chassis	16 kg
	Fixed Device	14 kg
4P	Moving part (Drawout)	18 kg
	Chassis	21 kg
	Fixed Device	18 kg

Installing the Drawout Device in the Chassis

Drawout Device Handling Conditions

Connection or disconnection of the drawout device requires insertion of the racking handle. When chassis locking by keylocks, padlocks, or an open door lock is in place, the racking handle cannot be inserted.

DANGER

HAZARD OF ELECTRIC SHOCK, EXPLOSION OR ARC FLASH

- Apply appropriate personal protective equipment (PPE) and follow safe electrical work practices. See NFPA 70E or CSA Z462 or local equivalent.
- This equipment must only be installed and serviced by qualified electrical personnel.

Failure to follow these instructions will result in death or serious injury.

NOTICE

HAZARD OF EQUIPMENT DAMAGE

- Use the provided racking handle to rack the device into or out of chassis.
- Do not use power tools for racking.
- Do not turn the handle after position release button has popped out.

Failure to follow these instructions can result in equipment damage.

Optional Mismatch Protection

Mismatch protection, page 97 allows the installation of a drawout device only in a chassis with compatible characteristics.

Installing the Device

⚠ DANGER

HAZARD OF DEVICE FALLING

- Be sure that lifting equipment has lifting capacity for the device being lifted.
- Follow manufacturer’s instructions for use of lifting equipment.
- Wear hard hat, safety shoes, and heavy gloves.

Failure to follow these instructions will result in death or serious injury.

NOTICE

HAZARD OF EQUIPMENT DAMAGE

- Chassis must be securely fastened when installing or removing the device.
- Before mounting the device, make sure that it matches the chassis.

Failure to follow these instructions can result in equipment damage.

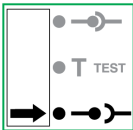
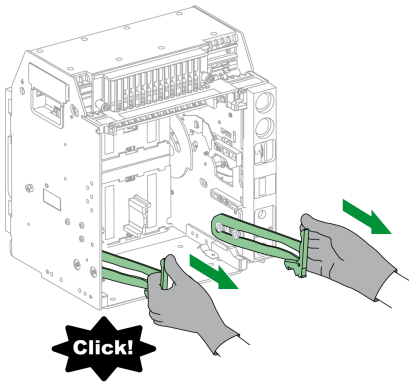
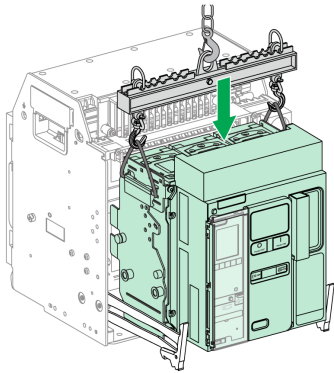
Step	Action
1	If the chassis is not installed yet in a switchboard or panelboard, securely fasten the chassis on a pallet.
2	Remove the racking handle from its storage space.
3	Check that the chassis indicator is in the disconnected position:  If the chassis indicator is not in the disconnected position, follow the steps on disconnecting the drawout device, page 68.
4	Pull out the drawout grips until the extension rails are fully extended. 
5	Install the device on the extension rails by using appropriate lifting equipment. Check that the four wheels on the sides of device are resting on the rails.
6	Detach the lifting equipment.
7	Check that the device is in the open position. 

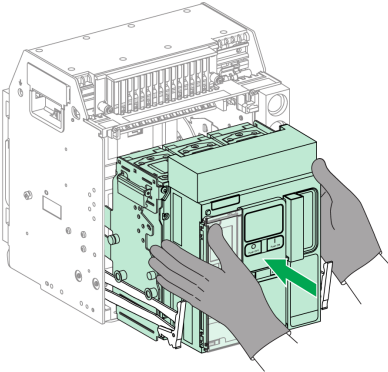
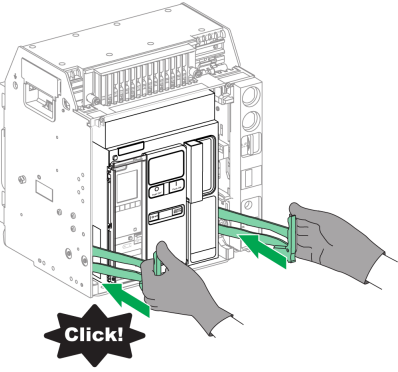
Step	Action	
8	Using both hands, push in the device to the maximum in the chassis. Take care not to push the control unit. The rails stay extended.	
9	When the device is fully inserted into the chassis, lift and push in the rails to the maximum.	

Device Locking Actions

What's in This Chapter

Locking the Pushbuttons.....	78
Locking the Device in Open Position with Padlocks.....	80
Locking the Device in Open Position with Keylocks.....	82
Chassis Locking in Disconnected Position.....	85
Chassis Locking in Any Position.....	90
Locking the Safety Shutters.....	95

About Locking Actions

A locking action is a manual locking operation made by the user. A number of optional locking accessories are available for the MasterPact MTZ1 device and chassis. For a complete listing of available locks, refer to LVPED216026EN *MasterPact MTZ Catalogue*.

Locking the Pushbuttons

Description

The pushbutton locking cover is an optional accessory for the MasterPact MTZ1 device that forbids access to the closing and opening pushbuttons:

- Together or separately.
- By using a padlock (shackle diameter 5–8 mm).
- By using a lead seal.
- By using screws.

IMPORTANT: The use of the pushbutton locking cover is mandatory to padlock the closing pushbutton when a MasterPact MTZ1 device is used as a transfer switch.

For more information, refer to Mechanical Interlocking for Transfer Switches, page 106.

VBP Pushbutton Locking Accessory

The pushbutton locking accessory is an optional transparent cover, mounted on the front cover of the device, which covers the closing and opening pushbuttons.

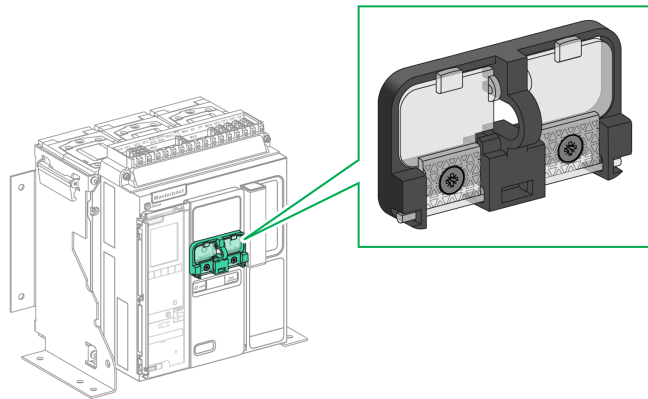

For information on the accessory installation, consult the instruction sheet on the Schneider Electric website: NVE56769.

Locking the Pushbuttons

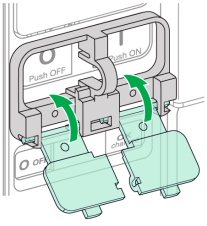
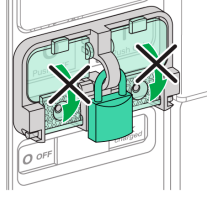
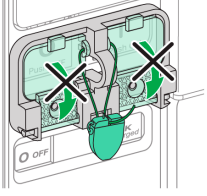
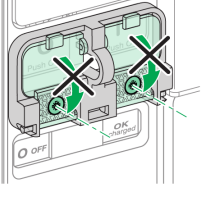
Step	Action	
1	Close the transparent covers of the locking accessory. NOTE: One or both transparent covers of the locking accessory can be closed and locked.	
2	Lock the transparent covers in place by using a padlock, lead seal, or screws.	<p data-bbox="1241 510 1326 539">Padlock</p>  <p data-bbox="1241 757 1342 786">Lead seal</p>  <p data-bbox="1241 1003 1321 1032">Screws</p> 

Locking the Device in Open Position with Padlocks

Description

Optional padlocks can be used to lock the MasterPact MTZ1 in the open position. When locked the device cannot be closed either locally with the closing pushbutton or remotely.

To use padlocks to lock the device in the open position, an optional OFF-position locking accessory is necessary. This accessory allows the use of up to three padlocks with shackle diameter 5–8 mm.

This accessory is not compatible with VSPO OFF-position keylocking accessory, the two accessories cannot be used at the same time.

VCPO OFF-Position Locking Accessory

The off-position locking accessory is an optional accessory that is mounted on the front face of the device.

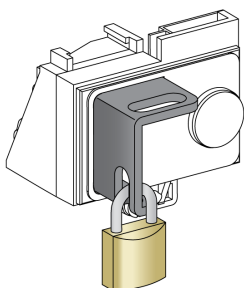

For information on the accessory installation, consult the instruction sheet on the Schneider Electric website: [NVE56770](http://www.schneider-electric.com).

Locking the Device in the Open Position

Step	Action	
1	Press and hold down the opening pushbutton.	
2	With the opening button pressed, pull out the tab of the off-position padlocking accessory.	
3	Insert the padlock in the tab and close the padlock. Release the opening pushbutton.	

Unlocking the Device

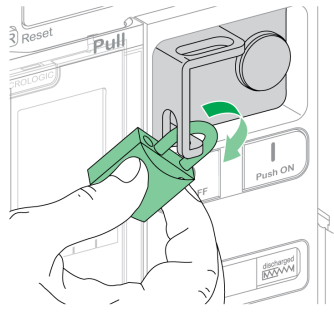
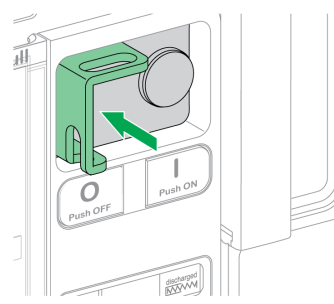
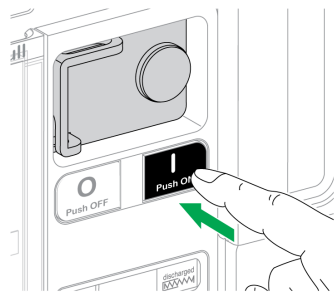
Step	Action	
1	Remove the padlock.	
2	The tab of the OFF-position locking accessory retracts.	
3	Press the closing pushbutton to close the device.	

Locking the Device in Open Position with Keylocks

Description

Optional keylocks can be used:

- To lock one MasterPact MTZ1 in the open position. When locked the device cannot be closed either locally with the closing pushbutton or remotely.
- To interlock several MasterPact MTZ1 devices locked with the same key.

To use keylocks to lock the device in the open position, an optional OFF-position locking accessory is necessary.

This accessory is not compatible with the VCPO OFF-position padlocking accessory, the two accessories cannot be used at the same time.

This accessory is not compatible with the BPFEE closing pushbutton.

VSPO OFF-Position Locking Accessory

The OFF-position locking accessory is an optional accessory that is mounted on the front of the device.

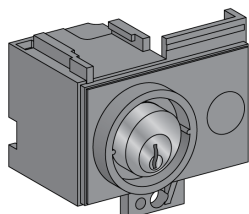

The OFF-position keylocking accessory can be fitted with either:

- One keylock.
- Two keylocks with identical keys or different keys.

The following types of keylocks can be fitted:

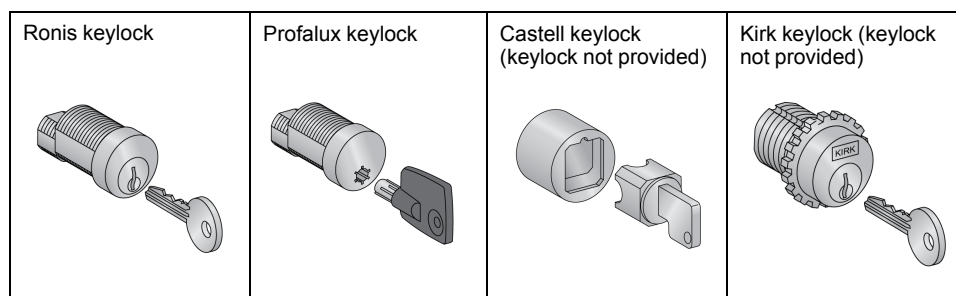

For information on the accessory installation, consult the instruction sheet on the Schneider Electric website: NVE56770.

Locking the Device in the Open Position

For devices equipped with two keylocks, locking with one key is sufficient to lock the device in the open position.

Step	Action	
1	Press and hold the opening pushbutton.	
2	With the opening pushbutton pressed, turn the key clockwise to lock the device.	
3	Remove the key.	
4	Release the opening pushbutton.	
5	Check that the device is locked in the open position and cannot be closed either locally with the closing pushbutton or remotely.	

Unlocking the Device

For devices equipped with two keylocks, both keys must be inserted in the keylocks to unlock the device.

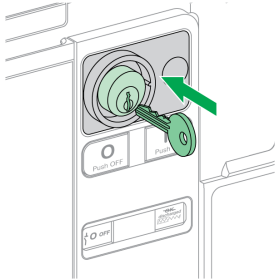
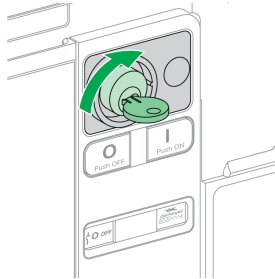
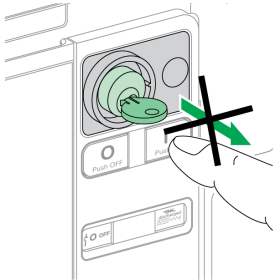
Step	Action	
1	Put the key in the keylock.	
2	Turn the key clockwise to unlock the device.	
3	Press the closing pushbutton to close the device. NOTE: The key remains captive in the keylock.	

Chassis Locking in Disconnected Position

Description

The chassis can be locked in the disconnected position. When the chassis is locked in the disconnected position, the racking handle cannot be inserted.

The chassis can be locked in the disconnected position:

- By up to three padlocks with shackle diameter 5–8 mm.
- By optional keylocks.

Keylocks can be used in addition to padlocks.

Chassis locking by padlock is always possible and does not require any accessory.

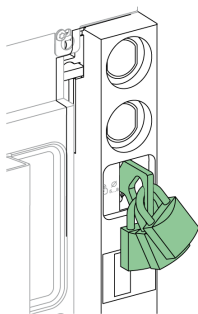

VSPD Chassis Locking by Keylock Accessory

The chassis locking by keylock accessory can be fitted with either:

- One keylock.
- Two keylocks with identical keys or different keys.

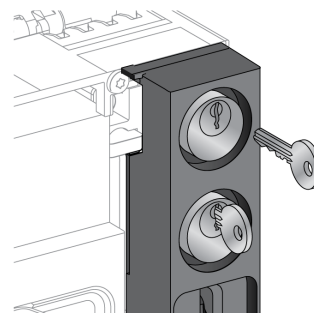
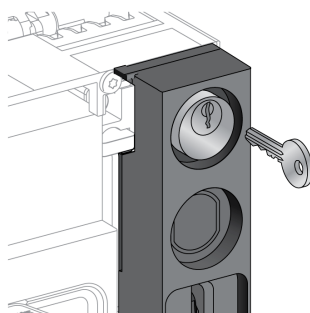

The following types of keylocks can be fitted:

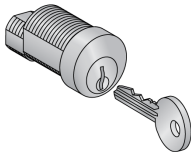
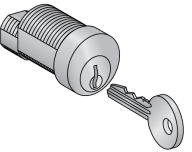
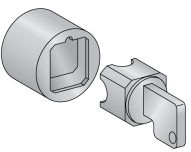
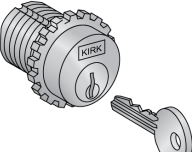
<p>Ronis keylock</p> 	<p>Profalux keylock</p> 	<p>Castell keylock (keylock not provided)</p> 	<p>Kirk keylock (keylock not provided)</p> 
--	---	---	--

For information on the accessory installation, consult the instruction sheet on the Schneider Electric website: [NVE56768](http://www.se.com).

Chassis Locking with Padlocks

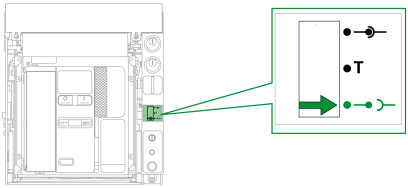
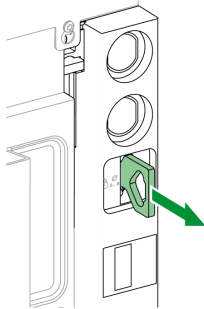
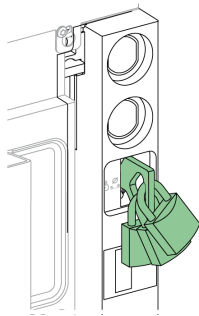
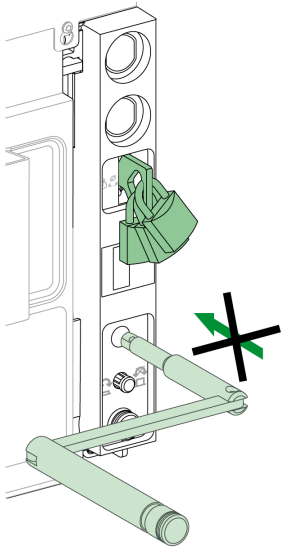
Step	Action	
1	Check that the chassis indicator is in the disconnected position.	
2	Pull out the padlocking tab.	
3	Insert the padlocks in the tab and close the padlocks.	
4	Check that the racking handle cannot be inserted into the racking handle socket.	

Chassis Unlocking with Padlocks

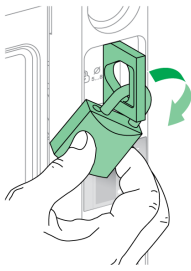
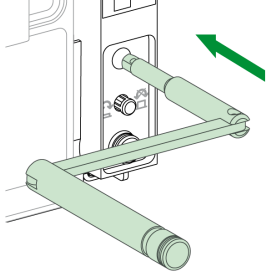
Step	Action	
1	Remove the padlocks. The tab retracts.	
2	Check that the racking handle can be inserted into the racking handle socket.	

Chassis Locking with Keylocks

For chassis equipped with two keylocks, locking with one key is sufficient to lock the chassis in the disconnected position.

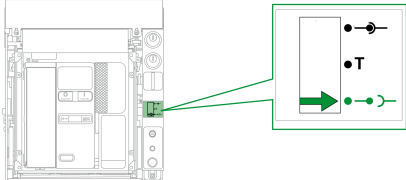
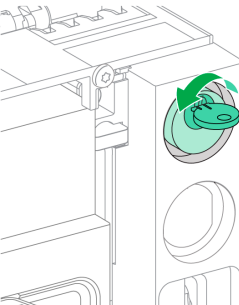
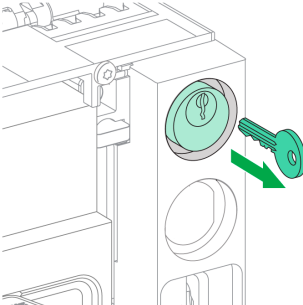
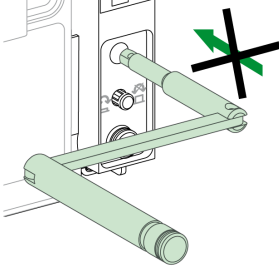
Step	Action	
1	Check that the chassis indicator is in the disconnected position.	
2	Turn the key counterclockwise to lock the chassis.	
3	Remove the key.	
4	Check that the racking handle cannot be inserted into the racking handle socket.	

Chassis Unlocking with Keylocks

For chassis equipped with two keylocks, both keys must be inserted in the keylocks to unlock the chassis.

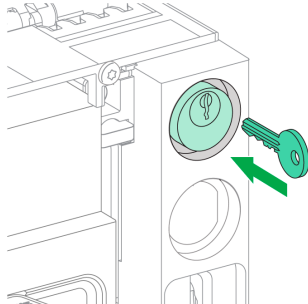
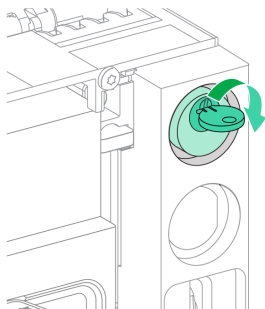
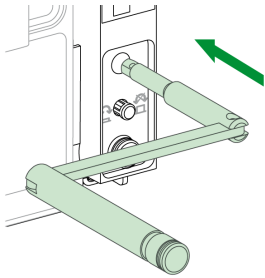
Step	Action	
1	Put the key in the lock.	
2	Turn the key clockwise to unlock the chassis. NOTE: The key remains captive in the keylock.	
3	Check that the racking handle can be inserted into the racking handle socket.	

Chassis Locking in Any Position

Description

The chassis can be locked in any position (connected, test, or disconnected position).

This locking function requires a mechanical adaptation of the chassis, explained in the following procedure.

When the chassis is locked, the racking handle cannot be inserted in the racking handle socket.

The chassis can be locked in any position:

- By up to three padlocks with shackle diameter 5-8 mm as standard.
- By one or two optional keylocks.

Keylocks can be used in addition to padlocks.

VSPD Chassis Locking by Keylock Accessory

The chassis locking by keylock accessory and the locking and unlocking procedures are the same as for the chassis locking in disconnected position, page 85.

Adapting the Chassis

⚠ DANGER

HAZARD OF DEVICE FALLING

- Be sure that lifting equipment has lifting capacity for the device being lifted.
- Follow manufacturer's instructions for use of lifting equipment.
- Wear hard hat, safety shoes, and heavy gloves.

Failure to follow these instructions will result in death or serious injury.

NOTICE

HAZARD OF EQUIPMENT DAMAGE

The chassis must be securely fastened when installing or removing the device.

Failure to follow these instructions can result in equipment damage.

Follow this procedure to adapt the chassis locking mechanism so that the chassis can be locked in any position.

Stage	Description
1	Removing the terminal block identification plate and the chassis front cover. (Refer to the following procedure)
2	Changing the position of the lock, page 92.
3	Reinstalling the chassis front cover and the terminal block identification plate, page 94.

Removing the Terminal Block Identification Plate and the Chassis Front Cover

Before starting the procedure, check that the device is in the disconnected position, page 68 and remove the device from the chassis, page 72.

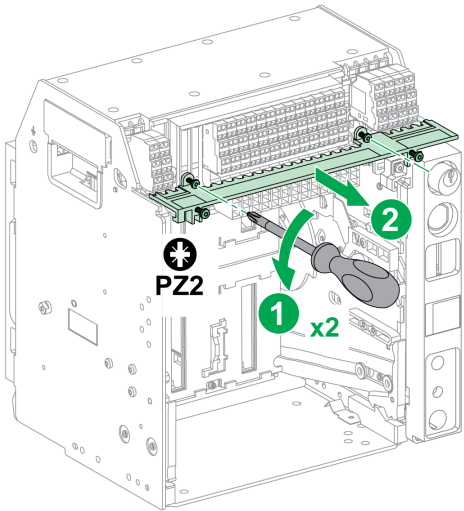
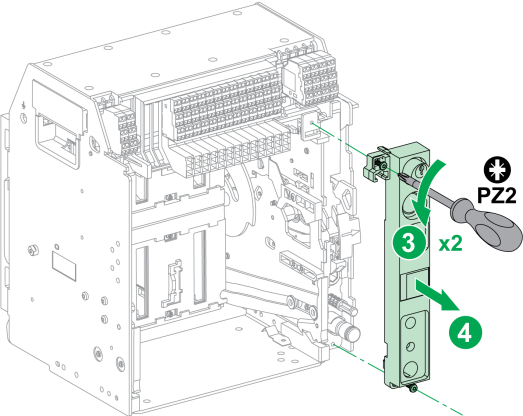
Step	Action	
1	Remove the two screws holding the terminal block identification plate in place, by using a PZ2 screwdriver.	
2	Carefully pull out the terminal block identification plate.	
3	Remove the two screws holding the chassis front cover in place, by using a PZ2 screwdriver.	
4	Pull off the chassis front cover.	

Changing the Position of the Lock

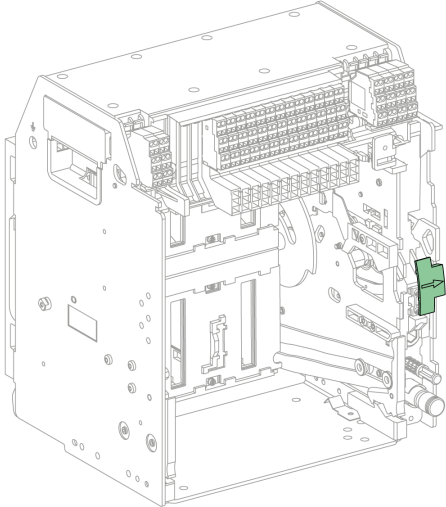
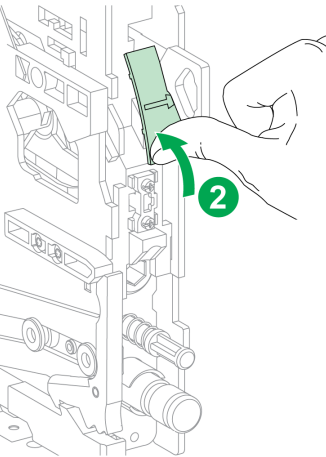
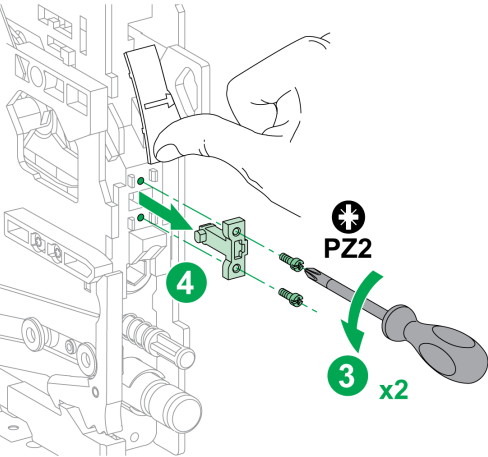
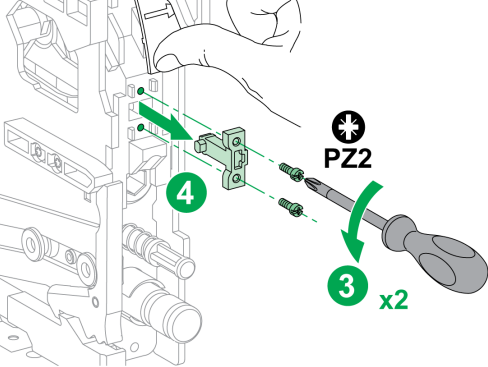
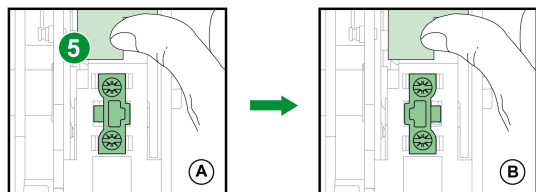
Step	Action	
1	Identify the position of the plastic cover of the lock.	
2	Lift the plastic cover of the lock and hold it up.	
3	Remove the two screws holding the lock in place, by using a PZ2 screwdriver.	
4	Remove the lock.	
5	Rotate the lock through 180° to change from locking in disconnected position (A) to locking in any position (B).	

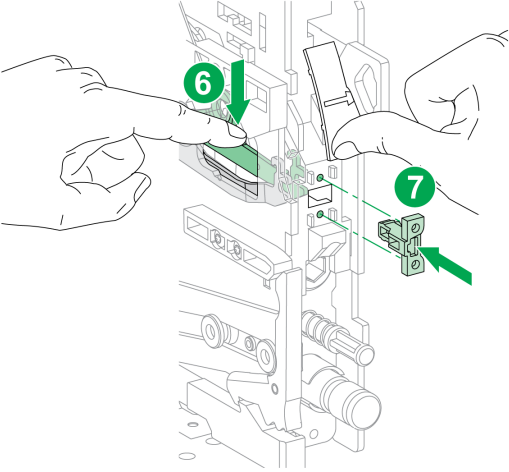
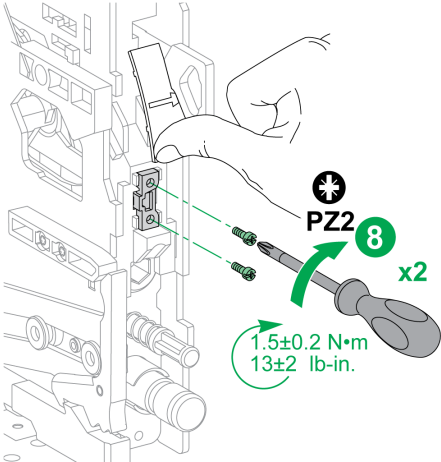
Step	Action	
6	Use your finger to press down the tab behind the lock slot.	
7	Insert the lock, making sure that the notch is on the left side.	
8	<p>Screw the lock into position with the two screws, by using a PZ2 screwdriver.</p> <p>Release the plastic cover to allow it to drop back into place</p>	

Reinstalling the Chassis Front Cover and the Terminal Block Identification Plate

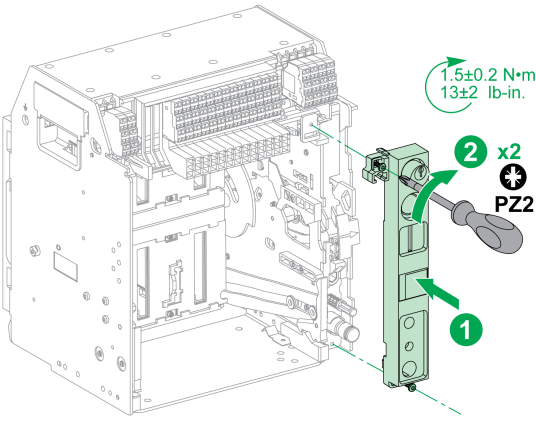
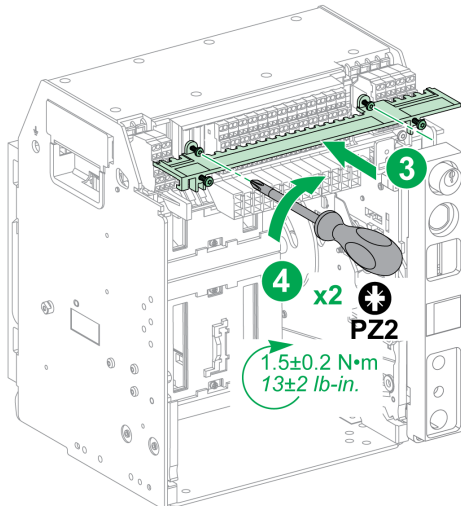
Step	Action	
1	Reinstall the chassis front cover.	
2	Screw the front cover into position with the two screws, by using a PZ2 screwdriver.	 <p>1.5±0.2 N·m 13±2 lb-in.</p> <p>2 x2 PZ2</p>
3	Slide the terminal block identification plate into place.	
4	Screw the terminal block identification plate in with the two screws, by using a PZ2 screwdriver.	 <p>1.5±0.2 N·m 13±2 lb-in.</p> <p>4 x2 PZ2</p>

Locking the Safety Shutters

Description

A shutter lock locks the safety shutter in closed position so that a drawout MasterPact MTZ1 device cannot be connected in its chassis.

The top and bottom safety shutters can be locked independently.

Locking the Safety Shutters

Place two padlocks on the top and bottom shutter locking guides to lock the shutters.

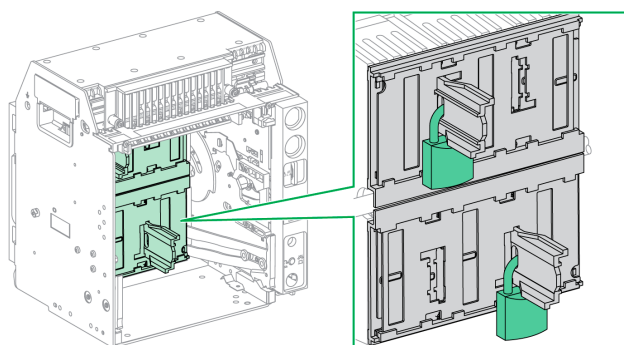

For more information, refer to the instruction sheet: NVE35509.

Device Interlocking Actions

What's in This Chapter

Mismatch Protection	97
VPEC Door Interlock	99
VPOC Open-door Racking Interlock	102
IPA Cable-type Door Interlock	105
Mechanical Interlocking for Transfer Switches	106

About Interlocking Actions

An interlocking action is an automatic locking operation provided by interlocking accessories added to the MasterPact MTZ1 device or chassis.

A number of optional interlocking accessories are available for the MasterPact MTZ1 device and chassis. For a complete listing of available interlocks, refer to LVPED216026EN *MasterPact MTZ Catalogue*.

For detailed installation instructions on field-installable interlocks, refer to the installation instructions shipped with these accessories.

Mismatch Protection

Description

Mismatch protection allows the installation of a MasterPact MTZ1 device only in a chassis with compatible characteristics.

Mismatch protection offers 35 different combinations that can be selected so that a device can only be mounted on a chassis with the matching combination.

Accessory

The use of mismatch protection is optional. One mismatch protection accessory is required for each device.

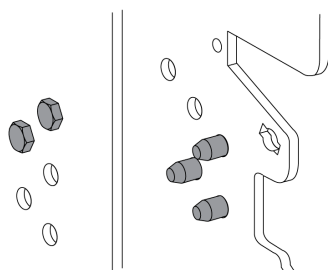

For information on the accessory installation, consult the instruction sheet available at Schneider Electric website: NVE35465.

Pin Location of Mismatch Protection

The following illustration shows the pin location on the chassis and device, respectively.

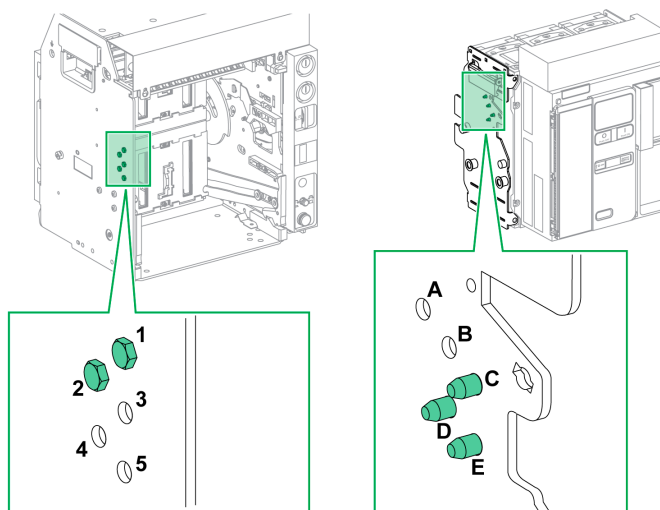

The pin combination selected on the chassis must correspond to the pin combination selected on the device (see following table). For example, the combination 12 on the chassis corresponds to the combination CDE on the device.

Pins on the chassis are labeled 1, 2, 3, 4, 5.

Pins on the device are labeled A, B, C, D, E.

Recommended Pin Combinations

The following are the recommended pin combinations:

Pins on chassis	Pins on device	Pins on chassis	Pins on device
45	ABC	15	BCD
35	ABD	14	BCE
34	ABE	145	BC
345	AB	13	BDE
25	ACD	135	BD
24	ACE	134	BE
245	AC	12	CDE
23	ADE	125	CD
235	AD	124	CE
234	AE	123	DE

VPEC Door Interlock

Description

With the door interlock:

- The equipment door is locked and cannot be opened when the drawout device is in connected or test position.
- The equipment door can be opened when the drawout device is in disconnected position.
- The equipment door can be closed with the drawout device in any position.

Accessory

The VPEC door interlock accessory is an optional accessory that is mounted on the left side or on the right side of the chassis. One door interlock is necessary for each chassis.

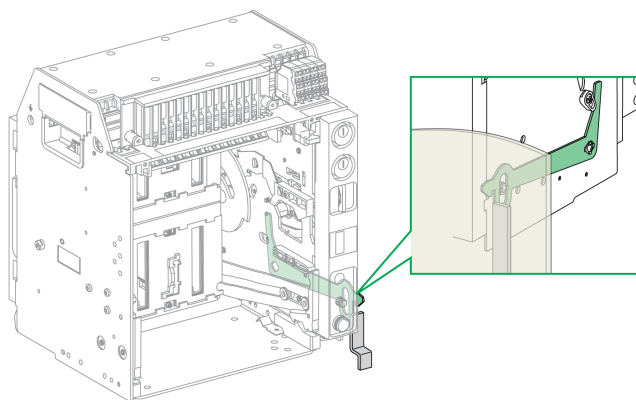

For information on the accessory installation, consult the instruction sheet available at Schneider Electric website: [NVE35519](https://www.schneider-electric.com/resources/technical-documents/NVE35519).

Locking the Equipment Door

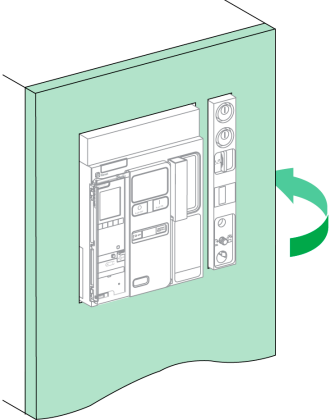
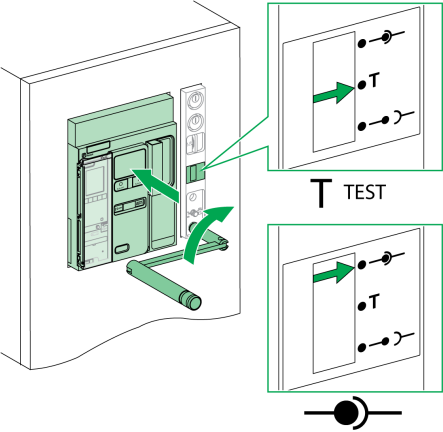
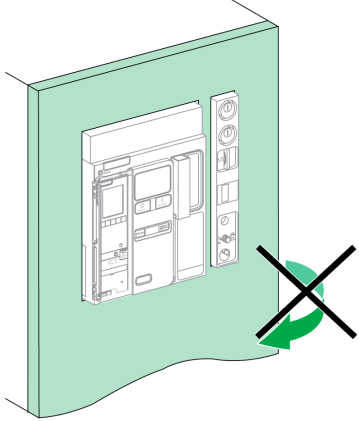
Step	Action	
1	Close the equipment door.	
2	Put the device into the test or connected position, page 70.	
3	Check that the equipment door is locked.	

Unlocking the Equipment Door

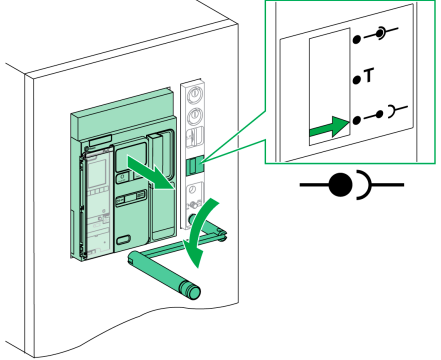
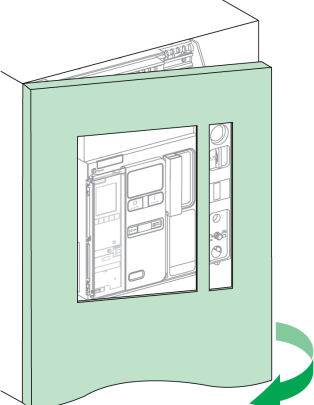
Step	Action	
1	Put the device into the disconnected position, page 68.	
2	Check that the equipment door is unlocked.	

VPOC Open-door Racking Interlock

Description

With the racking interlock installed, a drawout MasterPact MTZ1 device cannot be racked in or out when the equipment door is open because the racking handle cannot be inserted.

Accessory

The optional VPOC racking interlock can be installed on the right side of the chassis.

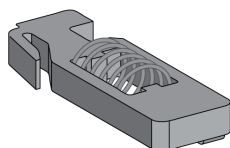

For information on the accessory installation, consult the instruction sheet on the Schneider Electric website: [NVE35520](http://www.schneider-electric.com).

Activating the Racking Interlock

Step	Action	
1	Remove the door.	
2	Insert the racking interlock.	

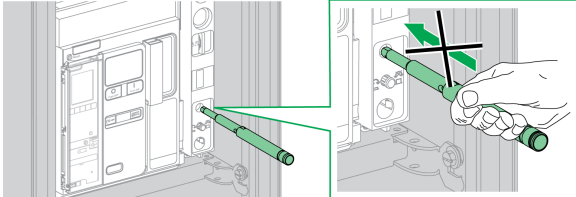
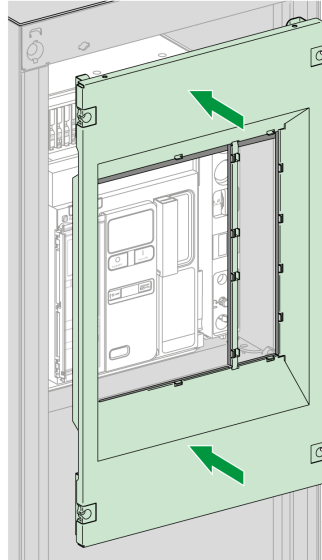
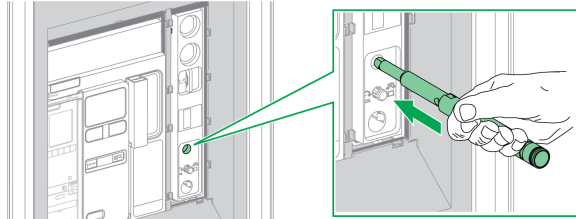
Step	Action	
3	Check that the racking handle cannot be inserted into the racking handle socket when the equipment door is open.	
4	Replace the door.	
5	Check that the racking handle can be inserted into the racking handle socket when the equipment door is closed.	

Deactivating the Racking Interlock

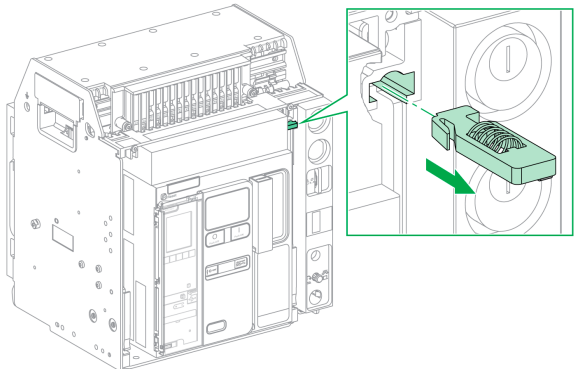
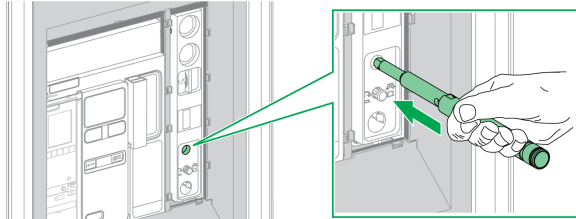
Step	Action	
1	Pull out the racking interlock.	
2	Check that the racking handle can be inserted into the racking handle socket when the equipment door is open or closed.	

IPA Cable-type Door Interlock

Description

When the cable-type door interlock is installed, the door cannot be opened when the device is closed and the device cannot be closed when the door is open.

The cable-type door interlock comprises a plate, a lock, and a cable. It is mounted on the right-hand side of the device.

When the interlock is installed, the mechanical interlock for transfer switches cannot be implemented.

Accessory

The IPA cable-type door interlock is an optional accessory.

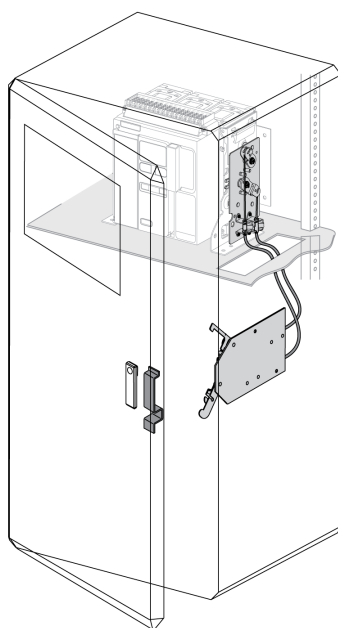

For information on the accessory installation, consult the instruction sheet available on the Schneider Electric website: [NVE35521](https://www.se.com).

Mechanical Interlocking for Transfer Switches

Description

The mechanical interlocking for transfer switches between two MasterPact MTZ1 devices prevents the two interlocked devices from closing at the same time.

VBP Pushbutton Locking Accessory

The VBP pushbutton locking accessory provides redundancy in addition to the mechanical interlocking system.

The use of the pushbutton locking cover is mandatory on each interlocked MasterPact MTZ device. The closing pushbuttons of the interlocked devices must be locked by padlocks sharing one key to help avoid simultaneous closing orders of interlocked devices.

For more information about the pushbutton locking cover, refer to VBP Pushbutton Locking Accessory, page 78

Mechanical Interlocking Between Two Devices

Two devices can be mechanically interlocked by cables or by rods so that both devices cannot be closed at the same time.

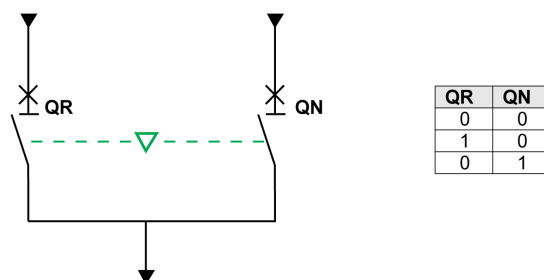

For information on the accessory installation, consult the instruction sheet on the Schneider Electric website:

- For Interlocking by cables: NVE35522
- For Interlocking by rods: NVE35523

IVE Electrical Interlocking Unit

Electrical interlocking between MasterPact MTZ devices can be done using the IVE electrical interlocking unit or by using dedicated wiring. The IVE unit is suitable for two devices only. For three devices, dedicated wiring is required to perform the electrical interlocking.

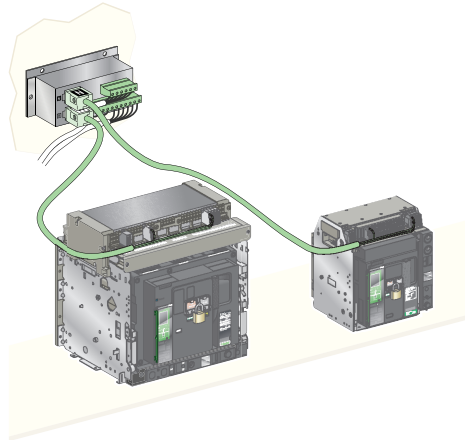

For information on the accessory installation, consult the instruction sheet on the Schneider Electric website: [51201201AA](https://www.schneider-electric.com/51201201AA)

MasterPact MTZ Critical Cases

What's in This Part

Finding the Cause of a Trip or an Alarm in Critical Cases.....	109
Resetting the Circuit Breaker After a Trip Due to an Electrical Fault.....	113
Resetting the Circuit Breaker After a Trip Due to an Incident Detected by the MicroLogic X Self-tests	116
Diagnosing Alarms	118
Diagnosing Error Messages	125

Finding the Cause of a Trip or an Alarm in Critical Cases

Definitions

While operating the device, the user may face two critical cases:

- The circuit breaker has tripped automatically, interrupting the power supply.
- The circuit breaker has not tripped, but the MicroLogic X control unit has detected an alarm:
 - For a high severity alarm, the service LED is red, indicating that urgent corrective action is required.
 - For a medium severity alarm, the service LED is orange, indicating that corrective action needs to be scheduled.

Notification of a Trip or Alarm

A trip or alarm event is signaled:

- On the MicroLogic X control unit HMI, by the trip cause LEDs or the service LED. When the control unit is powered, a red or orange pop-up message is displayed on the screen.
- By the SDE fault-trip indication contact

Depending on the options installed, a trip or alarm can also be signaled:

- By an additional SDE2 fault-trip indication contact
- By the outputs of the M2C programmable contacts
- By the outputs of an IO application module
- By an email sent through IFE or EIFE Ethernet interface
- On a remote controller connected to the communication network (application customized by user)
- On the FDM128 display
- On the FDM121 display

Active alarms can also be consulted in the following ways:

- On a smartphone with EcoStruxure Power Device app connected to the MicroLogic X control unit:
 - Through Bluetooth
 - Through USB OTG connection
- On EcoStruxure Power Commission software connected to the MicroLogic X control unit:
 - Through USB connection
 - Through IFE or EIFE Ethernet interface
 - Through IFM Modbus-SL interface

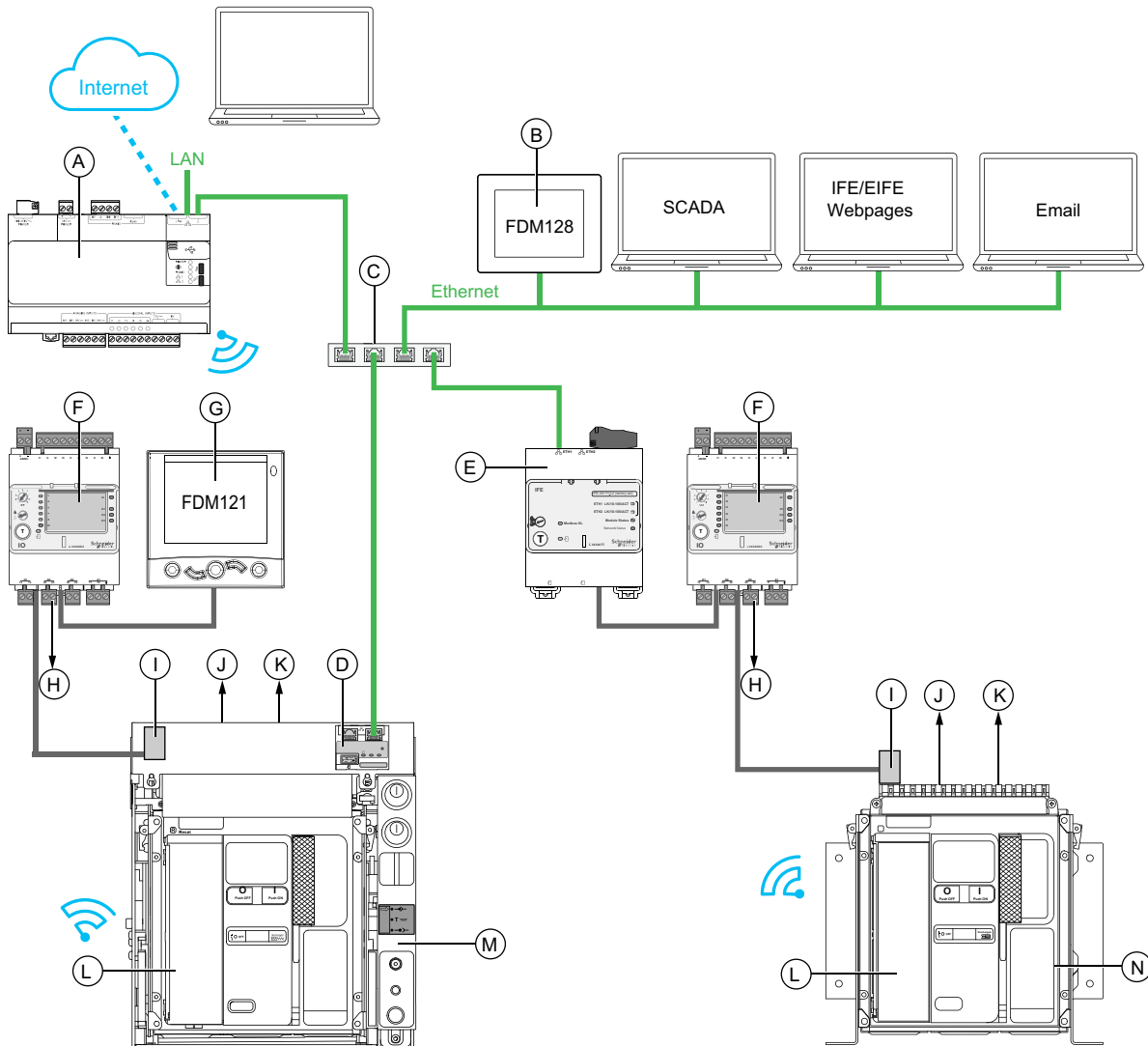

- A** Com'X energy server
- B** FDM128 Ethernet display for eight devices
- C** Ethernet switch
- D** EIFE embedded Ethernet interface for one MasterPact MTZ drawout circuit breaker
- E** IFE Ethernet interface for one MasterPact MTZ circuit breaker
- F** IO input/output application module for one circuit breaker
- G** FDM121 front display module for one circuit breaker
- H** IO module outputs used for event notification
- I** ULP port module
- J** One or two SDE fault-trip indication contacts
- K** Two optional M2C programmable contacts
- L** MicroLogic X control unit
- M** Drawout MasterPact MTZ circuit breaker
- N** Fixed MasterPact MTZ circuit breaker

Identifying the Cause of a Trip or Alarm Using the MicroLogic X Control Unit

In critical situations, the cause of a trip or an alarm can be identified locally by using one of the following:

- The blue fault-trip reset button on the circuit breaker (**A**). When the trip button is popped out, the trip has occurred.
- The indicators on the MicroLogic X control unit, page 112:
 - The **Ready** LED (**B**)
 - The service LED (**C**)
 - The MicroLogic X display screen (**D**)
 - The trip cause LEDs (**E**)
- A smartphone with EcoStruxure Power Device app installed to get the trip cause, the trip or alarm context, and the device ID:
 - Through NFC
 - Through Bluetooth
 - Through USB OTG connection

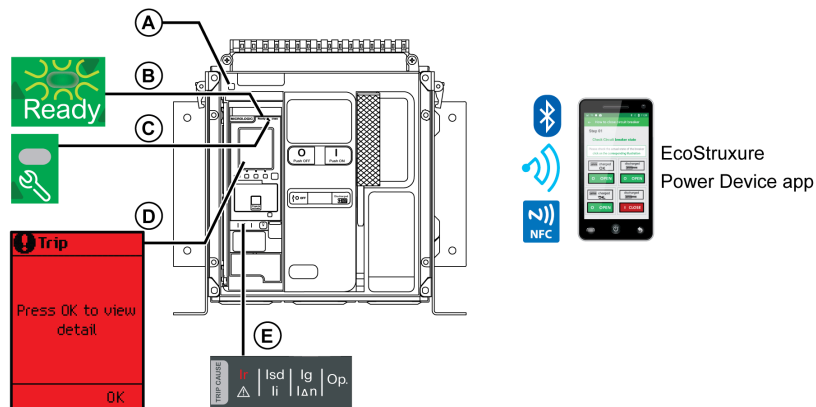

A Blue fault-trip reset button

B Ready LED

C Service LED

D MicroLogic X display screen

E Trip cause LEDs

NOTE: The optional Power Restoration Assistant Digital Module provides assistance with restoring power after a trip. For more information, refer to DOCA0102EN *MasterPact MTZ – MicroLogic X Control Unit – User Guide*.

Availability of Diagnostic Data After a Trip

The diagnostic data is available when the MicroLogic X control unit is powered.

If the MicroLogic X control unit is not permanently powered by an external 24 Vdc power source, connect the MicroLogic X control unit to an external power supply, for example, the Mobile Power Pack, through the mini USB port to have access to the diagnostic data.







When the MicroLogic X control unit is powered externally, the availability of diagnostic data depends on the MicroLogic X state:

- If the MicroLogic X control unit is operative, all diagnostic data is available.
- If the MicroLogic X control unit is inoperative, no data is directly available. However, some data can be extracted using the NFC function with the EcoStruxure Power Device app.

The trip cause LEDs and the red service LED are powered by the MicroLogic X internal lithium battery and remain on for 4 hours when there is no other power to the control unit. To switch on the trip cause LEDs or the red service LED again after 4 hours, press the Test/Reset button.

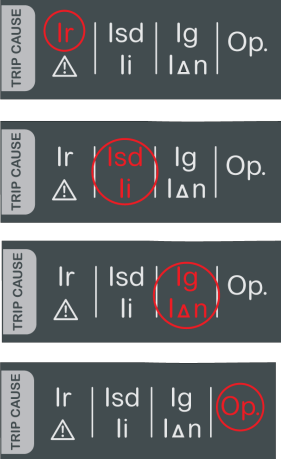





Using the Display Screen and LEDs to Find the Cause of a Trip

The circuit breaker has tripped automatically, interrupting the power supply, and the blue fault-trip reset button has popped out.

Ready LED	Service LED	MicroLogic X display screen	Trip cause LEDs	Description
<p>Ready LED flashing green.</p> 	<p>Service LED off.</p> 		<p>One of the trip cause LEDs is on red.</p> 	<p>Electrical fault on the network, page 113</p>
<p>Ready LED off.</p> 	<p>Service LED on red.</p> 		<p>All LEDs are on.</p> 	<p>Major MicroLogic X control unit incident detected during self-test, page 116</p>

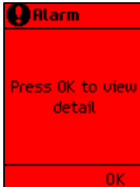
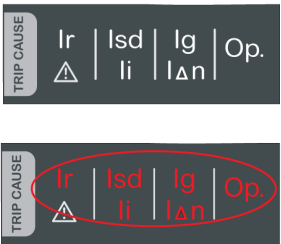
Using the Display Screen and LEDs to Find the Cause of an Alarm

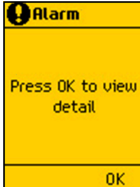
The circuit breaker has not tripped, but the MicroLogic X control unit service LED is on.

Ready LED	Service LED	MicroLogic X display screen	Trip cause LEDs	Description
<p>Ready LED flashing green or Ready LED off.</p>  	<p>Service LED on red.</p> 		<p>All LEDs are off or all LEDs are on.</p> 	<p>High severity alarm, page 118</p>
<p>Ready LED flashing green.</p> 	<p>Service LED on orange.</p> 		<p>All LEDs are off.</p> 	<p>Medium severity alarm, page 120</p>

Resetting the Circuit Breaker After a Trip Due to an Electrical Fault

Reset Sequence

 **DANGER**

HAZARD OF ELECTRIC SHOCK, EXPLOSION, OR ARC FLASH

Do not re-close the device on an electrical fault. First inspect and, if necessary, repair the downstream equipment.







Failure to follow these instructions will result in death or serious injury.

The table shows the sequence of actions to follow after a trip due to an electrical fault. Further explanation of each action is given in the following paragraphs.

Step	Action
1	Identify the trip cause.
2	Press OK to view details of the trip cause on the display screen.
3	Consult the two trip cause context screens: <ul style="list-style-type: none"> • Screen 1: Name and settings of the tripping protection, date and time of the trip. • Screen 2: Current values recorded before the trip.
4	Clear the electrical fault on the network.
5	Inspect the circuit breaker and switchboard after a short circuit.
6	Press OK to acknowledge the trip cause and return to the Home menu. NOTE: If the trip cause is not acknowledged within the event timeout, the pop-up is displayed again.
7	Reset the circuit breaker, page 52.
8	Press the Test/Reset button for 3 seconds to reset the latched events and switch off the trip cause LEDs.
9	When the circuit breaker is ready-to-close, re-close it, page 49.

NOTE: You may use the EcoStruxure Power Device app with the Power Restoration Assistant Digital Module to get support while resetting after a trip due to an electrical fault.

Identifying the Trip Cause

Ready LED	Service LED	MicroLogic X display screen	Trip cause LEDs	Description
<p>Ready LED flashing green.</p> 	<p>Service LED off.</p> 			<ul style="list-style-type: none"> MicroLogic 2.0 X, 5.0 X, 6.0 X, 7.0 X: trip due to the long-time protection.
				<ul style="list-style-type: none"> MicroLogic 2.0 X: trip due to the instantaneous protection. MicroLogic 5.0 X, 6.0 X, 7.0 X: trip due to the short-time protection or instantaneous protection.
				<ul style="list-style-type: none"> MicroLogic 2.0 X, 5.0 X: not used. MicroLogic 6.0 X: trip due to the ground-fault protection. MicroLogic 7.0 X: trip due to the earth-leakage protection.
				<ul style="list-style-type: none"> MicroLogic 2.0 X, 5.0 X, 6.0 X, 7.0 X: trip due to optional protections.

NOTE: Diagnostic assistance can be obtained by using a smartphone running the EcoStruxure Power Device app.

Clearing the Electrical Fault

DANGER

HAZARD OF ELECTRIC SHOCK, EXPLOSION, OR ARC FLASH

- Apply appropriate personal protective equipment (PPE) and follow safe electrical work practices. See NFPA 70E or CSA Z462 or local equivalent.
- This equipment must be installed and serviced by qualified electrical personnel.
- Turn off all power supplying this equipment before performing maintenance inspections. Assume that all circuits are live until they are de-energized, tested, grounded, and tagged. Consider all sources of power, including the possibility of backfeeding and control power.
- Always use a properly rated voltage sensing device to confirm that power is off.
- Replace all devices, doors, and covers before turning on power to this equipment.
- Beware of potential hazards and carefully inspect the work area for tools and objects that may have been left inside the equipment.

Failure to follow these instructions will result in death or serious injury.

DANGER

HAZARD OF ELECTRIC SHOCK, EXPLOSION, OR ARC FLASH

Do not re-close the device on an electrical fault. First inspect and, if necessary, repair the downstream equipment.

Failure to follow these instructions will result in death or serious injury.

The feed must be isolated before inspecting the electrical equipment downstream of the protection.

The fact that a circuit breaker has tripped does not remedy the cause of the electrical fault detected on the downstream electrical equipment.

Inspecting the Circuit Breaker and Switchboard After a Trip on Short Circuit

After a trip on short circuit due to short-time or instantaneous protection, the circuit breaker and switchboard must be inspected for smoke deposits or cracks in the device casing.

Refer to DOCA0099EN *MasterPact MTZ - IEC Circuit Breakers and Switch-Disconnectors - Maintenance Guide* and contact your field service representative.







Resetting the Circuit Breaker After a Trip Due to an Incident Detected by the MicroLogic X Self-tests

Reset Sequence

The following table shows the sequence of actions to take after a trip due to an incident detected by the MicroLogic X control unit. Further explanation of each action is given in the following paragraphs.

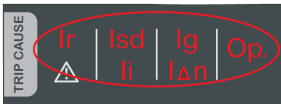
Step	Action
1	Identify the trip cause.
2	Press OK to view details of the trip cause on the display screen: <ul style="list-style-type: none"> • A code that identifies the trip cause. • A trip message describing the cause of the incident. • The date and time that the incident occurred.
3	Consult the list of possible detected incidents, page 117 and perform the actions recommended to restart after the trip.
4	Press OK to acknowledge the trip and return to the Home menu.
5	Reset the circuit breaker, page 52.
6	Press the Test/Reset button for 3 seconds to reset the latched events and switch off the trip cause LEDs and the service LED.
7	When the circuit breaker is ready to close, re-close it, page 49.

Identifying the Trip Cause

Ready LED	Service LED	MicroLogic X display screen	Trip cause LEDs	Description
<p>Ready LED off.</p> 	<p>Service LED on red.</p> 		<p>All LEDs are on.</p> 	<p>Major MicroLogic X control unit incident detected during self-test, page 117.</p>
<p>Ready LED flashing green.</p> 	<p>Service LED off.</p> 		<p>Op. LED is on.</p> 	<p>Circuit breaker incident detected during self-test, page 117.</p>

Recommended Actions After a Trip Due to a MicroLogic X Incident

The following table indicates what action to perform according to the trip message.

For more information, refer to the event messages in DOCA0102EN *MasterPact MTZ – MicroLogic X Control Unit – User Guide*.

Code	Trip message	Description	Recommended action
0x1400 0x1404 0x1405 0x1406 0x1416	Control unit self test major malfunction	The control unit self test detected a major malfunction in the control unit operation. NOTE: The malfunction trips or does not trip the circuit breaker, depending on the malfunction detected.	Plan to replace the MicroLogic X control unit.
0x1402	Internal current sensor disconnected	The control unit self test detected the disconnection of an internal sensor of the circuit breaker.	Plan to replace the MicroLogic X control unit.
0x1403	External neutral current sensor disconnected	The control unit self-test detected the disconnection of the external neutral current sensor of the circuit breaker.	Check connection of the External Neutral Current Sensor (ENCT).
0x6407	Self diagnostic trip	The circuit breaker tripped following a control unit microprocessor (Asic) invalid result.	Plan to replace the MicroLogic X control unit.
0x641F	Replace Circuit Breaker. Self Diagnostic	The circuit breaker tripped following a major malfunction of one or two internal current power supply sensors of the circuit breaker.	Replace the circuit breaker.

Diagnosing Alarms

Diagnosis Sequence

The following table shows the sequence of actions to take after an alarm is detected by the MicroLogic X control unit. Further explanation of each action is given in the following paragraphs.

Step	Action
1	Identify the alarm detected.
2	Press OK to view details of the alarm detected on the display screen: <ul style="list-style-type: none"> • An alarm message. • The date and time that the alarm occurred.
3	Consult the list of alarm messages in the following tables and perform the actions recommended.
4	Press OK to acknowledge the alarm and return to the Home menu.
5	Press the Test/Reset button for 3 seconds to reset the latched events and switch off the trip cause LEDs and the service LED.









Identifying the Alarm Detected

The MicroLogic X control unit indicates alarms with:

- The **Ready** LED (flashing green or off)
- The service LED (red or orange)
- A pop-up alarm screen (red or orange)

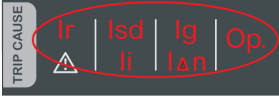
Two levels of alarm are detected and indicated by the color of the service LED:

- Red for high-severity detected alarms.
- Orange for medium-severity detected alarms.

Ready LED	Service LED	MicroLogic X display screen	Trip cause LEDs	Description
<p>Ready LED flashing green or Ready LED off.</p>  	<p>Service LED on red.</p> 		<p>All LEDs are off or all LEDs are on.</p>  	<p>High severity alarm, page 118</p>
<p>Ready LED flashing green.</p> 	<p>Service LED on orange.</p> 		<p>All LEDs are off.</p> 	<p>Medium severity alarm, page 120</p>

Recommended Action After Detection of High Severity Alarms

The following table indicates what action to perform according to the alarm message.

For more information, refer to the event messages in *DOCA0102EN MasterPact MTZ – MicroLogic X Control Unit – User Guide*.

Code	Alarm message	Alarm description	Recommended action
0x1400 0x1404 0x1405 0x1406 0x1416	Control unit self test major malfunction	The control unit self test detected a major malfunction in the control unit operation. NOTE: The malfunction trips or does not trip the device, depending on the malfunction detected.	Plan to replace the MicroLogic X control unit.
0x1408	Earth leakage (Vigi) sensor disconnected	The control unit self test detected the disconnection of an earth leakage (Vigi) sensor.	Check the connection of the external earth leakage (Vigi) sensor.
0x1409	Unable to read sensor plug	The control unit is unable to read the value of the sensor plug.	Check connection of the sensor plug and performer plugs. If the connection is good but it fails again, replace the sensor plug or the control unit.
0x1413	IΔn/Ig test - no trip	The earth-leakage (IΔn)/ground (Ig) did not trip.	Restart the test. If it fails again, replace the control unit.
0x1430	Protection settings reset to factory values	If switched off, the control unit will be reset at next reboot to the default values of the protection settings, due to a control unit incident.	Update the MicroLogic X control unit firmware with EcoStruxure Power Commission software. Otherwise, plan to replace the MicroLogic X control unit
0x1442	Contact wear > 100%. Replace CB	The contact wear indicator reached the threshold of 100%.	Replace the circuit breaker. Consult contact wear interpretation on EcoStruxure Power Device app in order to estimate the circuit breaker ability to isolate, withstand rated duty, operate, trip.
0x1444	CB has reached the max number of operations	The circuit breaker reached the maximum number of operations.	Replace the circuit breaker.
0x1446	MicroLogic control unit has reached the max service life	MicroLogic control unit reached 15 years of service life.	Replace the MicroLogic X control unit.
0x1451	MCH has reached the max number of operations	The MCH gear motor reached the maximum number of operations.	Replace the MCH.
0x1453	MX1 voltage release has reached the max number of operations	The MX1 voltage release reached the maximum number of operations.	Replace the MX1 voltage release.
0x1455	XF voltage release has reached the max number of operations	The XF voltage release reached the maximum number of operations.	Replace the XF voltage release.
0x1457	MN undervoltage release has reached the max number of operations	The MN undervoltage release reached the maximum number of operations.	Replace the MN undervoltage release.
0x1459	MX2 voltage release has reached the max number of operations	The MX2 voltage release reached the maximum number of operations.	Replace the MX2 voltage release.
0x150F	Replace Circuit Breaker.	The control unit self test detected the malfunction of all internal current power supply sensors of the circuit breaker.	Replace the circuit breaker.
0x1510	Replace Circuit Breaker. Tsd forced to 0.	The control unit self test detected the malfunction of all internal current power supply sensors of the circuit breaker and Tsd is forced to 0.	Replace the circuit breaker.
0x1511	Plan to Replace Circuit Breaker.	The control unit self test detected the malfunction of one or two internal current power supply sensors of the circuit breaker.	Plan to replace the circuit breaker.
0x1512	Replace Circuit Breaker.	The control unit self test detected the major malfunction of one or two internal current power supply sensors of the circuit breaker.	Replace the circuit breaker.

For more information about the maximum number of operations for individual parts, refer to *DOCA0099EN MasterPact MTZ - IEC Circuit Breakers and Switch-Disconnectors - Maintenance Guide*.

Contact your Schneider Electric field service representative for more information about who can carry out the recommended actions.

Recommended Action After Medium Severity Alarms

The following table indicates what action to perform according to the alarm message.

For more information, refer to the event messages in DOCA0102EN *MasterPact MTZ – MicroLogic X Control Unit – User Guide*.

Code	Alarm message	Alarm description	Recommended action
0x03F5	Ir prealarm (I > 90% Ir)	The long time protection prealarm started: at least one of the phase or neutral currents is above the 90% Ir threshold. The circuit breaker is operating close to Ir threshold.	Check the load.
0x0D00	Critical hardware modules discrepancy	There is a major hardware discrepancy between the installed modules that prevents them from operating.	Check which module is in critical hardware discrepancy with the EcoStruxure Power Commission software Firmware menu. Replace the module.
0x0D01	Critical firmware modules discrepancy	There is a major software discrepancy between the installed ULP modules that prevents them from operating.	Check which module is in critical firmware discrepancy with the EcoStruxure Power Commission software. Update the module.
0x0D02	Non-critical hardware modules discrepancy	There is a minor hardware discrepancy between the installed modules that prevents them from operating correctly.	Check which module is in non-critical hardware discrepancy with the EcoStruxure Power Commission software Firmware menu. Plan to replace the module.
0x0D03	Non-critical firmware modules discrepancy	There is a minor software discrepancy between the installed modules that prevents them from operating correctly.	Check which module is in non-critical firmware discrepancy with the EcoStruxure Power Commission software. Plan to update the module.
0x0D06	Config. error - dual settings or inhibit close order	There is a declaration error between the IO module and the control unit.	Correct the configuration error with EcoStruxure Power Commission software: <ul style="list-style-type: none"> • Dual settings configuration error: <ol style="list-style-type: none"> 1. Set Switch mode to IO - 1 Wire or IO - 2 Wires. 2. Set IO module with dual setting assignment. • Inhibit close order configuration error: <ol style="list-style-type: none"> 1. Set Allow control by digital input under breaker close as enabled. 2. Set IO module with Enable/ Inhibit close order assignment.
0x0D08	Address conflict between modules	The control unit self-test detected the unexpected presence of IO2 module when IO1 is not present.	If two IO modules are installed in the system, make sure one is configured as IO#1, the other as IO#2.
0x0D09	Firmware discrepancy within CU	The control unit self-test detected a discrepancy between the firmware versions of control unit processors.	Check the firmware version of the MicroLogic X control unit with EcoStruxure Power Commission software. If not latest, update the firmware of the MicroLogic X control unit.
0x0D0A	Invalid Control Unit factory config #1	The factory configuration of the control unit is invalid.	Plan to replace the MicroLogic X control unit.
0x0D0C	Config error IO/CU: optional protection Inhibit	There is a declaration error between the IO module and the control unit for inhibition of optional protection functions.	Correct the configuration error with EcoStruxure Power Commission software:

Code	Alarm message	Alarm description	Recommended action
			<ul style="list-style-type: none"> If you want optional protection inhibition to be controlled by IO module, connect an IO module with inhibit optional protection assignment. If you do not want optional protection inhibition to be controlled by IO module, connect an IO module without inhibit optional protection assignment.
0x0D0D	Config. error IO and CU - Local/Remote mode	There is a declaration error between the IO module and the control unit for local/remote mode assignment.	Correct the configuration error with EcoStruxure Power Commission software: <ul style="list-style-type: none"> If you want the L/R mode to be controlled by the IO module, connect an IO module with L/R mode assignment. If you do not want the L/R mode to be controlled by the IO module, connect an IO module without L/R mode assignment.
0x0D0E	Discrepancy between Display and MicroLogic	The control unit self-test detected a discrepancy between the hardware version of the embedded display screen and the firmware version of the control unit.	Replace the embedded display screen.
0x1108	Protection changed by communication	The protection parameters were changed by communication from remote controller, EcoStruxure Power Commission software, or EcoStruxure Power Device app.	No action required, for information only.
0x1120	Communication lost with IO#1 module	The control unit lost communication with the IO1 module.	Check the power supply of the IO1 module. Check the ULP cable connection.
0x1121	Communication lost with IO#2 module	The control unit lost communication with the IO2 module.	Check the power supply of the IO2 module. Check the ULP cable connection.
0x1122	Communication lost with EIFE or IFE module	The control unit lost communication with the EIFE or IFE module.	Check the power supply of the EIFE or IFE module. Check the ULP cable connection.
0x1123	Communication lost with IFM module	The control unit lost communication with the IFM module.	Check the power supply of the IFM module. Check the ULP cable connection.
0x112C	Control unit firmware update unsuccessful	The firmware update of the control unit was unsuccessful.	Restart the update procedure. If the message is displayed again, plan to replace the MicroLogic X control unit.
0x1471 0x1472	Control unit self test	The control unit self-test detected an invalid result with minor impact.	Plan to replace the MicroLogic X control unit.
0x147B	Invalid display screen or wireless communication	The control unit self-test detected an invalid display screen or wireless communication.	Plan to replace the embedded display screen, which contains the wireless antenna.
0x1411	Invalid measurement and optional protection #1	The control unit self-test detected an invalid result with minor impact in the metering and other protection functions of the control unit.	Plan to replace the MicroLogic X control unit.
0x1414 0x1415	NFC invalid communication	The control unit self-test detected an invalid NFC connection.	Plan to replace the embedded display screen, which contains the wireless antenna.
0x1422	Invalid Bluetooth communication	The control unit self-test detected the absence of Bluetooth communication.	Plan to replace the embedded display screen.
0x1433	Replace internal battery	The lithium battery is under 3 V and needs to be replaced soon.	Replace internal battery.
0x1434	Self diagnostic test - firmware	The control unit self-test detected a firmware internal incident.	Update the firmware of the MicroLogic X control unit with EcoStruxure Power Commission software.
0x1438	Main voltage loss and Circuit Breaker is closed	The circuit breaker is closed but no voltage is detected.	Check main voltage on the busbar.
0x1440	Contact wear > 60%. Check contacts	The contact wear indicator reached or is above the threshold of 60%.	Inspect visually the arc chute and main contacts at the next scheduled

Code	Alarm message	Alarm description	Recommended action
			maintenance. Consult contact wear interpretation on EcoStruxure Power Device app in order to estimate the circuit breaker ability to isolate, withstand rated duty, operate, trip.
0x1441	Contact wear > 95%. Plan for replacement	The contact wear indicator reached or is above the threshold of 95%.	Plan to replace the circuit breaker. Consult contact wear interpretation on EcoStruxure Power Device app in order to estimate the circuit breaker ability to isolate, withstand rated duty, operate, trip.
0x1443	Remaining service life of CB is below alarm threshold	The circuit breaker reached 80% of the maximum number of operations.	Plan to replace the circuit breaker. To refine this theoretical alarm by taking in account environmental parameters, you may ask for aging diagnostic. If the device is cloud connected, use EcoStruxure asset advisor for remote aging diagnostic. Otherwise, contact Schneider Electric services for a local aging diagnostic.
0x1445	Remaining service life of MicroLogic is below alarm threshold	The control unit reached 12 years of service life.	Plan to replace the MicroLogic X control unit. To refine this theoretical alarm by taking in account environmental parameters, you may ask for aging diagnostic. If the Device is cloud connected, use EcoStruxure asset advisor for remote aging diagnostic. Otherwise, contact Schneider Electric services for a local aging diagnostic.
0x1450	MCH charging operation counter is above alarm threshold	The MCH gear motor reached 80% of the maximum number of operations.	Plan to replace the MCH. Consult the predicted date of replacement on EcoStruxure Power Device app.
0x1452	MX1 voltage release operation counter is above alarm threshold	The MX1 voltage release reached 80% of the maximum number of operations.	Plan to replace the MX1 voltage release. Consult the predicted date of replacement on EcoStruxure Power Device app.
0x1454	XF voltage release operation counter is above alarm threshold	The XF voltage release reached 80% of the maximum number of operations.	Plan to replace the XF voltage release. Consult the predicted date of replacement on EcoStruxure Power Device app.
0x1456	MN undervoltage release operation counter is above alarm threshold	The MN undervoltage release reached 80% of the maximum number of operations.	Plan to replace the MN undervoltage release. Consult the predicted date of replacement on EcoStruxure Power Device app.
0x1458	MX2 voltage release operation counter is above alarm threshold	The MX2 voltage release reached 80% of the maximum number of operations.	Plan to replace the MX2 voltage release. Consult the predicted date of replacement on EcoStruxure Power Device app.
0x1460	Invalid self test - MX1 voltage release	The control unit self-test of the MX1 voltage release detected an invalid result with minor impact.	Plan to replace the MX1 voltage release.
0x1461	MX1 voltage release not detected	The control unit self-test detected the unexpected absence of the MX1 voltage release.	Check the connection of the MX1 voltage release.
0x1462	Invalid self test - XF voltage release	The control unit self-test of the XF voltage release detected an invalid result with minor impact.	Plan to replace the XF voltage release.
0x1463	XF voltage release not detected	The control unit self-test detected the unexpected absence of the XF voltage release.	Check the connection of the XF voltage release.
0x1464	Invalid self test - MN undervoltage release	The control unit self-test of the MN undervoltage release detected an invalid result with minor impact.	Plan to replace the MN undervoltage release.
0x1465	MN undervoltage release not detected	The control unit self-test detected the unexpected absence of the MN undervoltage release.	Check the connection of the MN undervoltage release.

Code	Alarm message	Alarm description	Recommended action
0x1466	Voltage loss on MN undervoltage release	The circuit breaker opened because there is no control voltage on the MN undervoltage release.	Check the control voltage.
0x1467	Communication loss on MN undervoltage release	The control unit lost communication with the MN undervoltage release.	Check the internal connection of MN undervoltage release.
0x1468	Invalid self test - MX2 voltage release	The control unit self-test of the MX2 voltage release detected an invalid result with minor impact.	Plan to replace the MX2 voltage release.
0x1469	MX2 voltage release not detected	The control unit self-test detected the unexpected absence of the MX2 voltage release.	Check the connection of the MX2 voltage release.
0x140F 0x1474 0x1475 0x1476	Protection settings no accessible	The control unit cannot access the protection settings.	Plan to replace the MicroLogic X control unit.
0x1479	Invalid measurement and optional protection	The control unit self-test detected an invalid measurement or an invalid optional protection function of the control unit.	Plan to replace the MicroLogic X control unit.
0x6200	I_r start (I > 105% I_r)	The long time protection started: at least one of the phase or neutral currents is above the I _r threshold. The circuit breaker will trip at the end of time delay.	No action required, for information only.
0x6300	I_r operate	The long time protection operated: at least one of the phase or neutral currents is above the I _r threshold and the t _r time delay is elapsed.	No action required, for information only.
0x6301	I_{sd} operate	The short time protection operated: at least one of the phase or neutral currents is above the I _{sd} threshold and the t _{sd} time delay is elapsed.	No action required, for information only.
0x6302	I_i operate	The instantaneous protection operated: at least one of the phase or neutral currents is above the I _i threshold (no time delay).	No action required, for information only.
0x050C	I_g alarm	The ground fault alarm operated: the ground fault current is above the I _g alarm threshold and the t _g time delay alarm is elapsed.	Check insulation between phase/neutral and ground (earth).
0x6303	I_g operate	The ground fault protection operated: the ground fault current is above the I _g threshold and the t _g time delay is elapsed.	No action required, for information only.
0x050D	I_{Δn} alarm	The earth leakage alarm operated: the earth leakage current is above the I _{Δn} alarm threshold and the t _{Δn} time delay alarm is elapsed.	Check insulation between phase/neutral and ground (earth).
0x6304	I_{Δn} operate	The earth leakage (I _{Δn}) protection started: the earth leakage current is above the I _{Δn} threshold and the t _{Δn} time delay is elapsed.	No action required, for information only.
0x6310	Undervoltage on 1 phase operate	Undervoltage protection on one phase operated: one of the three monitored voltages is below the V _{min1} threshold.	No action required, for information only.
0x632A	Undervoltage on all 3 phases operate	Undervoltage protection on all three phases operated: the three monitored voltages are below the V _{min2} threshold.	No action required, for information only.
0x6311	Overvoltage on 1 phase operate	Overvoltage protection on one phase operated: one of the three monitored voltages is above the V _{max1} threshold.	No action required, for information only.
0x632B	Overvoltage on all 3 phases operate	Overvoltage protection on all three phases operated: the three monitored voltages are above the V _{max2} threshold.	No action required, for information only.
0x6315	Underfrequency operate	The underfrequency protection operated: the frequency is below the F _{min} threshold.	No action required, for information only.
0x6316	Overfrequency operate	The overfrequency protection operated: the frequency is above the F _{max} threshold.	No action required, for information only.

Code	Alarm message	Alarm description	Recommended action
0x6314	Reverse power operate	The reverse power protection operated: the reverse power is above the Rp threshold and the tRp time delay is elapsed.	No action required, for information only.
0x6321	IDMTL long-time operate	The IDMTL long-time protection operated: at least one of the phase or neutral currents is above the IDMTL Ir threshold and the IDMTL tr time delay is elapsed.	No action required, for information only.
0x6323	Forward directional overcurrent operate	The forward directional overcurrent protection operated: the forward directional overcurrent is above the Ifw threshold and the tfw time delay is elapsed.	No action required, for information only.
0x6324	Reverse directional overcurrent operate	The reverse directional overcurrent protection operated: the reverse directional overcurrent is above the Irv threshold and the trv time delay is elapsed.	No action required, for information only.
0x0C04	ESM (ERMS switch module) self diagnostic alarm	The ESM self-test detected an invalid result with minor impact.	Plan to replace the ESM (ERMS switch module).
0x0C05	Communication lost with ESM (ERMS switch module)	The control unit lost communication with ESM module (ERSM switch module).	Plan to replace the ESM (ERMS switch module).
0x142C	Ig protection configured in OFF mode	The Ig protection (IEC version) is disabled.	No action required, for information only.
0x142F	Last modification of protection settings has not been completely applied	The control unit did not apply the last modification.	Apply again the protection settings.
0x147C	Invalid optional protection self test	The control unit self-test of optional protections detected an invalid result with minor impact.	Plan to replace the MicroLogic X control unit.
0x6306	Ultimate self-protection (SELLIM) operate	The integrated instantaneous protection (SELLIM) operates: at least one of the phase or neutral currents is above the SELLIM threshold (no time delay).	No action required, for information only.
0x631D	Ultimate self-protection (DIN/ DINF) operate	The integrated instantaneous protection (DIN/DINF) operates: at least one of the phase or neutral currents is above the DIN/ DINF threshold (no time delay).	No action required, for information only.
0x1480	Schedule basic maintenance within one month	A basic maintenance program should be performed within one month.	Plan to schedule the basic preventive maintenance program within one month. To plan, edit report and track maintenance intervention, you may use EcoStruxure Facility Expert app.
0x1481	Schedule standard maintenance within one month	A standard maintenance program should be performed within one month.	Plan to schedule the basic preventive maintenance program within one month. To plan, edit report and track maintenance intervention, you may use EcoStruxure Facility Expert app.
0x1482	Schedule manufacturer maintenance within three months	A manufacturer maintenance program should be performed within three months.	Plan to schedule the manufacturer preventive maintenance program within three months. To plan, edit report and track maintenance intervention, you may use EcoStruxure Facility Expert app.

Diagnosing Error Messages

Diagnosis Sequence

The following table shows the sequence of actions to take after an error is detected by the MicroLogic X control unit. Further explanation of each action is given in the following paragraphs.

Step	Action
1	Identify the error detected.
2	Consult the list of error messages, page 125 and perform the actions recommended.
3	Press OK to acknowledge the error and return to the Home menu.
4	Press the Test/Reset button for 3 seconds to reset the latched events.

Identifying the Error Detected

An error message is displayed when the MicroLogic X control unit detects an internal error.

Example of error screen:

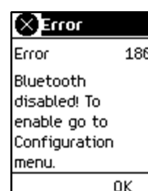

Recommended Action After Detection of Errors

The following table indicates what action to perform according to the error message.

Code	Error message	Error description	Recommended action
1 to 24 157 190	Service not performed - internal error	The requested action has failed due to an internal error	Repeat the action that caused the error. If the message is displayed again, switch off the 24 Vdc of the MicroLogic X control unit and switch it on again. If the problem persists, call Schneider Electric field service.
158	Command rejected, already in progress	The MicroLogic X control unit has detected simultaneous orders (for example between IO and control unit).	Repeat the command.
169	Command rejected, already in asked state.	The MicroLogic X control unit is already in the requested state.	Check that the MicroLogic X control unit is in the required state. If it is not, repeat the command.
174	Session Key is invalid	The request action has failed because the session key is not valid.	Repeat the action that caused the error. If the message is displayed again, switch off the 24 Vdc of the MicroLogic X control unit and switch it on again. If the problem persists, call Schneider Electric field service.
175	Out of session scope	The requested action has failed because it is not within the session scope.	Repeat the action that caused the error. If the message is displayed again, switch off the 24 Vdc of the MicroLogic X control unit and switch it on again. If the problem persists, call Schneider Electric field service.
176	Session is already opened	The MicroLogic X control unit has detected simultaneous settings sessions (for example,	Press OK to clear the message and then repeat the command.

Code	Error message	Error description	Recommended action
		EcoStruxure Power Commission and control unit).	
177	No session is open	Submit/apply operations have not been performed within five minutes.	Start a new session, re-enter the settings, then submit and apply them.
180	Bluetooth disabled! To enable go to Configuration menu.	Bluetooth communication has not been enabled for the MicroLogic X control unit.	Enable Bluetooth communication from the MicroLogic X control unit menu > Configuration > Communication > Bluetooth.

Contact your Schneider Electric field service representative for more information about who can carry out the recommended actions.

MasterPact MTZ Commissioning

What's in This Part

Introduction to Commissioning	128
Inspection and MicroLogic X Settings	130
Tests	132
Communication Tests	136
Final Checks and Reporting	137
MasterPact MTZ Test Form	138

Introduction to Commissioning

Overview

DANGER

HAZARD OF ELECTRIC SHOCK, EXPLOSION, OR ARC FLASH

- Apply appropriate personal protective equipment (PPE) and follow safe electrical work practices. See NFPA 70E, CSA Z462, NOM 029-STPS, or local equivalent.
- This equipment must only be installed and serviced by qualified electrical personnel.
- Unless specified otherwise in the commissioning procedures, all operations (inspection, test, and preventive maintenance) must be carried out with the device, the chassis, and the auxiliary circuits de-energized.
- Check that the device and the chassis are de-energized on the upstream and downstream terminals.
- Always use a properly rated voltage sensing device to confirm that the device, the chassis, and the auxiliary circuits are de-energized.
- Install safety barriers and display a danger sign.
- During the tests, it is strictly forbidden for anyone to touch the device, the chassis, or the conductors while voltage is applied.
- Before putting the equipment back into operation, it is mandatory to check that all connections are made with the correct tightening torque, there are no tools or objects inside the equipment, all devices, doors, and protective covers are in position, and the device is off (open position).

Failure to follow these instructions will result in death or serious injury.

This chapter details the testing and commissioning procedure for MasterPact MTZ devices that must be done before the device can be accepted as fit for service and connected to a power supply.

The commissioning procedure must be done by an authorized commissioning engineer with appropriate training and experience:

- Only qualified electrical personnel with training and experience on low voltage circuits must perform the work described in this chapter.
Personnel must understand the hazards involved in working with or near low-voltage equipment. Such work must be performed only after reading the complete set of instructions.
- Some inspections or procedures require that certain parts of the electrical system remain energized at hazardous voltage during the procedure. Observe all safety messages (Danger, Warning, Caution) throughout this chapter and the corresponding instruction notices.
- Wear personal protective equipment, recognize potential hazards, and take adequate safety precautions when performing the procedures outlined in this chapter and the corresponding instruction notices.

The commissioning procedure assumes that the following conditions are met at the start of the procedure:

- The device is not connected to a power system or a control system.
- A drawout device is in the disconnected position.
- The device is not connected to a communication network.

The results of all observations, tests, adjustments, together with any relevant comments must be recorded on the appropriate form, if applicable.

Wherever possible, testing must be done without disconnecting or disturbing existing wiring.

Scope

The commissioning procedure applies to the MasterPact MTZ intelligent modular unit (IMU), made up of:

- MasterPact MTZ circuit breaker with its MicroLogic X control unit and optional ULP modules:
 - One IFE, EIFE, or IFM communication interface
 - One or two IO modules
 - One FDM121 display
- MasterPact MTZ switch-disconnector

The associated information, which must be read with this procedure, includes specific schematic diagrams, connections, and trip levels for the devices covered by this document.

Equipment

The following equipment is required to do the tests detailed in the commissioning procedure:

- Insulation resistance tester
- Multimeter
- A PC equipped with the latest version of EcoStruxure Power Commission software
- A USB to mini USB cable (LV850067SP) to connect the PC to the MicroLogic X control unit

Test Form

A test form, page 138 is proposed to guide you through the commissioning procedure and to record the results of the commissioning tests. Each test is described in detail in the Commissioning chapter.

Only do the tests required, depending on the MasterPact MTZ type and the functions in use.

Inspection and MicroLogic X Settings

Visual Inspection

Step	Action
1	Record the equipment identification, including substation name, switchboard name, MasterPact MTZ device type, MicroLogic X model type and serial number, MicroLogic X type, and protection settings.
2	Check that the device is undamaged, correctly mounted, and securely fastened in the switchboard.
3	Check the 3-phase clearance at terminal blocks.
4	Check that there is no debris remaining at the back of the device housing/enclosure.
5	Check that the ground terminals of the device are securely connected with the correct grounding cables.
6	Check that all external surfaces are undamaged.
7	Rectify any non-conformities, if possible. All equipment non-conformities must be referred to asset management.

Condition of Connections and Auxiliaries

Check device mounting in the switchboard and the tightness of all connections (main connection and auxiliary wiring).

Check that all auxiliaries and accessories are correctly installed:

- Electrical auxiliaries
- Terminal blocks
- Connections of auxiliary circuits

Check Firmware Compatibility

By using the latest version of EcoStruxure Power Commission software, check that the firmware of the MicroLogic X control unit and ULP modules in the intelligent modular unit (IMU) are up-to-date, compatible with each other, and are compatible with the Digital Modules that are installed. The ULP modules are EIFE, IFE, or IFM communication interfaces, IO module, and FDM121 display.

Step	Action
1	Connect a PC running EcoStruxure Power Commission software by using a cable connected to the mini USB port on the front face of the MicroLogic X control unit.
2	Establish a connection. EcoStruxure Power Commission software reads the parameters of the control unit.
3	<p>On EcoStruxure Power Commission, use the Overall System firmware status/compatibility matrix to display:</p> <ul style="list-style-type: none"> • The installed firmware version of the IMU devices (MicroLogic X control unit and ULP modules). • The latest firmware version of the devices that are available on the Schneider Electric System Updates Internet site. • The recommended actions to get a compatible system. <p>For more information, refer to <i>EcoStruxure Power Commission Online Help</i>.</p> <p>NOTE: The FDM121 display firmware version must be 004.000.009 or greater to be compatible with MicroLogic X control units. Earlier firmware versions need to be updated, refer to <i>Troubleshooting</i>, page 154.</p>
4	Follow the recommended actions to get a compatible system.

MicroLogic X Settings

NOTICE	
RISK OF UNINTENDED OPERATION	
<ul style="list-style-type: none"> • The device must only be configured and set by qualified personnel, using the results of the installation protection system study. • During commissioning of the installation and following any modification, check that the MicroLogic X configuration and protection function settings are consistent with the results of this study. • MicroLogic X protection functions are set by default to the minimum value, except for the long time protection function which is set to the maximum value, by default. 	
Failure to follow these instructions can result in equipment damage.	

Check the settings with EcoStruxure Power Commission software connected to the MicroLogic X control unit.

Step	Action
1	Connect a PC running EcoStruxure Power Commission software by using a cable connected to the mini USB port on the front face of the MicroLogic X control unit.
2	Establish a connection. EcoStruxure Power Commission software reads the parameters of the control unit.
3	Check that the settings read in the control unit match the requirements of the application. If necessary, correct the settings with EcoStruxure Power Commission software: <ul style="list-style-type: none"> • The protection settings must be defined according to the installation protection system study. • Other settings must be defined according to the application.
4	Complete the project and device data.
5	Generate the project report with EcoStruxure Power Commission software, and save or print the project report as needed.

NOTE: The protection functions available depend on the type of MicroLogic X control unit and its associated optional Digital Modules.

Tests

Overview

The tests to do while commissioning an MTZ device are described in this section:

- Functional checks
- Check of MCH gear motor (if fitted)
- Check of M2C programmable contacts and IO module (if fitted)
- Check of ESM ERMS switch module (if fitted)
- Check of electrical continuity
- Check of high-voltage insulation
- Check of MicroLogic X **Ready** LED status
- Test of the tripping mechanism with EcoStruxure Power Commission software
- Test of the tripping mechanism with the test button (MicroLogic 6.0 X or 7.0 X control units)
- Automatic trip curve test with EcoStruxure Power Commission software

Only do the tests required, depending on the MasterPact MTZ type and the functions in use, and record the results on the [test form](#), page 138. In the event of non-conformance, the result must be recorded and the MasterPact MTZ device must not be accepted into service.

Functional Checks

Follow this procedure to check the operation of the MasterPact MTZ device and record the results on the test form.

Step	Action
1	Manually charge the mechanism by pulling the spring charging handle down.
2	Close the device. Check the closing of the device in each of the different control modes and means designed for the application.
3	Open the device. Check the opening of the device in each of the different control modes and means designed for the application.

If the device does not close or does not open, refer to [Troubleshooting](#), page 142.

Check of MCH Gear Motor (if Fitted)

Follow this procedure to check the operation of the MCH gear motor and record the results on the test form.

Step	Action
1	Remove the MCH gear motor power supply.
2	Do an opening/closing/opening cycle to discharge the mechanism.
3	With the device in the open position and the mechanism discharged, check electrical continuity between terminals B1 and B2, and electrical non-continuity between terminals B1 and B3.
4	Manually charge the mechanism.
5	Reconnect the MCH gear motor power supply. The device closes and the mechanism is automatically charged.
6	Check electrical continuity between terminals B1 and B3.
7	Operate the device several times to check that the spring mechanism automatically recharges after every closing operation.

Check of M2C Programmable Contacts and IO Module (if Fitted)

Follow this procedure to check the operation of inputs and outputs, and record the results on the test form.

Step	Action
1	Connect a PC running EcoStruxure Power Commission software by using a cable to the mini USB port on the front face of the MicroLogic X control unit.
2	Force the state of both inputs of the M2C programmable contacts and check that the operation is correct.
3	Force the state of the six digital inputs and three outputs of the one or two IO modules in the IMU to check the wiring to the circuit breaker. Check that the operation is correct.

Check of ESM ERMS Switch Module (if Fitted)

Follow this procedure to check the operation of the ESM ERMS switch module, and record the results on the test form.

Step	Action
1	Make sure that the MicroLogic X control unit is powered permanently with a 24 Vdc power supply.
2	Connect the ESM ERMS switch module to an external switch with a 24 Vdc or 24—120 Vac power supply.
3	Activate the ERMS function by moving the external switch to the Engage position. Check that: <ul style="list-style-type: none"> The ERMS LED on the front face of the MicroLogic X control unit lights blue. The MicroLogic X control unit display screen is lit with a blue backlight. The message ERMS Engaged is displayed on the MicroLogic X control unit display screen.
4	Disengage the ERMS function by moving the external switch to the Disengage position, and check after 3 s that the MicroLogic X control unit returns to its original state.

Check of Electrical Continuity

Follow this procedure to check electrical continuity using a multimeter or continuity checker and record the results on the test form.

Step	Action
1	Close the device.
2	Check electrical continuity, for each of the phases, between the upper and lower power terminals: <ul style="list-style-type: none"> For fixed device: on the power terminals For the drawout device: on the chassis power terminals, with the device in the connected position

Check of High-Voltage Insulation

Dielectric tests (high potential and insulation resistance tests) are used to check the insulation between phases, and insulation between each phase and ground. The equipment used to conduct these tests creates a high potential voltage (thousands of volts) to check dielectric or insulation integrity.

If included in the MicroLogic X control unit, the voltage power supply (VPS) module connects and disconnects the control unit with the voltage connections in the circuit breaker.

Before conducting any high-voltage insulation tests, move the VPS module to the disconnected position and unplug any cables from the mini USB port on the front

face of the MicroLogic X control unit. For information on VPS disconnection, consult the instruction sheet on the Schneider Electric website: NVE40741.

⚠ CAUTION
DETERIORATION OF VPS MODULE
Disconnect the VPS module by pulling it out to the disconnected position before running a dielectric test on the equipment.
Failure to follow these instructions can result in injury or equipment damage.

Follow this procedure to check insulation resistance and record the results on the test form.

Step	Action
1	Disconnect the VPS module and unplug any cables from the mini USB port on the front face of the MicroLogic X control unit.
2	Close the MasterPact MTZ device.
3	Measure the insulation resistance using a 500 Vdc insulation resistance tester between one of the phases and the other two phases grounded. Repeat for each phase.
4	Open the MasterPact MTZ device by pressing the opening pushbutton.
5	Measure the insulation resistance using a 500 Vdc insulation resistance tester between one of the phases and ground, with all other phases grounded. Repeat for each phase.
6	Check that the insulation resistance is above 5 MΩ in each case. If this result is not obtained, contact your field service representative.

Check of MicroLogic X Ready LED Status

Follow this procedure to check the functioning of the MicroLogic X control unit and record the results on the test form.

Step	Action
1	Provide power to the MicroLogic X control unit, for example, by connecting a PC or Mobile Power Pack to the mini USB port on the front face.
2	Check that the MicroLogic X Ready LED is flashing green. The Ready LED flashes green to indicate that: <ul style="list-style-type: none"> • The sensors are correctly wired. • The tripping mechanism is functioning correctly. • The MicroLogic X control unit is functioning correctly.
3	If the Ready LED is not flashing green, refer to chapter Critical Cases, page 108.

Test of the Tripping Mechanism With EcoStruxure Power Commission Software

Follow this procedure to test the tripping mechanism of the circuit breaker and record the results on the test form.

Step	Action
1	Close the circuit breaker.
2	Connect a PC running EcoStruxure Power Commission software by using a cable to the mini USB port on the front face of the MicroLogic X control unit.
3	On EcoStruxure Power Commission software, select the circuit breaker and connect to it.
4	Force the circuit breaker to trip by clicking the Force Trip button on the EcoStruxure Power Commission screen. This action is password-protected.

Step	Action
5	Check that the circuit breaker is open.
6	Check that the blue fault-trip reset button has popped out.
7	Check that the Isd/Ii LED is on.
8	Check that the SDE contacts have switched.
9	After the test, reset the circuit breaker.

Test of the Tripping Mechanism with the Test Button (MicroLogic 6.0 X and 7.0 X Control Units)

Follow this procedure to test the tripping mechanism of the circuit breaker when fitted with a MicroLogic 6.0 X or 7.0 X control unit, and record the results on the test form.

Step	Action
1	Close the circuit breaker.
2	Use a thin screwdriver to briefly push in (<1 s) the test button on the control unit.
3	Check that the circuit breaker is open.
4	Check that the blue fault-trip reset button has popped out.
5	Check that the Ig/IΔn LED is on.
6	Check that the SDE contacts have switched.
7	After the test, reset the circuit breaker.

Automatic Trip Curve Test With EcoStruxure Power Commission Software

Follow this procedure to run the automatic trip curve test and record the results on the test form.

Step	Action
1	Close the circuit breaker.
2	If the device is equipped with an MN undervoltage release, either connect it to the power supply with its rated voltage or remove the MN undervoltage release.
3	Connect a PC running EcoStruxure Power Commission software by using a cable to the mini USB port on the front face of the MicroLogic X control unit.
4	On EcoStruxure Power Commission software, select the circuit breaker and connect to it.
5	In the Device Check up section, click the Device tab.
6	Select the Automatic Trip Test section.
7	Select Preconfigured test point .
8	Select the overcurrent protection to be tested.
9	Click Run Test .
10	Check that the circuit breaker trips.
11	Check that the blue fault-trip reset button has popped out
12	Check that the related trip cause LED is lit.
13	Check the SDE contacts have switched.
14	After the test, reset the circuit breaker.

Communication Tests

Communication Network Test

EcoStruxure Power Commission software can be used to test the communication network between all the communicating devices of the project:

- Circuit breakers connected to the Ethernet network through an IFE or EIFE Ethernet interface.
- Circuit breakers connected to a Modbus serial line network through an IFM interface stacked to an IFE Ethernet server.
- Circuit breakers connected to a Modbus serial line network from an IFM interface.

Step	Action
1	Connect a PC running EcoStruxure Power Commission software by using an RJ45 cable to a communication network, on the IFE or EIFE Ethernet interface, or IFM interface, for example.
2	In EcoStruxure Power Commission software, at Create report > Communication test & report , select devices to be tested from the list of communicating devices defined in the project.
3	Click Run test . All selected devices are tested.
4	Results are displayed at the end of the test.
5	Generate the communication test report with EcoStruxure Power Commission software, and save or print the project report as needed.

Remote Control Tests

If the MasterPact MTZ circuit breakers can be opened and closed remotely through the communication network, use the following tests to check for the correct operation of remote control:

Step	Action
1	Connect a PC running EcoStruxure Power Commission software by using an RJ45 cable to a communication network, on the IFE or EIFE Ethernet interface, or IFM interface, for example.
2	Check that the control mode is set to Auto: Remote.
3	In EcoStruxure Power Commission software, select the circuit breaker and connect to it.
4	Click the Device tab to access the Open and Close buttons.
5	Check that it is possible to open and close the MasterPact MTZ device remotely. These actions are password-protected.

Final Checks and Reporting

Final Checks

After completing the commissioning tests, check the following:

Step	Action
1	Check that connections are made with the correct tightening torque, that there are no tools or objects inside the equipment, and that all devices, doors, and protective covers are in position.
2	Check that the device is off (open position) and the closing spring is charged.

Project Report Generated by EcoStruxure Power Commission Software

EcoStruxure Power Commission software generates a project report with a list of the circuit breakers for that project. For each MasterPact MTZ circuit breaker it provides the following information:

- The circuit breaker identification data
- The MicroLogic X identification data, including the list of Digital Modules installed
- The list of accessories including internal accessories (for example, M2C programmable contacts), and external modules (for example, IO module)
- The protection settings for the MicroLogic X control unit
- The alarm settings
- The IFE, EIFE, or IFM communication interface settings

Communication Test Report Generated by EcoStruxure Power Commission Software

EcoStruxure Power Commission software performs a communication test and generates a report of the test. For each communicating device it provides the following information:

- The name and type of the device
- The type of communication
- The address of the device
- The status of the connection

MasterPact MTZ Test Form

How to Use the Test Form

Print this test form to record the results of the commissioning tests.

Check the box (✓) when the test has been made and is conclusive.

This test form, the project report, and the communication test report should be left on-site in a plastic wallet and in an easily accessible, safe place.

Each test is described in detail in the Commissioning chapter.

Only do the tests required, depending on the MasterPact MTZ type and the functions in use.

When all the tests have been satisfactorily completed, sign and date the test form.

Identification

Workstation		Tests conducted on:	By:
			Signature:
Substation name		Comments:	
Substation number			
Switchboard name			
Voltage			
MasterPact MTZ device			
Manufacturer	Schneider Electric		
Type of MasterPact MTZ device			
Serial number			
Hardware version			
MicroLogic X control unit			
MicroLogic X type		CT ratio	
Firmware version			

Preliminary Checks

Type of check	(✓)
Visual inspection satisfactory (for example, no visible signs of damage).	
Grounding satisfactory.	
Connection tightness checked.	
Firmware compatibility satisfactory.	
MicroLogic X settings applied.	
Project report generated.	

Functional and Interlock Checks

Type of check	(✓)
Mechanism charges when spring charging handle is pulled.	
MasterPact MTZ device closes.	
MasterPact MTZ device opens.	
Mechanism charges automatically after closing when the device is fitted with an MCH gear motor.	
M2C programmable contacts function correctly.	
IO module functions correctly.	
FDM121 display functions correctly.	
ESM ERMS switch module functions correctly.	
Interlocking systems of the circuit breaker function correctly.	
Interlocking systems between two or three circuit breakers function correctly.	

Electrical Continuity Check

MasterPact MTZ device status	Tested terminals		Electrical continuity
	Incoming side	Outgoing side	
Closed	L1	L1	Ω
Closed	L2	L2	Ω
Closed	L3	L3	Ω

MasterPact MTZ Insulation Test

MasterPact MTZ device status	Terminals under test	Voltage	Insulation resistance
Closed	L1, with L2 and L3 grounded	500 Vdc	MΩ
Closed	L2, with L1 and L3 grounded	500 Vdc	MΩ
Closed	L3, with L1 and L2 grounded	500 Vdc	MΩ
Open	L1, with L1, L2, L3 grounded on the other side	500 Vdc	MΩ
Open	L2, with L1, L2, L3 grounded on the other side	500 Vdc	MΩ
Open	L3, with L1, L2, L3 grounded on the other side	500 Vdc	MΩ

Check of MicroLogic X Ready LED

Type of check	(✓)
MicroLogic X Ready LED flashes green.	

Test of the Tripping Mechanism for MicroLogic X Control Units

Type of check	(✓)
With the circuit breaker closed, force the circuit breaker to trip using EcoStruxure Power Commission software.	
Check that the circuit breaker is open.	
Check that the blue fault-trip reset button has popped out.	
Check that the lsd/li LED is on.	
Check that the SDE contacts have switched.	

Test of the Tripping Mechanism for MicroLogic 6.0 X and 7.0 X Control Units

Type of check	(✓)
With the circuit breaker closed, briefly press (<1 s) the test button on the front face of the control unit.	
Check that the circuit breaker is open.	
Check that the blue fault-trip reset button has popped out.	
Check that the Ig/IΔn LED is on.	
Check that the SDE contacts have switched.	

Automatic Trip Curve Test

Type of check	(✓)
Check that the circuit breaker trips.	
Check that the blue fault-trip reset button has popped out.	
Check that the related trip cause LED is on.	
Check that the SDE contacts have switched.	

Communication Tests

Type of check	(✓)
Communication network tested.	
Communication test report generated.	
Remote opening and closing tested.	

Final Checks

Type of check	(✓)
All doors and protected covers are in position.	
The device is off (open position) and the closing spring is charged.	

MasterPact MTZ Troubleshooting

What's in This Part

Introduction to Troubleshooting	142
Troubleshooting: Chassis Operation	145
Troubleshooting: Unexpected Tripping	146
Troubleshooting: Mechanical Control Operations	147
Troubleshooting: Electrical Control Operations	148
Troubleshooting: Control Operations from EcoStruxure Power Device App	150
Troubleshooting: Control Operations from IO Module	152
Troubleshooting: Control Operations from FDM121 Display	154
Troubleshooting: Control Operations from EcoStruxure Power Commission Software	156
Troubleshooting: Control Operations from IFE/EIFE Webpages	158
Troubleshooting: Control Operations from Communication Network	160
Troubleshooting: Control Operations from FDM128 Display	162

Introduction to Troubleshooting

Presentation

This chapter contains information for troubleshooting problems in a working system. It assumes that the system is correctly installed and that all the commissioning tests have been completed successfully. The troubleshooting operations are described under the following headings:

- Chassis operation
- Unexpected tripping
- Mechanical control operations
- Electrical control operations
- Control operations from EcoStruxure Power Device app
- Control operations from IO module
- Control operations from EcoStruxure Power Commission software
- Control operations from IFE/EIFE webpages
- Control operations from communication network
- Control operations from FDM128 display

Layer Model

When troubleshooting the device, it is useful to consider a layer model. There are four layers:

- Communication network
- Direct connection
- Electrical
- Mechanical

The following diagram shows the layers in the device:

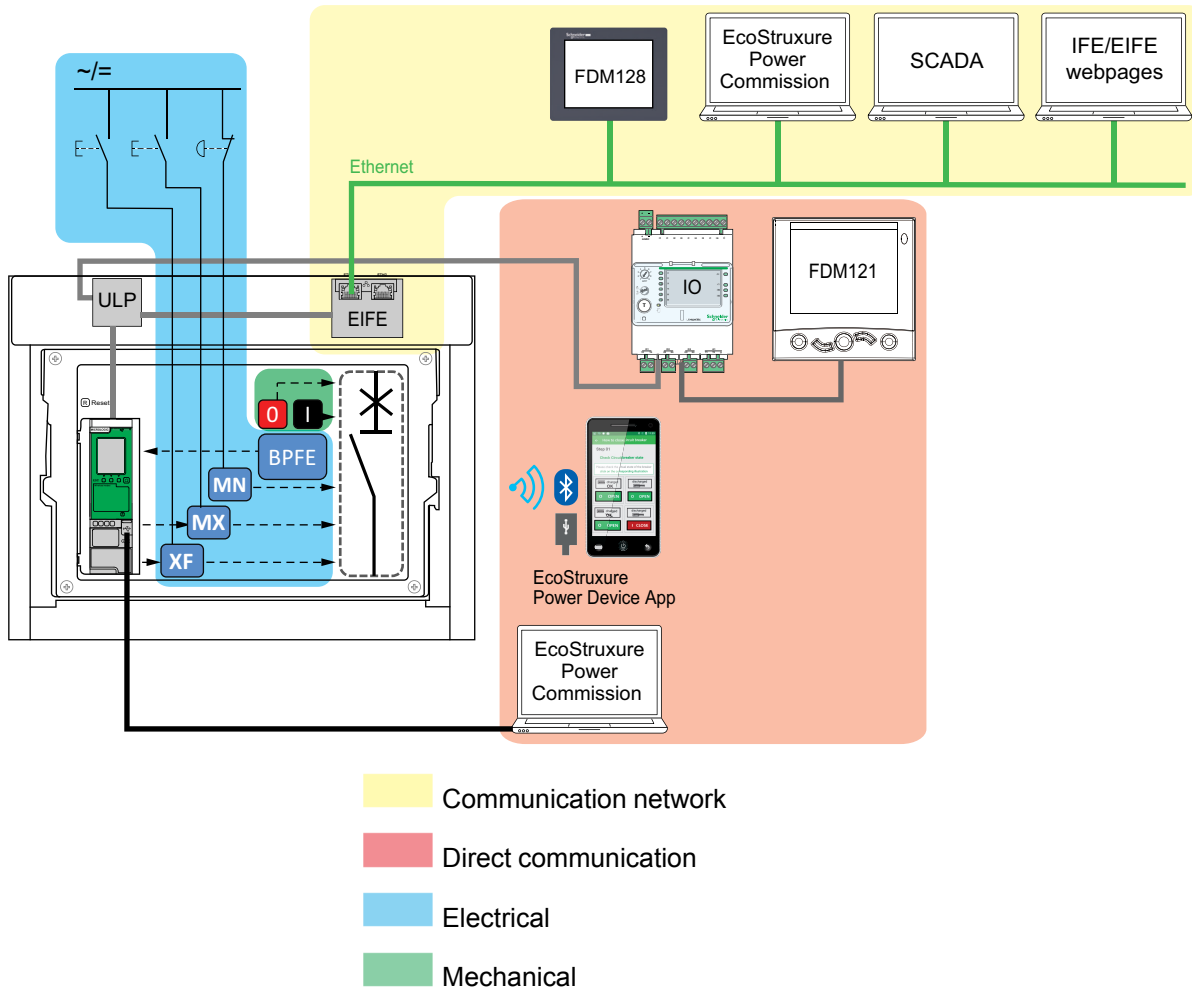

If the troubleshooting actions for a layer are not successful, go to the next layer until you reach the Mechanical layer. If you cannot solve the problem after troubleshooting the Mechanical layer, contact your field service representative.

Troubleshooting with Assistance

Assistance for troubleshooting is provided by the MasterPact Operation Assistant Digital Module.

The MasterPact Operation Assistant Digital Module helps to close a circuit breaker after a trip or an opening.

The following features are available:

- Ready-to-close status
- Reset (if applicable)
- Spring charging (if applicable)
- Diagnostics on related reclosing information, for example, no power supply to MX opening voltage release, MN undervoltage release, or MCH gear motor

Refer to DOCA0102EN *MasterPact MTZ – MicroLogic X Control Unit – User Guide* for more information about downloading Digital Modules.

Maintenance of the Device

Schneider Electric recommends a preventive maintenance program to ensure that devices retain the operating and technical characteristics specified in the catalogs during their service life. Maintenance must be carried out by trained and qualified personnel.

For information about the preventive maintenance program and maintenance procedures, refer to DOCA0099EN *MasterPact MTZ - IEC Circuit Breakers and Switch-Disconnectors - Maintenance Guide*.

Troubleshooting: Chassis Operation

Definition

Chassis operation includes the following:

- Racking in and racking out the drawout device
- Locking and unlocking the chassis

Troubleshooting

Problem description	Probable causes	Solutions
Impossible to insert the racking handle in connected, test, or disconnected position.	A padlock or keylock is present on the chassis or a door interlock is present.	Disable the locking function.
Impossible to turn the racking handle.	The position release button is not pushed in and so the racking handle cannot be rotated.	Push the position release button.
Device cannot be removed from chassis.	Device is not in the disconnected position.	Turn the racking handle until the device is in the disconnected position and the position release button pops out.
	Rails are not completely extended.	Pull out the rails of the chassis.
Device cannot be connected (racked in).	Chassis and device do not match (mismatch protection).	Check that the chassis corresponds with the device.
	Safety shutters are locked.	Remove the locks.
	Disconnecting contact clusters are incorrectly positioned.	Reposition the disconnecting contact clusters.
	Chassis is locked in the disconnected position.	Disable the chassis locking function.
	The position release button is not pushed in and so the racking handle cannot be rotated.	Push the position release button.
	Device has not been sufficiently inserted in the chassis.	Insert the device completely so that it is engaged in the racking mechanism.
Device cannot be locked in the disconnected position.	Device is not in the correct position.	Check the device position by checking that the position release button is popped out.
	Racking handle is still in the chassis.	Remove the racking handle and store it.
Device cannot be locked in the connected, test, or disconnected position.	Locking in any position is not enabled.	Adapt the chassis locking mechanism so that the chassis can be locked in any position.
	Device is not in the correct position.	Check the device position by checking that the position release button is out.
	Racking handle is still in the chassis.	Remove the racking handle and store it.
The racking handle cannot be inserted to connect or disconnected the device.	Rails are not completely in.	Push the rails all the way in.
The right-hand rail (chassis alone) or the device cannot be drawn out.	Racking handle is still in the chassis.	Remove the racking handle and store it.

Troubleshooting: Unexpected Tripping

Definition

Unexpected tripping is tripping that is not caused by a protection function during normal operation or by tests.

Troubleshooting



Problem description	Symptom	Probable causes	Solutions
Device opened without any over-current electrical fault.	The blue fault-trip reset button is not popped out and no trip cause LED is lit.	Drop in voltage to below the threshold detected by MN undervoltage release.	Check the voltage and the MN supply circuit ($V > 0.85 U_n$).
		An order (for example load-shedding) sent to the MX opening voltage release by another device.	Check the parameters of the device that sent the order.
		Unnecessary opening order from the MX opening voltage release.	Determine the origin of the order and cancel it.
Device trips in a shorter time than expected after attempt to close the device.	The blue fault-trip reset button is popped out and the Ir LED is lit.	Thermal memory is still active and current on the line is above the Ir threshold.	Check whether there is still an overload on the line. If necessary, make a correction. For details of thermal memory, refer to DOCA0102EN <i>MasterPact MTZ – MicroLogic X Control Unit – User Guide</i> .
	The blue fault-trip reset button is popped out, the Ir or Isd LED is lit, and the ERMS LED is lit.	ERMS is active so device opens at lower protection settings.	The ERMS function applies reduced protection settings for use during maintenance. Check whether maintenance is in progress. If ERMS is no longer necessary, disengage it to revert to normal protection settings.
	–	The tripping curves (A or B) have been modified, or the control unit is not set to the usual set of tripping curves (A or B).	This might be a change in intended behavior so not a problem. Check the tripping curve definitions are describing the intended behavior. Modify the definitions if necessary.
Immediate tripping after an attempt to close the device.	The blue fault-trip reset button is popped out and the Ir LED is lit.	Transient overcurrent when closing.	<ul style="list-style-type: none"> Modify the distribution system or the control unit settings. Check the condition of the device before putting it back into service.
Immediate tripping after an attempt to close the device with activation of the blue fault-trip reset button.	–	Closing on a short-circuit.	Refer to MasterPact MTZ critical cases.
Nuisance tripping of the device with activation of the blue fault-trip reset button.	–	Blue fault-trip reset button is not pushed-in completely.	Push in the blue fault-trip reset button completely.
	–	Transient overcurrent detected on the line and fast instantaneous trip setting is active in EcoStruxure Power Commission software.	Intended behavior. If necessary, adjust the settings in EcoStruxure Power Commission software.

Troubleshooting: Mechanical Control Operations

Definition

Mechanical control operations are operations that are made using the opening or closing pushbuttons.

Device Cannot be Closed by Using the Mechanical Closing Pushbutton

Symptom	Probable causes	Solutions
The blue fault-trip reset button is popped out.	The blue fault-trip reset button has not been reset.	<ul style="list-style-type: none"> Clear the fault. Push the blue fault-trip reset button.
–	Device is padlocked or keylocked in the open position.	Unlock the device.
–	Device is interlocked mechanically in a mechanical interlocking system.	<ul style="list-style-type: none"> Check the position of the other device in the changeover system. Modify the situation to release the interlock.
The closing spring and ready-to-close indicator shows that the mechanism is discharged. 	Stored energy mechanism is not charged.	<ul style="list-style-type: none"> Charge the mechanism manually. If the device is equipped with an MCH gear motor, check the supply of power to the motor. If the problem persists, replace the MCH gear motor.
The closing spring and ready-to-close indicator shows that the mechanism is charged but the device is not ready to close. 	MX opening voltage release is permanently powered.	As there is an opening order, determine the origin of the order. The order must be canceled before the device can be closed.
	MN undervoltage release is not powered due to an opening order.	As there is an opening order, determine the origin of the order. The order must be canceled before the device can be closed.
	MN undervoltage release is not powered due to insufficient voltage power supply.	Check the voltage and the MN supply circuit ($V > 0.85 U_n$). If the problem persists, replace the MN undervoltage release.
Recurring undervoltage trip.	The measured voltage remains at 0 V.	Set the undervoltage behavior parameter, Vmin behavior, to Force to Off when CB is open . For more information, refer to DOCA0102EN <i>MasterPact MTZ – MicroLogic X Control Unit – User Guide</i> .
The position release button on the chassis of the drawout device is pushed in.	Device is not correctly connected.	Terminate racking in (connection) of the device, making sure that it is fully inserted in the chassis, to the connected position. Check that the position release button is popped out.

Device Cannot be Opened by Using the Mechanical Opening Pushbutton

Probable causes	Solutions
Operating mechanism incident or welded contacts.	Contact your field service representative.

Troubleshooting: Electrical Control Operations

Definition

Electrical control operations are operations that are made by an electrical order through a voltage release or by an external pushbutton that is directly connected to a voltage release.

Troubleshooting Voltage Releases

Troubleshooting depends on the type of voltage release, as follows:

- For communicating voltage releases, consult the MicroLogic X event messages and then refer to MasterPact MTZ Critical Cases
- For standard voltage releases, follow the troubleshooting instructions given in the following tables. If the problem persists, replace the voltage release.

Device Cannot be Closed by Using an External Pushbutton/Electrical Order

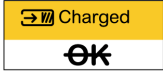
Symptom	Probable causes	Solutions
–	Device is padlocked or keylocked in the open position.	Unlock the device.
–	Electrical closing order not executed by the XF closing voltage release due to insufficient voltage power supply.	Check the voltage and the XF supply circuit (0.85–1.1 Un). If the problem persists, replace the XF closing voltage release.
The closing spring and ready-to-close indicator shows that the mechanism is charged but the device is not ready to close. 	MX opening voltage release is permanently powered.	As there is an opening order, determine the origin of the order. The order must be canceled before the device can be closed.
	MN undervoltage release is not powered due to an opening order.	As there is an opening order, determine the origin of the order. The order must be canceled before the device can be closed.
	MN undervoltage release is not powered due to insufficient voltage power supply.	Check the voltage and the MN supply circuit ($V > 0.85 U_n$). If the problem persists, replace the MN undervoltage release.
–	XF closing voltage release is continuously supplied, but device was not ready-to-close when the closing order was sent (XF closing voltage release is not wired in series with PF ready-to-close contact).	<ul style="list-style-type: none"> • Remove the power supply to the XF closing voltage release. • Only if the device is ready-to-close, send the closing order again via the XF closing voltage release.

Device Cannot be Opened by Using an External Pushbutton/Electrical Order

Probable causes	Solutions
Opening order is not executed by the MN undervoltage release.	Drop in voltage insufficient or residual voltage ($V > 0.35 U_n$) across the terminals of the MN undervoltage release. If the problem persists, replace the MN undervoltage release.
Opening order is not executed by the MX opening voltage release.	Check the voltage and the MX supply circuit ($0.7-1.1 U_n$). If the problem persists, replace the MX opening voltage release.

Device Cannot be Reset by Using RES Electrical Remote Reset

Symptom	Probable causes	Solutions
The blue fault-trip reset button is popped out.	Insufficient supply voltage for the RES electrical remote reset.	Check the voltage and the RES supply circuit ($0.7-1.1 U_n$). If the problem persists, replace the RES electrical remote reset.

Additional Checks

If the troubleshooting actions described above do not work, refer to the troubleshooting information for [Mechanical Control Operations](#), page 147.

Troubleshooting: Control Operations from EcoStruxure Power Device App

Definition

Control operations include commands to open and close the device from the EcoStruxure Power Device app.

Device Cannot be Controlled from the EcoStruxure Power Device App

Problem description	Symptom	Probable causes	Solutions
Device cannot be opened or closed.	–	The device control mode is set to Manual.	Change the control mode to Auto.
	–	The device control mode is set to Auto Remote.	Change the control mode to Auto Local.
	The EcoStruxure Power Device app displays a message to download the MasterPact Operation Assistant Digital Module.	The MasterPact Operation Assistant Digital Module is not installed.	Use EcoStruxure Power Commission software to download and install the MasterPact Operation Assistant Digital Module in the MicroLogic X control unit.
	The EcoStruxure Power Device app displays a message indicating a firmware version mismatch.	The EcoStruxure Power Device app on the smartphone is not compatible with the firmware version of the MicroLogic X control unit.	Update the EcoStruxure Power Device app.
Device cannot be closed.	–	The close command is inhibited by the IO module.	Enable the close command by using the selector switch wired on a digital input of the IO module (I=1).
		The close command is inhibited by a command from the communication network or EcoStruxure Power Commission software.	In EcoStruxure Power Commission software, in the Device Check-up > Devices menu, change the value of the Remote Close Breaker Inhibited parameter from Enabled by communication to Disabled .

Inhibit Closing by IO Module is Not Operational

Problem description	Probable cause	Solution
Device can be closed while selector switch wired on a digital input of the IO module is set to Inhibit (I4=0).	The MicroLogic X setting Breaker closing by digital input is disabled.	In EcoStruxure Power Commission software, in the General menu, in Breaker Closing Inhibition , change the value of the Allow control by a digital input parameter to Enable .

Device Cannot be Controlled from the EcoStruxure Power Device App Connected Through Bluetooth

Problem description	Probable causes	Solutions
The Bluetooth LED does not light up when you press the Bluetooth activation pushbutton on the MicroLogic X control unit.	The Bluetooth function is not enabled in the MicroLogic X control unit.	Enable Bluetooth communication in the MicroLogic X control unit.
	The MicroLogic X control unit is not powered.	Check the power supply of the MicroLogic X control unit.
The Bluetooth connection was established but the signal is lost.	The smartphone has been moved out of range.	Place the smartphone within the range for Bluetooth and establish a new connection.
The Bluetooth LED is blinking on the control unit but you cannot see its ID number in the list of devices available.	A smartphone is already connected to the MicroLogic X control unit.	Check whether another smartphone within range is also connected to the control unit.

Additional Checks

If the troubleshooting actions described above do not work, the problem might be in the mechanical or electrical operations of the device. Refer to the troubleshooting information for Mechanical Control Operations, page 147 and Electrical Control Operations, page 148.

Troubleshooting: Control Operations from IO Module

Definition

Control operations include commands to open and close the device from the IO module with the Breaker Operation predefined application.

For information about control operations from the IO module, refer to DOCA0055EN *Enerlin'X IO – Input/Output Application Module for One IEC Circuit Breaker – User Guide*.

Device Cannot be Controlled from the IO Module

Problem description	Symptom	Probable causes	Solutions
Device cannot be opened or closed.	–	The IO module is not configured for Breaker Operation predefined application 2.	Configure the IO module for Breaker Operation predefined application 2, by using the rotary switch and pressing the Test/Reset button for 5 seconds to validate the configuration.
	–	The device control mode is set to Manual.	Change the control mode to Auto.
	Local open or close orders wired on digital inputs I5 or I6 do not control the device.	The device control mode is set to Remote.	Change the control mode to Local by using the control mode selector switch wired on the digital input I1 of the IO module (I1=0).
	Remote open or close orders wired on digital inputs I2 or I3 do not control the device.	The device control mode is set to Local.	Change the control mode to Remote by using the control mode selector switch wired on the digital input I1 of the IO module (I1=1).
Device cannot be closed.	–	The close command is inhibited by the IO module configured in the Breaker Operation predefined application 2.	Enable the close command by using the selector switch wired on the digital input I4 of the IO module (I4=1).
	–	The close command is inhibited by a command from the communication network or EcoStruxure Power Commission software.	In EcoStruxure Power Commission software, in the Device Check-up > Devices menu, change the value of the Remote Close Breaker Inhibited Enabled by communication parameter from Enabled to Disabled .

Inhibit Closing by IO Module is Not Operational

Problem description	Probable cause	Solution
Device can be closed while selector switch wired on a digital input of the IO module is set to Inhibit (I4=0).	The MicroLogic X setting Breaker closing by digital input is disabled.	In EcoStruxure Power Commission software, in the General menu, in Breaker Closing Inhibition , change the value of the Allow control by a digital input parameter to Enable .

Additional Checks

If the troubleshooting actions described above do not work, the problem might be in the mechanical or electrical operations of the device. Refer to the troubleshooting information for Mechanical Control Operations, page 147 and Electrical Control Operations, page 148.

Troubleshooting: Control Operations from FDM121 Display

Definition

Control operations include commands to open and close the device from the FDM121 display.

For information about control operations from the FDM121 display, refer to DOCA0088EN *Enerlin'X FDM121 – Front Display Module for One Circuit Breaker – User Guide*.

Device Cannot be Controlled from the FDM121 Display

Problem description	Symptom	Probable causes	Solutions
The FDM121 display does not display any data when connected to the MicroLogic X control unit.	The FDM121 display screen blinks continuously, indicating a conflict in the IMU.	The FDM121 firmware version is not compatible with the MicroLogic X control unit.	<ol style="list-style-type: none"> 1. Remove the MasterPact device from the IMU in which the FDM121 display is installed. 2. Update the FDM121 firmware to the last firmware version, 004.000.009 or later, by using EcoStruxure Power Commission software. 3. Connect the MasterPact device in the IMU again. <p>For more information about updating the firmware, see DOCA0150EN <i>Enerlin'X FDM121 - Front Display Module for One Circuit Breaker - Firmware Release Notes</i>.</p>
Device cannot be opened or closed.	–	The device control mode is set to Manual.	Change the control mode to Auto.
	–	The device control mode is set to Auto Remote.	Change the control mode to Auto Local.
Device cannot be closed.	–	The close command is inhibited by the IO module.	Enable the close command by using the selector switch wired on a digital input of the IO module (I=1).
		The close command is inhibited by a command from the communication network or EcoStruxure Power Commission software.	In EcoStruxure Power Commission software, in the Device Check-up > Devices menu, change the value of the Remote Close Breaker Inhibited parameter from Enabled by communication to Disabled .

Inhibit Closing by IO Module is Not Operational

Problem description	Probable cause	Solution
Device can be closed while selector switch wired on a digital input of the IO module is set to Inhibit (I4=0).	The MicroLogic X setting Breaker closing by digital input is disabled.	In EcoStruxure Power Commission software, in the General menu, in Breaker Closing Inhibition , change the value of the Allow control by a digital input parameter to Enable .

Additional Checks

If the troubleshooting actions described above do not work, the problem might be in the mechanical or electrical operations of the device. Refer to the troubleshooting information for Mechanical Control Operations, page 147 and Electrical Control Operations, page 148.

Troubleshooting: Control Operations from EcoStruxure Power Commission Software

Definition

Control operations include commands to open and close the device from EcoStruxure Power Commission software.

Device Cannot be Controlled from EcoStruxure Power Commission Software Connected to a Mini USB Port

Problem description	Symptom	Probable causes	Solutions
Device cannot be opened or closed.	EcoStruxure Power Commission message: Breaker operation not successful: actuator is in manual mode. Remote breaker commands are not allowed	The device control mode is set to Manual.	Change the control mode to Auto.
	EcoStruxure Power Commission message: Breaker operation not successful: Operation mode is Remote	The device control mode is set to Auto Remote.	Change the control mode to Auto Local.
	EcoStruxure Power Commission software does not display the relevant option.	Insufficient access rights.	Log in to EcoStruxure Power Commission software with Administrator rights.
	EcoStruxure Power Commission message: Insufficient user rights (incorrect password)	The password is incorrect: error entering password or the user has insufficient access rights.	Enter the password again. In the case of insufficient access rights, check the password validity with the system administrator.
Device cannot be closed.	EcoStruxure Power Commission message: Breaker operation not successful: The requested action is not allowed as it has been previously inhibited	The close command is inhibited by the IO.	Enable the close command by using the selector switch wired on a digital input of the IO module (I=1).
		The close command is inhibited by a command from the communication network or EcoStruxure Power Commission software.	In EcoStruxure Power Commission software, in the Device Check-up > Devices menu, change the value of the Remote Close Breaker Inhibited parameter from Enabled by communication to Disabled .

Inhibit Closing by IO Module is Not Operational

Problem description	Probable cause	Solution
Device can be closed while selector switch wired on a digital input of the IO module is set to Inhibit (I4=0).	The MicroLogic X setting Breaker closing by digital input is disabled.	In EcoStruxure Power Commission software, in the General menu, in Breaker Closing Inhibition , change the value of the Allow control by a digital input parameter to Enable .

Device Cannot be Controlled from EcoStruxure Power Commission Software Connected by IFE, EIFE, or IFM Interface

Symptom	Probable causes	Solutions
EcoStruxure Power Commission message: Breaker operation not successful: Either device is unable to execute the operation or communication interface is locked	The remote control commands are disabled by the locking pad on the front of the IFE interface.	Move the locking pad on the front of the IFE interface to the Unlocked position.
	The EIFE interface is locked by EcoStruxure Power Commission software.	In EcoStruxure Power Commission software, in the Configure > Communication menu, change the value of the Remote Padlock Position parameter from Locked to Unlocked .
EcoStruxure Power Commission message: Breaker operation not successful: actuator is in manual mode. Remote breaker commands are not allowed	The device control mode is set to Manual.	Change the control mode to Auto.
EcoStruxure Power Commission software does not display the relevant option.	Insufficient access rights.	Log in to EcoStruxure Power Commission software with Administrator rights.
EcoStruxure Power Commission message: Breaker operation is not successful: Operation mode is Local (Operation via remote control is not allowed)	The device control mode is set to Auto Local.	Change the control mode to Auto Remote.
EcoStruxure Power Commission message: Insufficient user rights: Incorrect password	The password is incorrect: error entering password or the user has insufficient access rights.	Enter the password again. In the case of insufficient access rights, check the password validity with the system administrator.

Additional Checks

If the troubleshooting actions described above do not work, the problem might be in the mechanical or electrical operations of the device. Refer to the troubleshooting information for [Mechanical Control Operations](#), page 147 and [Electrical Control Operations](#), page 148.

Troubleshooting: Control Operations from IFE/EIFE Webpages

Definition

Control operations include commands to open and close the device from IFE or EIFE webpages.

For information about control operations from IFE or EIFE webpages, refer to the following guides:

- DOCA0084EN *Enerlin'X IFE – Ethernet Switchboard Server – User Guide*
- DOCA0142EN *Enerlin'X IFE - Ethernet Interface for One IEC Circuit Breaker – User Guide*
- DOCA0106EN *Enerlin'X EIFE – Embedded Ethernet Interface for One MasterPact MTZ Drawout Circuit Breaker – User Guide*

Device Cannot be Controlled from IFE or EIFE Webpages

Problem description	Symptom	Probable causes	Solutions
Device cannot be opened or closed.	The Close and Open buttons are not displayed on the webpage.	Application control is not enabled in the IFE interface.	Enable application control by pressing the Test button on the front of the IFE interface for 10–15 s.
		The user is not logged in as Administrator.	Log in as Administrator.
	Message on webpage: Breaker operation not successful: actuator is in manual mode. Remote breaker commands are not allowed	The device control mode is set to Manual.	Change the control mode to Auto.
	Message on webpage: Breaker operation is not successful: Operation mode is Local (Operation via remote control is not allowed).	The device control mode is set to Auto Local.	Change the control mode to Auto Remote.
	Message on webpage: Close has failed. NOTE: There is no message if opening action fails.	The remote control commands are disabled by the locking pad on the front of the IFE interface.	Move the locking pad on the front of the IFE interface to the Unlocked position.
		The EIFE interface is locked by EcoStruxure Power Commission software.	In EcoStruxure Power Commission software, in the Configure > Communication menu, change the value of the Remote Padlock Position parameter from Locked to Unlocked .
Device cannot be closed.	Message on webpage: Close has failed.	The close command is inhibited by the IO module.	Enable the close command by using the selector switch wired on a digital input of the IO module (I=1).

Problem description	Symptom	Probable causes	Solutions
		The close command is inhibited by a command from the communication network or EcoStruxure Power Commission software.	In EcoStruxure Power Commission software, in the Device Check-up > Devices menu, change the value of the Remote Close Breaker Inhibited parameter from Enabled by communication to Disabled .

Inhibit Closing by IO Module is Not Operational

Problem description	Probable cause	Solution
Device can be closed while selector switch wired on a digital input of the IO module is set to Inhibit (I4=0).	The MicroLogic X setting Breaker closing by digital input is disabled.	In EcoStruxure Power Commission software, in the General menu, in Breaker Closing Inhibition , change the value of the Allow control by a digital input parameter to Enable .

Additional Checks

If the troubleshooting actions described above do not work, the problem might be in the mechanical or electrical operations of the device. Refer to the troubleshooting information for [Mechanical Control Operations](#), page 147 and [Electrical Control Operations](#), page 148.

Troubleshooting: Control Operations from Communication Network

Definition

Control operations include commands to open and close the device from the communication network.

For information about control operations from the communication network, refer to the following guides:

- DOCA0105EN *MasterPact MTZ – Modbus Communication – User Guide*
- DOCA0162EN *MasterPact MTZ - IEC 61850 Communication Guide*

Device Cannot be Controlled with a Remote Controller Connected from IFE, EIFE, or IFM Interface

Problem description	Symptom	Probable causes	Solutions
Device cannot be opened or closed.	–	The device control mode is set to Manual.	Change the control mode to Auto.
	–	The device control mode is set to Auto Local.	Change the control mode to Auto Remote.
	–	The remote control commands are disabled by the locking pad on the front of the IFE interface.	Move the locking pad on the front of the IFE interface to the Unlocked position.
	–	The EIFE interface is locked by EcoStruxure Power Commission software.	In EcoStruxure Power Commission software, in the Configure > Communication menu, change the value of the Remote Padlock Position parameter from Locked to Unlocked .
	The opening or closing command is returned with Modbus error code 01.	The password in the opening or closing is incorrect or the user has insufficient access rights.	Send the opening or closing command with a valid password. In the case of insufficient access rights, check the password validity with the system administrator. If the password is lost, refer to DOCA0105EN <i>MasterPact MTZ – Modbus Communication – User Guide</i> .
Device cannot be closed.	–	The close command is inhibited by the IO module.	Enable the close command by using a selector switch wired on a digital input of the IO module (I=1).
		The close command is inhibited by a command from the communication network or EcoStruxure Power Commission software.	Use the Set Close Breaker Inhibition command to enable the close order.

Inhibit Closing by IO Module is Not Operational

Problem description	Probable cause	Solution
Device can be closed while selector switch wired on a digital input of the IO module is set to Inhibit (I4=0).	The MicroLogic X setting Breaker closing by digital input is disabled.	In EcoStruxure Power Commission software, in the General menu, in Breaker Closing Inhibition , change the value of the Allow control by a digital input parameter to Enable .

Additional Checks

If the troubleshooting actions described above do not work, the problem might be in the mechanical or electrical operations of the device. Refer to the troubleshooting information for Mechanical Control Operations, page 147 and Electrical Control Operations, page 148.

Troubleshooting: Control Operations from FDM128 Display

Definition

Control operations include commands to open and close the device from the FDM128 display.

For information about control operations from the FDM128 display, refer to DOCA0037EN *Enerlin'X FDM128 – Ethernet Display for Eight Devices – User Guide*.

Device Cannot be Controlled from the FDM128 Display

Symptom	Probable causes	Solutions
On FDM128 display, in the Device view, the Control submenu is grayed out.	You are not logged in as Administrator.	Log in to the FDM128 display as Administrator.
	The password is incorrect: error entering password or the user has insufficient access rights.	Enter a valid password. In the case of insufficient access rights, check the password validity with the system administrator.

Additional Checks

If the troubleshooting actions described above do not work, the problem might be linked to the communication network. Refer to the troubleshooting information for the communication network, page 160.

Schneider Electric Green Premium™ Ecolabel

What's in This Part

Schneider Electric Green Premium™ Ecolabel	164
--	-----

Schneider Electric Green Premium™ Ecolabel

Description

Green Premium by Schneider Electric is a label that allows you to develop and promote an environmental policy while preserving your business efficiency. This ecolabel is compliant with up-to-date environmental regulations.



Accessing Green Premium

Green Premium data on labeled products can be accessed online through any of the following ways:

- By navigating to the Green Premium page on the Schneider Electric website.
- By flashing the QR code displayed in the following image:



Checking Products Through the Schneider Electric Website

To check the environmental criteria of a product using a PC or smartphone, follow these steps:

1. From www.se.com, select **Support > Green Premium: RoHS, REACH**.
2. Find **Check a Product** and click **Launch now** to open the search tool webpage.
3. Enter the commercial reference or product range of the product to search for.
4. To search for several products simultaneously, click the **Add** button, and then fill in the field.
5. Click **Check product(s)** to generate a report of the environmental criteria available for the products with the entered commercial references.

Environmental Criteria

The Green Premium ecolabel provides documentation on the following criteria about the environmental impact of the products:

- RoHs: European Union Restriction of Hazardous Substances (RoHS) directive.
- REACH: European Union Registration, Evaluation, Authorization, and Restriction of Chemicals regulation.
- PEP: Product Environmental Profile.
- EoLI: End of Life Instructions.

RoHs

Schneider Electric products are subject to RoHS requirements at a worldwide level, even for the many products that are not required to comply with the terms of the regulation. Compliance certificates are available for products that fulfill the criteria of this European initiative, which aims to eliminate hazardous substances.

REACH

Schneider Electric applies the strict REACH regulation on its products at a worldwide level, and discloses extensive information concerning the presence of SVHC (Substances of Very High Concern) in all of these products.

PEP

Schneider Electric publishes complete set of environmental data, including carbon footprint and energy consumption data for each of the life cycle phases on all of its products, in compliance with the ISO 14025 PEP ecopassport program. PEP is especially useful for monitoring, controlling, saving energy, and/or reducing carbon emissions.

EoLI

These instructions provide:

- Recyclability rates for Schneider Electric products.
- Guidance to mitigate personnel hazards during the dismantling of products and before recycling operations.
- Part identification for recycling or for selective treatment, to mitigate environmental hazards/incompatibility with standard recycling processes.

Schneider Electric
35 rue Joseph Monier
92500 Rueil Malmaison
France

+ 33 (0) 1 41 29 70 00

www.se.com

As standards, specifications, and design change from time to time,
please ask for confirmation of the information given in this publication.

© 2022 Schneider Electric. All rights reserved.

DOCA0100EN-05