



Product designation	Power contactor		
Product type designation	BFK09		
Contact characteristics			
Number of poles	Nr.	3	
Rated insulation voltage U_i IEC/EN	V	690	
Rated impulse withstand voltage U_{imp}	kV	6	
Operational frequency	min	Hz	25
	max	Hz	400
IEC Conventional free air thermal current I_{th}	A	25	
Rated operational power AC-6b ($T \leq 40^\circ C$)	230V	kvar	4.5
	400V	kvar	7.5
	440...480V	kvar	9
	690V	kvar	10
Short-time allowable current for 10s (IEC/EN60947-1)	A	150	
Protection fuse	gG (IEC)	A	16
	Making capacity (RMS value)	A	90
Breaking capacity at voltage	440V	A	72
	500V	A	72
	690V	A	71
	Resistance per pole (average value)	m Ω	2.5
Power dissipation per pole (average value)	I_{th}	W	1.6
	Tightening torque for terminals	min	Nm
max		Nm	1.8
min		lbin	1.1
max		lbin	1.5
Tightening torque for coil terminal	min	Nm	0.8
	max	Nm	1
	min	lbin	0.8
	max	lbin	0.74
Max number of wires simultaneously connectable	Nr.	2	
Conductor section	AWG/Kcmil	max	10
	Flexible w/o lug conductor section	min	mm ² 1
max		mm ² 6	
Flexible c/w lug conductor section	min	mm ² 1	

	max	mm ²	4
Flexible with insulated spade lug conductor section	min	mm ²	1
	max	mm ²	4
Power terminal protection according to IEC/EN 60529			IP20 when properly wired
Mechanical features			
Operating position	normal allowable		Vertical plan ±30°
Fixing			Screw / DIN rail 35mm
Weight		g	416
Conductor section	AWG/kcmil conductor section		
	max		10
Auxiliary contact characteristics			
Thermal current I _{th}		A	10
IEC/EN 60947-5-1 designation			A600 - P600
Operating current AC15	230V	A	3
	400V	A	1.9
	500V	A	1.4
Operating current DC12	110V	A	5.7
Operating current DC13	24V	A	5.7
	48V	A	2.9
	60V	A	2.3
	110V	A	1.25
	125V	A	1.1
	220V	A	0.6
	600V	A	0.1
Operations			
Mechanical life		cycles	20000000
Electrical life		cycles	400000
Safety related data			
Performance level B10d according to EN/ISO 13489-1	rated load	cycles	400000
	mechanical load	cycles	20000000
Mirror contacts according to IEC/EN 60947-4-1			YES
EMC compatibility			yes
AC coil operating			
Rated AC voltage at 60Hz		V	460
AC operating voltage	of 60Hz coil powered at 60Hz		
	pick-up		
	min	%Us	80
	max	%Us	110
	drop-out		
	min	%Us	20
	max	%Us	55
AC average coil consumption at 20°C			

of 60Hz coil powered at 60Hz

	in-rush	VA	75
	holding	VA	9
Dissipation at holding ≤20°C 50Hz		W	2.5

Max cycles frequency

Mechanical operation		cycles/h	3600
----------------------	--	----------	------

Operating times

Average time for Us control
in AC

Closing NO

min	ms	8
max	ms	24

Opening NO

min	ms	10
max	ms	20

Closing NC

min	ms	14
max	ms	28

UL technical data

General USE

Contactor

AC current	A	25
------------	---	----

Auxiliary contacts

AC voltage	V	600
AC current	A	10
DC voltage	V	250
DC current	A	1

Contact rating of auxiliary contacts according to UL

A600 - P600

Ambient conditions

Temperature

Operating temperature

min	°C	-50
max	°C	70

Storage temperature

min	°C	-60
max	°C	80

Max altitude

m 3000

Resistance & Protection

Pollution degree

3

Dimensions

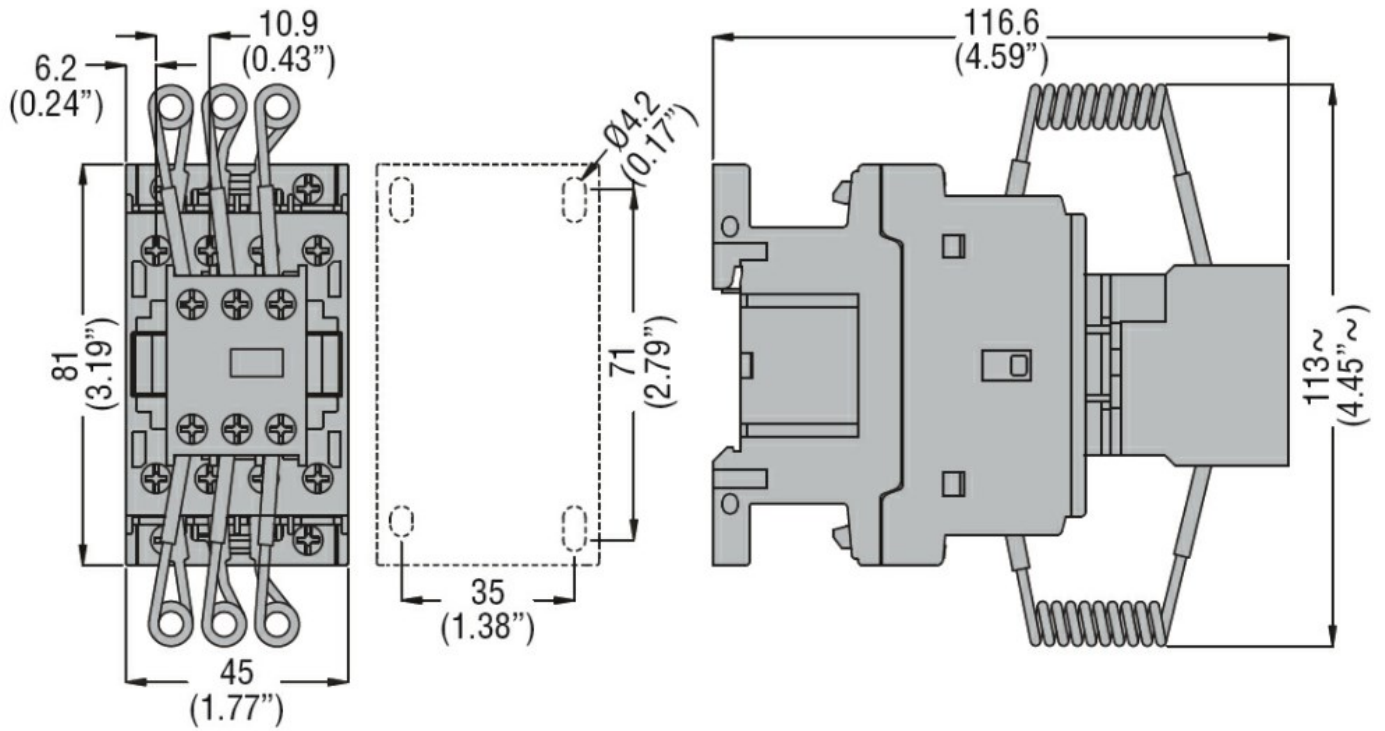

Wiring diagrams

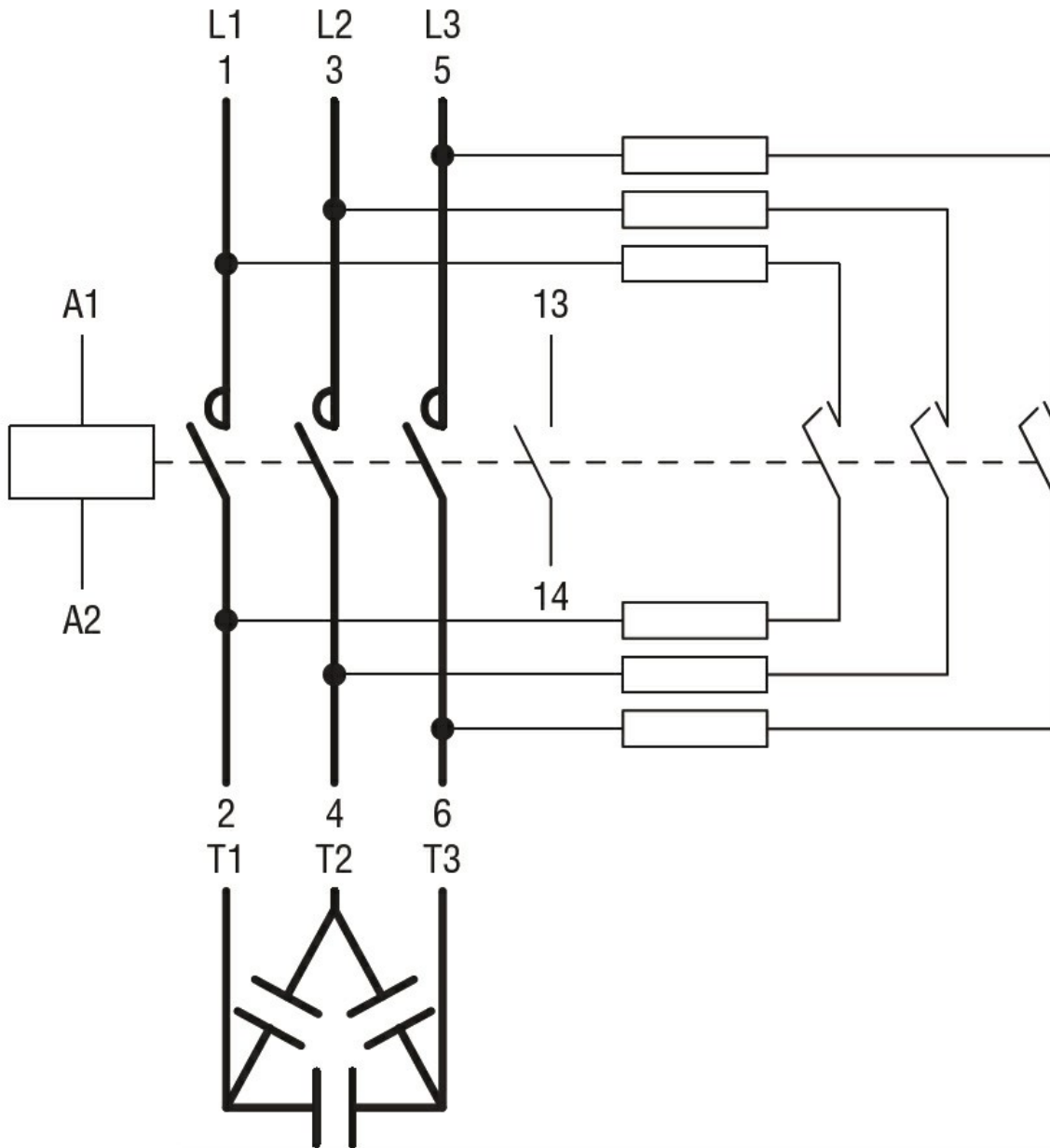

Certifications and compliance

Compliance

CSA C22.2 n° 60947-1
CSA C22.2 n° 60947-4-1
IEC/EN/BS 60947-1
IEC/EN/BS 60947-4-1
UL 60947-1
UL 60947-4-1

Certificates

CCC
cULus
EAC

ETIM classification

ETIM 8.0

EC001079 -
Capacitor
contactor