



Product designation				Power contactor
Product type designation				BF95
Contact characteristics				
Number of poles	Nr.			4
Rated insulation voltage U _i IEC/EN	V			1000
Rated impulse withstand voltage U _{imp}	kV			8
Operational frequency	min	Hz	25	
	max	Hz	400	
IEC Conventional free air thermal current I _{th}	A			140
Operational current I _e	AC-1 (≤40°C)	A	140	
	AC-1 (≤55°C)	A	115	
	AC-1 (≤70°C)	A	100	
	AC-3 (≤440V ≤55°C)	A	95	
	AC-4 (400V)	A	45	
Rated operational current AC-3 (T≤55°C)	230V	A	95	
	400V	A	95	
	415V	A	95	
	440V	A	95	
	500V	A	95	
	690V	A	93	
	1000V	A	33	
IEC max current I _e in DC1 with L/R ≤ 1ms with 1 poles in series	≤24V	A	140	
	48V	A	140	
	75V	A	100	
	110V	A	10	
	220V	A	–	
IEC max current I _e in DC1 with L/R ≤ 1ms with 2 poles in series	≤24V	A	140	
	48V	A	140	
	75V	A	140	
	110V	A	110	
	220V	A	12	
IEC max current I _e in DC1 with L/R ≤ 1ms with 3 poles in series	≤24V	A	140	
	48V	A	140	
	75V	A	155	
	110V	A	120	
	220V	A	125	
IEC max current I _e in DC1 with L/R ≤ 1ms with 4 poles in series	≤24V	A	140	
	48V	A	140	

	75V	A	155
	110V	A	140
	220V	A	140
<hr/>			
IEC max current I _e in DC3-DC5 with L/R ≤ 15ms with 1 poles in series	≤24V	A	140
	48V	A	44
	75V	A	36
	110V	A	6
	220V	A	–
<hr/>			
IEC max current I _e in DC3-DC5 with L/R ≤ 15ms with 2 poles in series	≤24V	A	140
	48V	A	63
	75V	A	60
	110V	A	55
	220V	A	7
<hr/>			
IEC max current I _e in DC3-DC5 with L/R ≤ 15ms with 3 poles in series	≤24V	A	140
	48V	A	115
	75V	A	90
	110V	A	85
	220V	A	76
<hr/>			
IEC max current I _e in DC3-DC5 with L/R ≤ 15ms with 4 poles in series	≤24V	A	140
	48V	A	110
	75V	A	110
	110V	A	105
	220V	A	95
<hr/>			
Short-time allowable current for 10s (IEC/EN60947-1)		A	760
<hr/>			
Protection fuse	gG (IEC)	A	160
	aM (IEC)	A	100
<hr/>			
Making capacity (RMS value)		A	1200
<hr/>			
Breaking capacity at voltage	440V	A	1100
	500V	A	775
	690V	A	745
<hr/>			
Resistance per pole (average value)		mΩ	0.45
<hr/>			
Power dissipation per pole (average value)	I _{th}	W	8.8
	AC-3	W	4.1
<hr/>			
Tightening torque for terminals	min	Nm	6
	max	Nm	7
	min	lbin	4.4
	max	lbin	5.2
<hr/>			
Tightening torque for coil terminal	min	Nm	0.8
	max	Nm	1
	min	lbin	0.59
	max	lbin	0.74
<hr/>			
Conductor section	AWG/Kcmil		
	max		2/0

Flexible w/o lug conductor section	min	mm ²	1.5
	max	mm ²	70
Flexible c/w lug conductor section	min	mm ²	1.5
	max	mm ²	70
Power terminal protection according to IEC/EN 60529			IP20 front
Mechanical features			
Operating position	normal allowable		Vertical plan ±30°
Fixing			Screw / DIN rail 35mm
Weight		g	2420
Conductor section	AWG/kcmil conductor section		
	max		2/0
Auxiliary contact characteristics			
Thermal current I _{th}		A	140
Operations			
Mechanical life		cycles	15000000
Electrical life		cycles	1400000
AC coil operating			
Rated AC voltage at 50/60Hz		V	230
AC operating voltage	of 50/60Hz coil powered at 50Hz		
	pick-up		
	min	%Us	80
	max	%Us	110
	drop-out		
	min	%Us	20
	max	%Us	55
	of 50/60Hz coil powered at 60Hz		
	pick-up		
	min	%Us	85
	max	%Us	110
	drop-out		
	min	%Us	40
	max	%Us	55
AC average coil consumption at 20°C	of 50/60Hz coil powered at 50Hz		
	in-rush	VA	300
	holding	VA	20
	of 50/60Hz coil powered at 60Hz		
	in-rush	VA	275
	holding	VA	17
	of 60Hz coil powered at 60Hz		
	in-rush	VA	300
	holding	VA	20
Dissipation at holding ≤20°C 50Hz		W	6.5
Max cycles frequency			
Mechanical operation		cycles/h	1500
Operating times			
Average time for U _s control			

in AC

Closing NO

min	ms	16
max	ms	32

Opening NO

min	ms	9
max	ms	24

UL technical data

General USE

Contactor

AC current A 150

Short-circuit protection fuse, 600V
High fault

Short circuit current	kA	100
Fuse rating	A	200
Fuse class		J

Standard fault

Short circuit current	kA	10
Fuse rating	A	250
Fuse class		RK5

Ambient conditions

Temperature

Operating temperature

min	°C	-50
max	°C	70

Storage temperature

min	°C	-60
max	°C	+80

Max altitude

m 3000

Dimensions

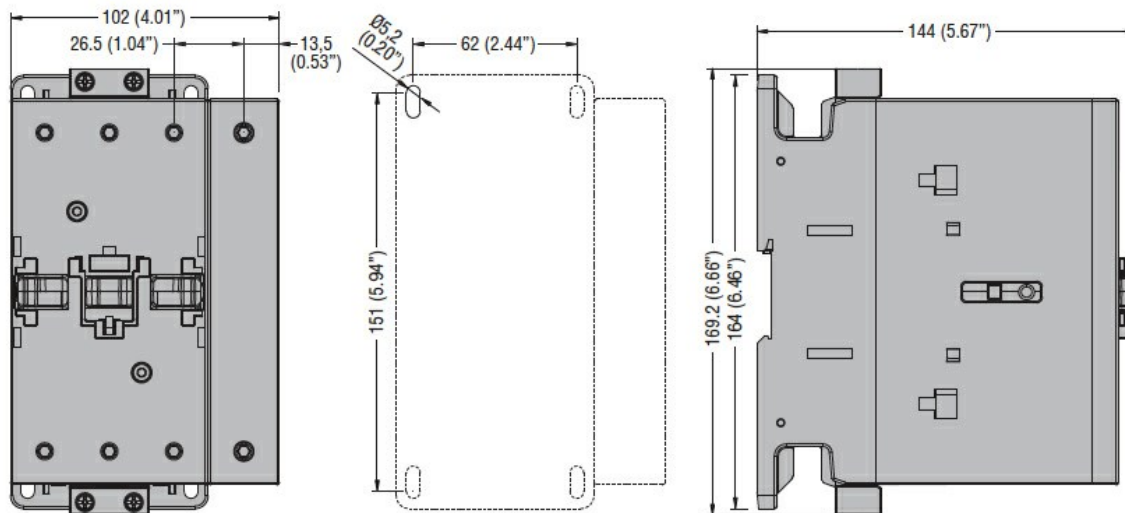

Wiring diagrams

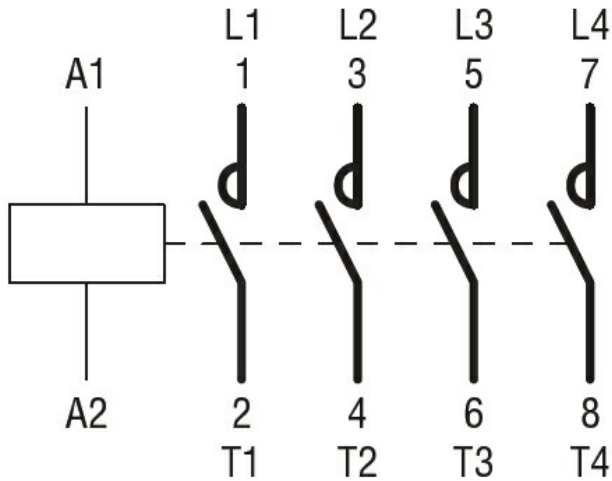

Certifications and compliance

Compliance

CSA C22.2 n° 60947-1

CSA C22.2 n° 60947-4-1

IEC/EN/BS 60947-1

IEC/EN/BS 60947-4-1

UL 60947-1

UL 60947-4-1

Certificates

CCC

cULus

EAC

ETIM classification

ETIM 8.0

EC000066 -
Power contactor,
AC switching