

# Power Analyser

## UMG 96 RM-PN

Operation manual and  
technical data

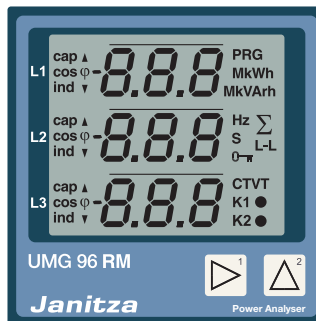

Janitza electronics GmbH  
Vor dem Polstück 1  
D-35633 Lahnau  
Support tel. 0049 6441 9642-22  
Fax 0049 6441 9642-30  
E-mail: [info@janitza.com](mailto:info@janitza.com)  
Internet: <http://www.janitza.com>

**Janitza®**

## Table of contents

<b>General information</b>	<b>4</b>	Parameters and measured values	46
<b>Inspection on receipt</b>	<b>6</b>	<b>Configuration</b>	<b>48</b>
Scope of delivery, UMG 96RM-PN	7	Connecting the supply voltage	48
Available accessories	7	Current and voltage transformer	48
<b>Product description</b>	<b>8</b>	Programming the current transformer for I1-I3	50
Proper use	8	Programming the voltage transformer	51
UMG 96RM-PN features	10	Programming parameters	52
Measuring process	11	TCP/IP configuration	53
Operating concept	11	RS485 device address (addr. 000)	55
GridVis network analysis software	11	RS485 baud rate (addr. 001)	55
Connection variants	12	User password (addr. 050)	56
<b>Assembly</b>	<b>13</b>	<b>Parameters</b>	<b>57</b>
<b>Installation</b>	<b>15</b>	Mean value	57
Supply voltage	15	Averaging method	57
Voltage measurement	16	Min. and max. values	57
Current measurement using I1 to I4	22	Mains frequency (addr. 034)	58
Analogue inputs	30	Power meters	59
Residual current monitoring (RCM) via I5, I6	31	Resetting energy meters (addr. 507)	59
Thermistor input	33	Harmonics	60
RS485 interface	34	Measured value rotation	61
Ethernet / ProfiNET interface	37	Measured value screens	61
Digital in-/outputs	39	Direction of the rotating field	63
LED status bar	43	LCD contrast (addr. 035)	63
<b>Operation</b>	<b>44</b>	Backlight	63
Display mode	44	Time logging	65
Programming mode	44	Operating hours counter	65

Total running time, comparator	65	<b>Error / warning messages</b>	<b>90</b>
Serial number (addr. 754)	66	<b>Technical data</b>	<b>96</b>
Software release (addr. 750)	66	Function parameters	102
<b>Commissioning</b>	<b>68</b>	Table 1 - Parameter list	104
Connecting the supply voltage	68	Table 2 - Modbus address list	111
Connecting the measured voltage	68	Number formats	114
Applying the measuring-circuit voltage	68	Dimension diagrams	116
Direction of the rotating field	69	<b>Measured value screen overview</b>	<b>118</b>
Checking the phase assignment	69	<b>Declaration of conformity</b>	<b>124</b>
Checking the power measurement	69	<b>Connection example 1</b>	<b>125</b>
Applying the residual current	69	<b>Connection example 2</b>	<b>126</b>
Failure monitoring (RCM) for I5, I6	70	<b>Basic functions quick guide</b>	<b>127</b>
Checking the measurement	71	<b>TCP/IP addressing quick guide</b>	<b>128</b>
Checking the single phase powers	71		
Checking the sum powers	71		
<b>RS485 interface</b>	<b>72</b>		
<b>Digital outputs</b>	<b>74</b>		
Digital output status indicators	75		
Pulse output (Group 1)	77		
Comparators and threshold value monitoring	82		
<b>Service and maintenance</b>	<b>88</b>		
Service	88		
Device calibration	88		
Calibration intervals	88		
Firmware update	89		

## General information

### Copyright

This manual is subject to the statutory provisions of copyright law and may not be photocopied, reprinted, or reproduced - in whole or in part, by mechanical or electronic means - nor otherwise duplicated or republished, without the binding written permission of:

Janitza electronics GmbH, Vor dem Polstück 1,  
D 35633 Lahnu, Germany

### Trademarks

All trademarks and the resulting rights are the property of their respective owners.

### Disclaimer

Janitza electronics GmbH accepts no responsibility for errors or deficiencies within this manual, and makes no commitment to keep the contents of this functional description up to date.

## Comments on the manual

We welcome your comments. If anything in this manual seems unclear, please let us know by sending an e-mail to: [info@janitza.de](mailto:info@janitza.de)

## Meaning of symbols

This manual uses the following pictograms:



### Dangerous voltage!

Risk to life or serious injury. Before commencing work on the system and the device, they must first be de-energised.



### Attention!

Please pay attention to the documentation. This symbol is intended to warn you of potential dangers, which could occur during installation, commissioning and use.



### Note!

## Instructions on use

Please read this operation manual as well as all other publications that must be consulted for working with this product (in particular, for the installation, operation or maintenance).

Observe all safety instructions and warnings. Failure to comply with the instructions can result in personal injuries and/or damage to the product.

Any unauthorised changes or use of this device, which go beyond the mechanical, electrical or otherwise stated operating limitations, can result in bodily injury or/and damage to the product.

Any such unauthorised change constitutes "misuse" and/or "negligence" according to the warranty for the product and thus excludes the warranty for covering possible damage resulting from this.

This device must only be operated and repaired by specialised personnel.

Specialised personnel are persons, that based on their respective training and experience, are qualified to recognise risks and prevent potential dangers that

can be caused by the operation or maintenance of the device.

Additional legal and safety regulations required for the respective application are to be followed during the use of the device.



If the device is not operated according to the operation manual, protection is no longer ensured and hazards can be presented by the device.



Single core conductor must be provided with core end sheath.



Only pluggable screw terminals with the same number of poles and the same type of construction are permitted to be connected together.

## Concerning this operation manual

This operation manual is part of the product.

- Read the operation manual before using the device.
- Keep the operation manual instructions throughout the entire service life of the product and have them readily available for reference.
- Pass the operation manual on to each subsequent owner or user of the product.



All screw-type terminals included in the scope of delivery are attached to the device.

## Inspection on receipt

The prerequisites of faultless, safe operation of this device are proper transport and proper storage, set-up and installation, as well as careful operation and maintenance. If it can be assumed that risk-free operation is no longer possible, the device must be immediately put out of operation and secured against being put back into operation again.

Packing and unpacking must be carried out with customary care without the use of force and only using suitable tools. The devices should be visually checked for flawless mechanical condition.

It can be assumed that risk-free operation is no longer possible if the device, for example,

- has visible damage,
- no longer works despite the mains power supply being intact,
- has been exposed to prolonged adverse conditions (e.g. storage outside the permissible climate limits without being adapted to the room climate, condensation, etc.) or rough handling during transportation (e.g. falling from a height, even if there is no visible external damage, etc.).
- Please check the delivered items for completeness before you start installing the device.

**Scope of delivery, UMG 96RM-PN**

Number	Part no.	Designation
1	52.22.090	UMG 96RM-PN
2	52.22.251	Mounting clips.
1	33.03.199	Operation manual.
1	51.00.116	CD with following content: - GridVis programming software - GridVis functional description
1	10.01.855	Screw-type terminal, pluggable, 2-pole (auxiliary power)
1	10.01.849	Screw-type terminal, pluggable, 4-pole (voltage measurement)
1	10.01.871	Screw-type terminal, pluggable, 6-pole (current measurement I1-I3)
1	10.01.875	Screw-type terminal, pluggable, 2-pole (current measurement I4)
1	10.01.865	Screw-type terminal, pluggable, 10-pole (digital/analogue inputs/outputs)
1	10.01.857	Screw-type terminal, pluggable, 2-pole (RS 485)
1	10.01.859	Screw-type terminal, pluggable, 3-pole (digital/pulse output)
1	08.01.505	Patch cable 2 m, twisted, grey (connection UMG 96RM-PC/switch)
1	52.00.008	RS485 termination resistor, 120 ohms

**Available accessories**

Part no.	Designation
29.01.907	Seal, 96 x 96
15.06.015	Interface converter RS485 <-> RS232
15.06.025	Interface converter RS485 <-> USB

## Product description

### Proper use

The UMG 96RM-PN is intended for the measurement and calculation of electrical variables such as voltage, current, power, energy, harmonics, etc. in building installations, on distribution units, circuit breakers and busbar trunking systems.

The UMG 96RM-PN is suitable for integration into fixed and weatherproof switch panels. Conductive switch panels must be earthed.

Measured voltages and measured currents must derive from the same network.

The measurement results can be displayed and read out and further processed via the RS485 or ProfiNet interface.

The voltage measurement inputs are designed for measurements in low voltage networks where rated voltages of up to 300V phase to earth and surge voltages of overvoltage category III can occur.

The current measurement inputs I1-I4 of the UMG 96RM-PN are connected via external  $\dots/1A$  or  $\dots/5A$  current transformers.

A continuous monitoring of residual currents (residual current monitor, RCM) is performed via the current measurement inputs I5 and I6 via an external residual current transformer with a rated current of 30 mA.

Measurements in medium and high-voltage networks are always performed via current and voltage transformers.



Residual current monitoring monitors residual currents via external current transformers. The device is **not** an independent protective device!



**Device parameters**

- Supply voltage:  
90V - 277V (45 - 65 Hz) or DC 90V - 250V
- Frequency range: 45 - 65 Hz

**Device functions**

- 3 voltage measurement channels, 300V
- 4 current measurements  
(via current transformer ../5A or ../1A)
- 2 residual current measurements  
(via residual current transformer ../30mA) or  
optionally 2 temperature measurements
- RS485 interface, ethernet and ProfiNet
- 2 digital outputs and additionally 3 digital inputs/  
outputs

## UMG 96RM-PN features

### General information

- Front panel integration device with dimensions 96x96 mm
- Connection via pluggable screw terminals
- LC display with backlight
- Operation via 2 buttons
- 3 Voltage and 4 current measurement inputs
- Either 2 residual current or temperature measurement inputs
- 2 digital outputs and 3 digital inputs/outputs
- RS485 interface (Modbus RTU, slave, up to 115 kbps)
- 2 interfaces for ethernet / ProfiNet
- Working temperature range -10°C to +55°C

### Measurement uncertainty

- Effective energy, measurement uncertainty class 0.5 for ../5A converter
- Effective energy, measurement uncertainty class 1 for ../1A converter
- Reactive energy, class 2

### Measurement

- Measurement in IT, TN and TT networks

- Measurement in networks with rated voltages up to L-L 480V and L-N 277V
- Measurement range current 0 to 5A eff.
- True RMS (TRMS)
- Continuous sampling of the voltage and current measurement inputs
- Continuous monitoring of residual currents with failure monitoring
- Temperature measurement
- Frequency range of the fundamental oscillation 45 Hz to 65 Hz
- Measurement of the 1st to 40th harmonics, for ULN and I1-I3
- Uln, I, P (cons./del.), Q (ind./cap.)
- Capturing substantially more than 1000 measured values
- Fourier analysis 1st to 40th harmonics for U and I1-I3
- 7 power meters for  
Effective energy (cons.), Effective energy (delivery),  
Effective energy (without backstop),  
Reactive energy (in 4 quadrants: delivered, consumed,  
in each case ind./cap.),  
Reactive energy (without backstop), Apparent energy,  
for each of L1, L2, L3 and sum

## Measuring process

The UMG 96RM-PN measures continuously and calculates all effective values over a 10/12 period interval. The device measures the real effective value (TRMS) of the voltages and currents connected to the measurement inputs.

## Operating concept

You can program and call up the measured values via many routes using the UMG 96RM-PN.

- Directly on the device via 2 buttons.
- Using the GridVis programming software.
- Using the device homepage (no programming).
- Using the Modbus protocol.

You can modify and call up the data using the Modbus address list. The list can be called up via the device's home page and can be found on the enclosed CD.

- Using the PLC within a PROFINET environment.

This operation manual only describes how to operate the UMG 96RM-PN using the two buttons.

The GridVis programming software has its own "online help" system.

## GridVis network analysis software

The UMG 96RM-PN can be programmed and read out using the GridVis network analysis software included in the scope of the delivery. For this, a PC must be connected to the UMG 96RM-PN via a serial interface (RS485) or by ethernet.

## GridVis features

- Programming the UMG 96RM-PN
- Graphical representation of measured values

### Connection variants

Connection of a UMG 96RM-PN to a PC via an interface converter:

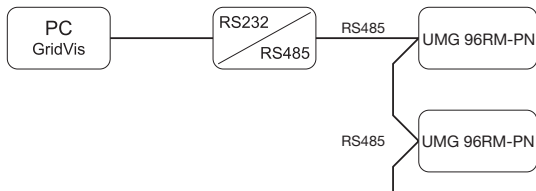

Direct connection of a UMG 96RM-PN to a PC/PLC via Ethernet/ProfiNet.

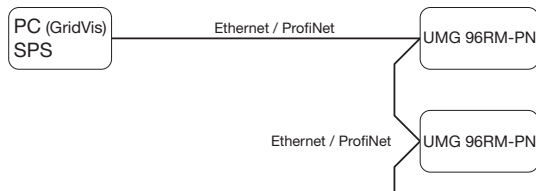

Connection of a UMG 96RM-PN via an UMG 604 as a gateway.

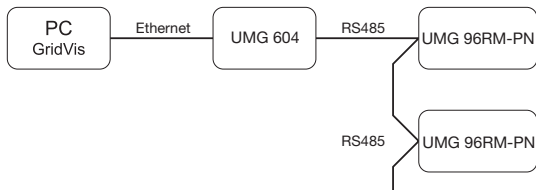

Connection of a UMG 96RM-PN to a PC/PLC via Ethernet/ProfiNet.

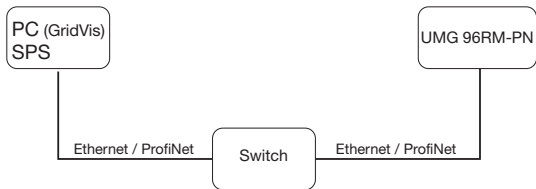

## Assembly

### Position of installation

The UMG 96RM-PN is suitable for integration into fixed and weatherproof switch panels. Conductive switch panels must be earthed.

### Mounting position

To ensure adequate ventilation, the UMG 96RM-PN must be installed vertically. There should be separation above and below of at least 50mm with 20mm space to the sides.

### Front panel section

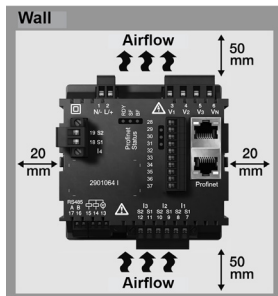

Cut-out size:  
 $92^{+0.8} \times 92^{+0.8}$  mm.

*Fig. Mounting position  
 UMG 96RM-PN  
 (View from rear)*



Failure to meet the minimum clearances can destroy the UMG 96RM-PN at high ambient temperatures!

## Mounting

The UMG 96RM-PN is secured in the switchboard by the mounting clips on the side. Before insertion the device they must be removed, for example by using a screwdriver to lever them horizontally.

*Fig. Side view of the UMG 96RM-PN with mounting clip. To release the clips, use a screwdriver to lever them horizontally.*

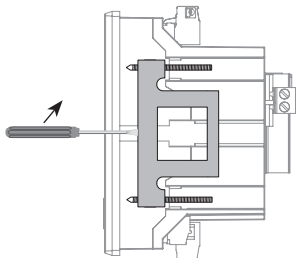

Mounting is then performed by sliding in and engaging the clips and subsequently screwing in the screws.

- Screw in the clamping screws until they are just touching the mounting plate.
- Tighten the clamping screws by two more turns each (tightening the screws too far can destroy the mounting clips).

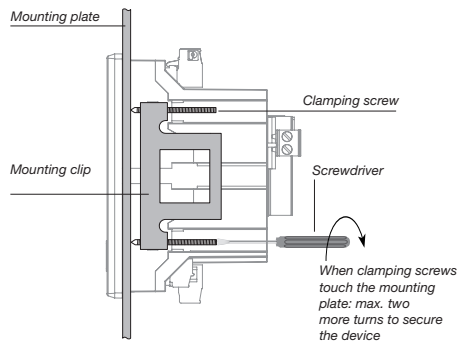

## Installation

### Supply voltage

The UMG 96RM-PN needs a supply voltage to operate. The supply voltage is connected on the rear side of the device via terminal blocks.

Before connecting the supply voltage, ensure that the voltage and frequency correspond to the details on the rating plate!

The supply voltage must be connected through a UL/IEC approved circuit breaker (6A type C).



- If installed in a building, a disconnector or circuit breaker must be provided for the supply voltage.
- The disconnector must be installed near the device and easily accessible to the user.
- The switch must be marked as the circuit breaker for this device.
- Voltages which are over the permitted voltage range can destroy the device.

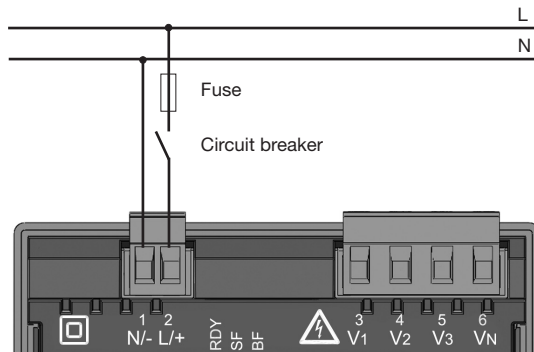

*Fig. Connection example of the supply voltage to a UMG 96RM*

### Voltage measurement

You can use the UMG 96RM-PN for voltage measurement in TN, TT, and IT systems.

Voltage measurement in the UMG 96RM-PN is designed for the overvoltage category 300V CAT III (measurement voltage surge 4kV).

In systems with no N, measured values requiring an N refer to a calculated N.

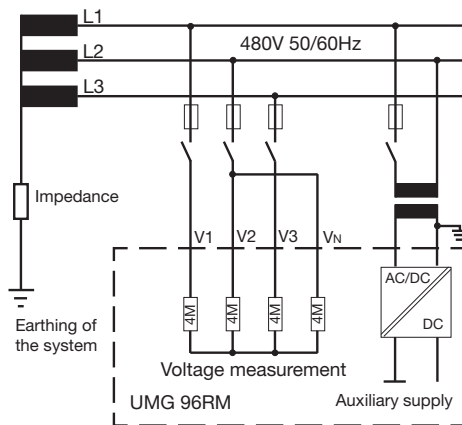
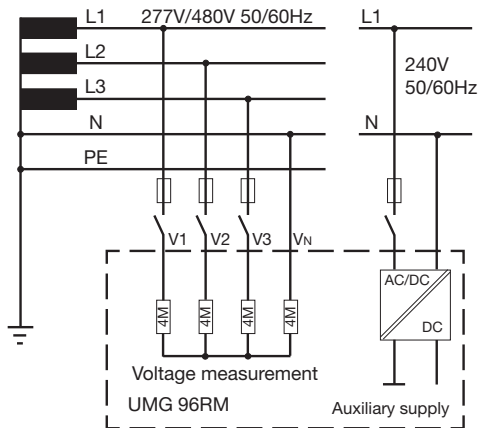

Fig. Schematic diagram - Measurement on three-phase 4-conductor systems.

Fig. Schematic diagram - Measurement on three-phase 3-conductor systems.



## Nominal network voltage

Lists of networks and their nominal network voltages in which the UMG 96RM-PN can be used.

### Three-phase 4-conductor systems with earthed neutral conductor.

$U_{L-N} / U_{L-L}$
66V / 115V
120V / 208V
127V / 220V
220V / 380V
230V / 400V
240V / 415V
260V / 440V
277V / 480V

Maximum system rated voltage

Fig. Table for network rated voltages i.a.w. EN60664-1:2003 suitable for the voltage measurement inputs.

### Unearthed three-phase 3-conductor systems.

$U_{L-L}$
66V
120V
127V
220V
230V
240V
260V
277V
347V
380V
400V
415V
440V
480V

Maximum system rated voltage

Fig. Table for network rated voltages i.a.w. EN60664-1:2003 suitable for the voltage measurement inputs.

### Voltage measurement inputs

The UMG 96RM-PN has three voltage measurement inputs (V1, V2, V3).

#### Overvoltage

The voltage measurement inputs are suitable for measurements in networks where overvoltages of overvoltage category 300V CATIII (measurement voltage surge 4kV) can occur.

#### Frequency

The UMG 96RM-PN requires the mains frequency for the measurement and calculation of measured values.

The UMG 96RM-PN is suitable for measuring in the frequency range from 45 to 65 Hz.

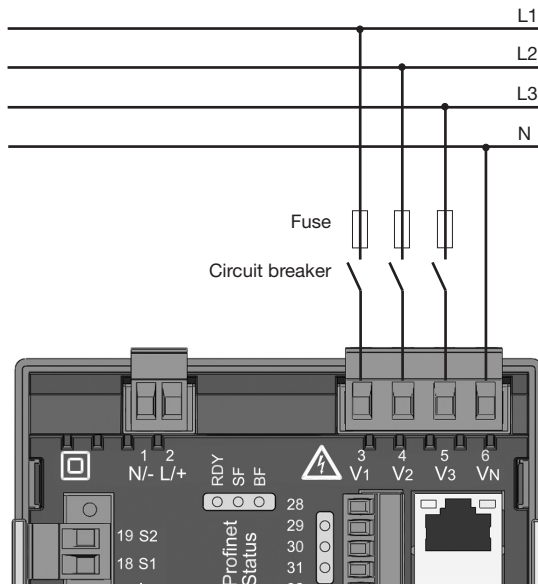

Fig. Example connection for measuring voltage.

When connecting the voltage to be measured, the following must be observed:

- A suitable circuit breaker must be fitted to disconnect and de-energise the UMG 96RM-PN.
- The circuit breaker must be placed in the vicinity of the UMG 96RM-PN, be marked for the user and easily accessible.
- Use a UL/IEC approved circuit breaker 10A (Type C) for the overcurrent protection and disconnect.
- The overcurrent protection must have a rated value, which is suitable for the short circuit current at the connection point.
- Measured voltages and measured currents must derive from the same network

**Attention!**

Voltages that exceed the allow nominal network voltages must be connected via a voltage transformer.

**Attention!**

The UMG 96RM-PN is not suitable for measuring DC voltages.

**Attention!**

The voltage measurement inputs on the UMG 96RM-PN are dangerous if touched!

## Connection schematics, voltage measurement

- 3p 4w (addr. 509= 0), factory default setting

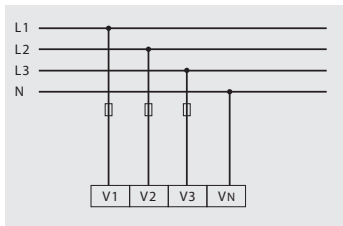

Fig. System with three phase conductors and a neutral conductor.

- 3p 4u (addr. 509 = 2)

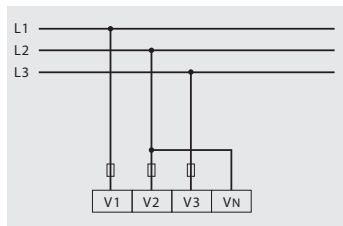

Fig. System with three phase conductors without a neutral conductor. Measured values which require an N refer to a calculated N.

- 3p 4wu (addr. 509 = 1)

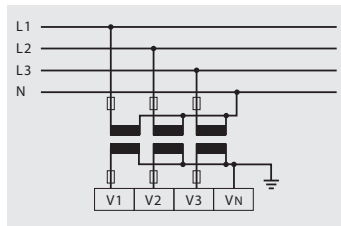

Fig. System with three phase conductors and a neutral conductor. Measurement made with a voltage transformer.

- 3p 2u (addr. 509 = 5)

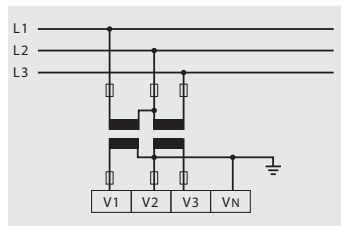

Fig. System with three phase conductors without a neutral conductor. Measurement made with a voltage transformer. Measured values which require an N refer to a calculated N.

- 1p 2w1 (addr. 509 = 4)

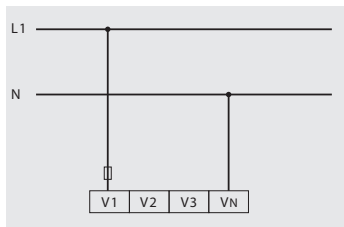

Fig. Measured values derived from voltage measurement inputs V2 and V3 are taken to be zero and are not calculated.

- 1p 2w (addr. 509 = 6)

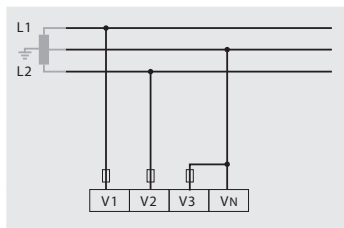

Fig. TN-C system with single-phase three-conductor connection. Measured values derived from voltage measurement input V3 are taken to be zero and are not calculated.

- 2p 4w (addr. 509 = 3)

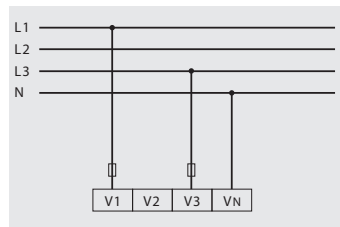

Fig. System with equal loading of the phases. The measured values for voltage measurement input V2 are calculated.

- 3p 1w (addr. 509 = 7)

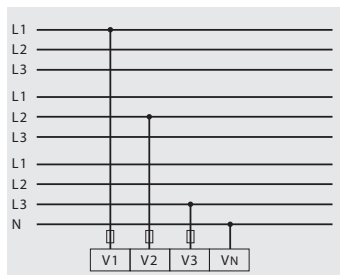

Fig. 3 systems with equal loading of the phases.

### Current measurement using I1 to I4

The UMG 96RM-PN is intended for the connection of current transformers with secondary currents of  $\dots/1A$  and  $\dots/5A$ , via terminals I1-I4. The factory default for the current transformer ratio is 5/5A and must be adapted to the current transformer employed if necessary.

Direct measurement without a current transformer is not possible with the UMG 96RM-PN.

Only AC currents can be measured - DC currents cannot.

**Current measurement input I4** only produces an apparent current measurement, due to there being no multiplier with a voltage. Power measurements are therefore not possible with input I4.

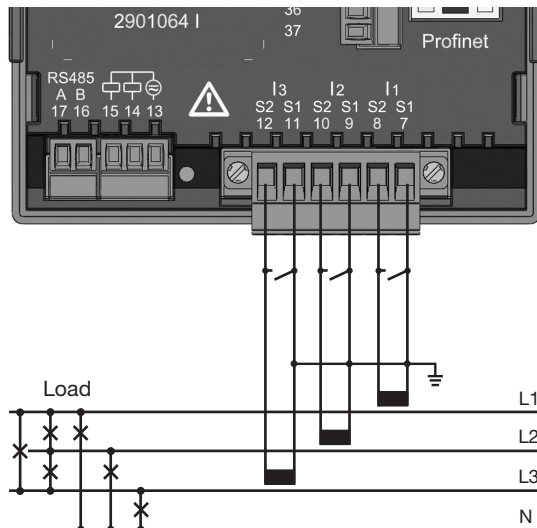

Fig. Current measurement (I1-I3) via current transformers (connection example)



**Attention!**

The current measurement inputs are dangerous to touch.



The attached screw-type terminal must be fixed using the two screws on the device!



### Earthing of current transformers!

If a connection is provided for the earthing of secondary windings, then it must be connected to the earth.



### Attention!

The UMG 96RM-PN is not suitable for measuring DC voltages.



It is not necessary to configure a connection schematic for measurement input I4.

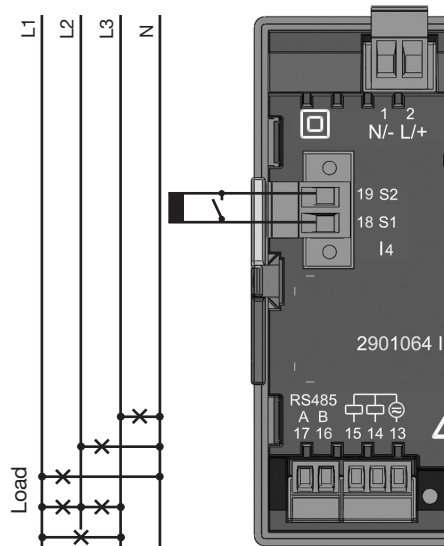

Fig. Current measurement (I4) via current transformers (connection example)

## Current direction

The current direction can be individually corrected via the existing serial interfaces or on the device for each phase.

If incorrectly connected, a subsequent re-connection of the current transformer is not required.

With residual current monitoring (RCM) there is no directional sensitivity of the residual currents on the network or load sides (not directionally sensitive).



### Attention!

Residual current monitoring is performed using the terminals I5 and I6 (cf. page 30). There is **no** directional sensitivity of the residual currents of the network or load sides (not directionally sensitive).



### Earthing of current transformers!

If a connection is provided for the earthing of secondary windings, then it must be connected to the earth.



### Current transformer connections!

The secondary connection of the current transformer must be short circuited on this before the current feed to the UMG 96RM-PN is disconnected!

If a test switch, which automatically short-circuits the secondary wires of the current transformer, is available then it is sufficient to set this to the "Test" position insofar as the short-circuiting device has been checked beforehand.



### Open-circuit current transformers!

High voltage spikes that are dangerous to touch can occur on current transformers that are driven with open-circuit secondary windings!

With "safe open-circuit current transformers" the winding insulation is rated such that the current transformer can be driven open. However, even these current transformers are dangerous to touch when they are driven open-circuit.



**Attention!**

The UMG96RM is only approved for measuring current with a current transformer.

## Connection schematics, current measurement (I1-I3)

- 3p 4w (addr. 510 = 0), factory default setting

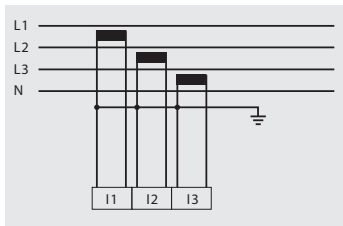

Fig. Measurement in a three-phase network with unequal loading.

- 3p 2i (addr. 510 = 1)

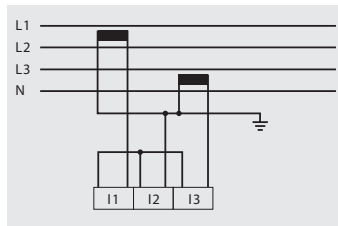

Fig. System with equal loading of the phases. The measured values for current measurement input I2 are measured.

- 3p 2i0 (addr. 510 = 2)

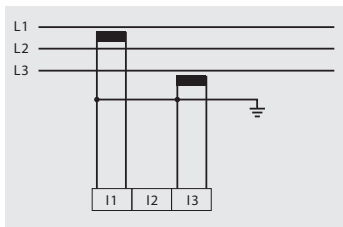

Fig. The measured values for current measurement input I2 are calculated.

- 3p 3w3 (addr. 510 = 3)

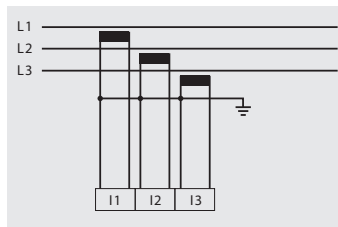
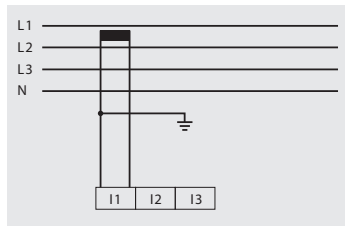

Fig. Measurement in a three-phase network with unequal loading.

- 3p 3w (addr. 510 = 4)



*Fig. System with equal loading of the phases. The measured values for current measurement inputs I2 and I3 are calculated.*

- 2p 4w (addr. 510 = 5)

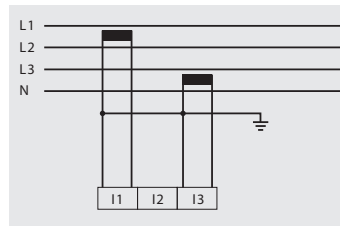

*Fig. System with equal loading of the phases. The measured values for current measurement input I2 are calculated.*

- 1p 2i (addr. 510 = 6)

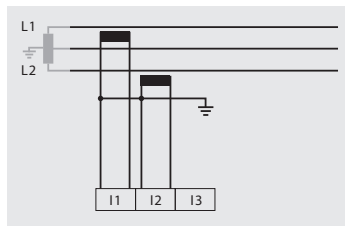

*Fig. Measured values derived from current measurement input I3 are taken to be zero and are not calculated.*

- 1p 2w (addr. 510 = 7)

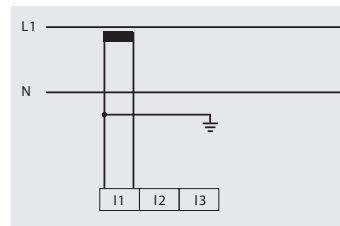

*Fig. Measured values derived from current measurement inputs I2 and I3 are taken to be zero and are not calculated.*

## Connection schematics, current measurement (I1-I3)

- 3p 1w (addr. 510 = 8)

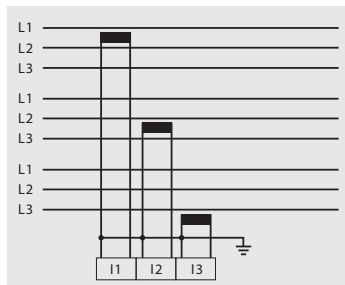

Fig. 3 systems with equal loading of the phases.

## Ammeter

If you wish to measure the current not only with the UMG 96RM but rather with an ammeter too, the ammeter must be connected to the UMG 96RM-PN in series.

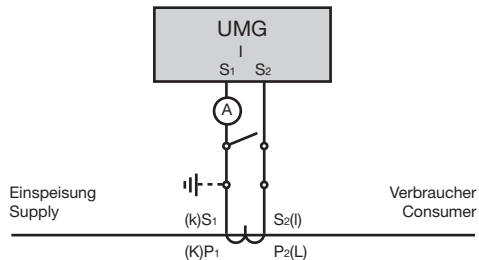

Fig. Current measurement with an additional ammeter (example).

## Total current measurement

If the current measurement is done via two current transformers, the overall transformation ratio of the current transformers must be programmed into the UMG 96RM-PN.

Example: The current is measured via two current transformers. Both current transformers have a transformation ratio of 1000/5A. The summation measurement is performed using a total current transformer 5+5/5A.

The UMG 96RM-PN must then be setup as follows:  
 Primary current:  $1000\text{A} + 1000\text{A} = 2000\text{A}$   
 Secondary current:  $5\text{A}$

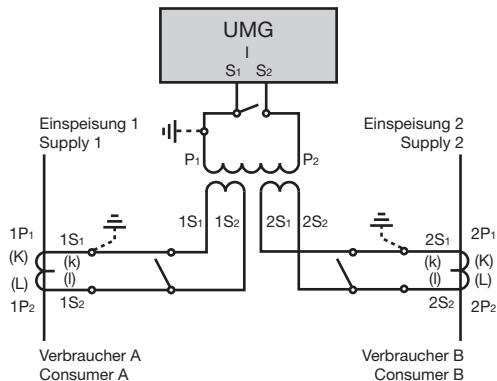

Fig. Current measurement via a total current transformer (example).

## Analogue inputs

The UMG 96RM-PN has two analogue inputs, each of which can be used for a residual current measurement or a temperature measurement. A measurement is performed here via terminals 32-34 (Input 1) and 35-37 (Input 2).

The analogue inputs can be used either for residual current measuring or temperature measuring, per the following table:

Measurement	Terminal
Temperature	32/34 (Input 1) and 35/37 (Input 2)
Residual current	32/33/34 (Input 1) and 35/36/37 (Input 2)



### Attention!

Operating equipment connected to the analogue inputs must feature reinforced or double insulation to the mains supply circuits!

#### *Example - temperature sensor:*

A temperature sensor in close proximity to **non**-isolated mains cables should measure within a 300V CAT III network.

Remedy:

The temperature sensor must be equipped with reinforced or double insulation for 300V CAT III. This equates to a test voltage for the temperature sensor of 3000V AC (duration 1 min.).

#### *Example - residual current transformer:*

A residual current transformer should measure on isolated mains cables within a 300V CAT III network.

Remedy:

The insulation of the mains cables and the insulation of the residual current transformer must fulfil the basic insulation requirements for 300V CAT III. This equates to a test voltage of 1500V AC (duration 1 min.) for the insulated mains cables and a test voltage of 1500 V AC (duration 1 min.) for the residual current transformer.

## Residual current monitoring (RCM) via I5, I6

The UMG 96RM-PN is suitable for use as a residual current monitoring device (RCM) as well as for monitoring AC, pulsing DC, and DC.

The UMG 96RM-PN can measure residual currents in accordance with IEC/TR 60755 (2008-01)

 of type A and

 type B.

The connection of suitable external residual current transformers with a rated current of 30 mA is performed via the residual current transformer inputs I5 (terminals 32-34) and I6 (terminals 35-37).



### Residual current transformer ratio

The GridVis software included in the scope of the delivery can be used to individually program the residual current transformer inputs' transformer ratios.

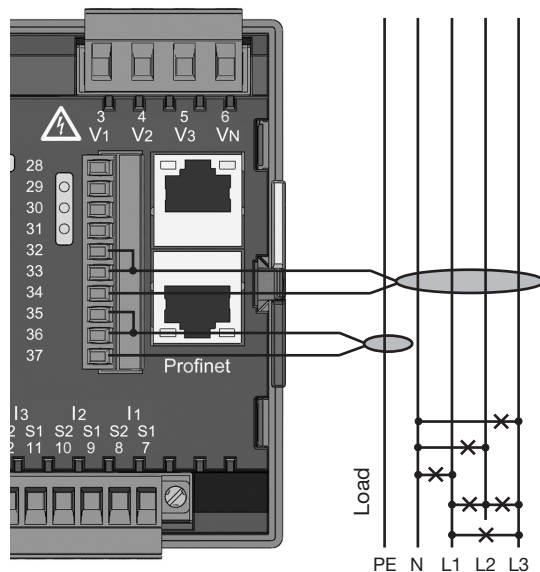

*Fig. Connection example of residual current monitoring via current transformers*

Connection example, residual current monitoring

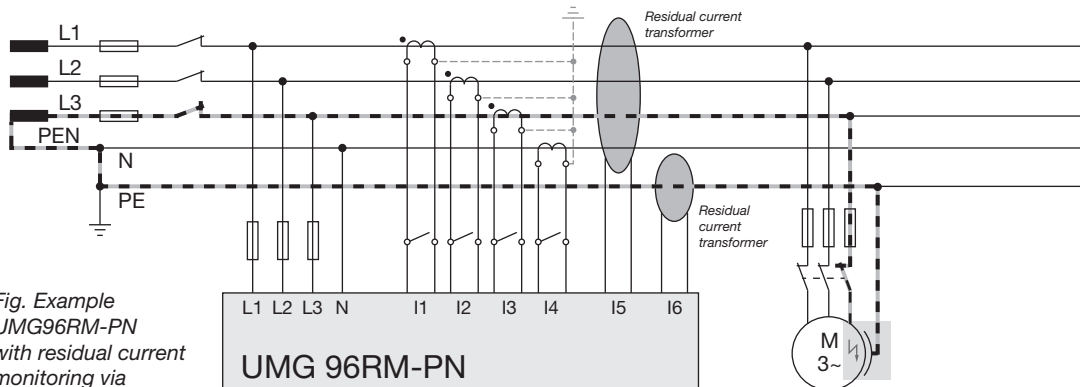

Fig. Example UMG96RM-PN with residual current monitoring via measuring inputs I5/I6.



It is not necessary to configure a connection schematic for measurement inputs I5 and I6!



## Thermistor input

The UMG 96RM-PN has two thermistor inputs. The temperature measurement is performed here via terminals 32/34 (Input 1) and 35/37 (Input 2).

Do not exceed the total resistance load (sensor + cable) of 4kOhm.

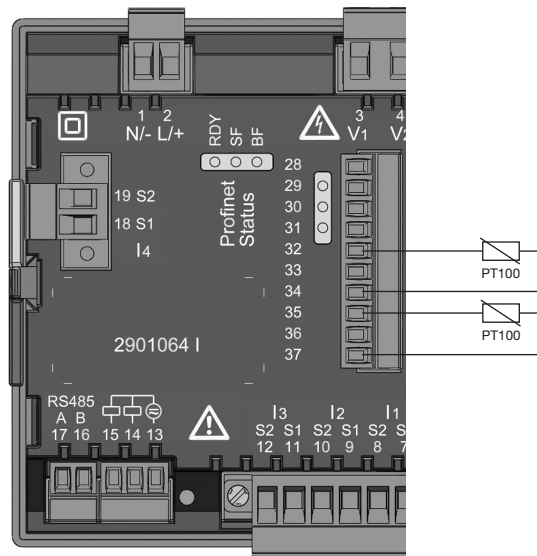

Fig. Example, temperature measurement with a PT100



Use a shielded cable to connect the temperature sensor.

## RS485 interface

On the UMG 96RM-PN, the RS485 interface is designed as a 2-pin plug contact, which communicates via the Modbus RTU protocol (see also Programming parameters).

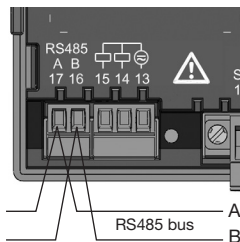

RS485 interface,  
2 pin plug contact

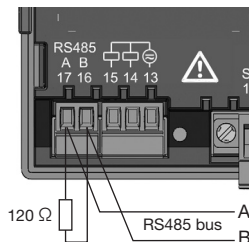

RS485 interface,  
2-pin plug contact with  
termination resistor  
(item no. 52.00.008)

## Termination resistors

The cable is terminated with resistors (120Ohm, 1/4W) at the beginning and at the end of a segment.

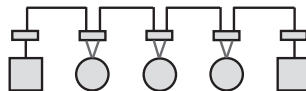

The UMG 96RM-PN does not contain any termination resistors.

### Correct

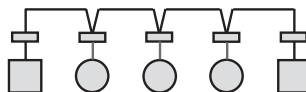

### Incorrect



-  Terminal strip in the cabinet.
-  Device with RS485 interface.  
(without termination resistor)
-  Device with RS485 interface.  
(with termination resistor on the device)

## Screening

Twisted screened cable should be used for connections via the RS485 interface.

- Earth the screens of all cables that lead to the cabinet and at the cabinet entry.
- Connect the screens over a generous area and in a manner that will conduct well, to a low-noise earth.
- Gather the cables mechanically above the earthing clamp in order to avoid damage due to cable movements.
- Use suitable cable glands to feed the cables into the cabinet, for example, armoured conduit couplings.



CAT cables are not suitable for bus wiring. Use the recommended cable types for this.

## Cable type

The cable used must be suitable for an environmental temperature of at least 80°C.

Recommended cable types:

Unitronic Li2YCY(TP) 2x2x0.22 (from Lapp Kabel)

Unitronic BUS L2/FIP 1x2x0.64 (from Lapp Kabel)

## Maximum cable length

1200m at a baud rate of 38.4k.

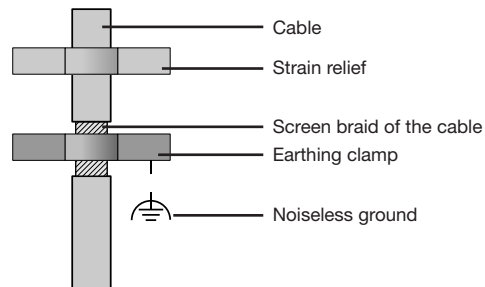

Fig. Screening procedure at cabinet entry.

## Bus structure

- All devices are connected in a bus structure (line) and each device has its own address within the bus (see also Parameter programming).
- Up to 32 subscribers can be connected together in a single segment.
- The cable is terminated with resistors (bus termination 120Ohm, 1/4W) at the beginning and at the end of a segment.
- With more than 32 subscribers, repeaters (amplifiers) must be used to connect the individual segments.
- Devices for which the bus connection is switched on must be under current.
- It is recommended that the master be placed at the end of a segment.
- If the master is replaced with a bus connection, the bus must be switched off.
- Replacing a slave with a bus connection that is either switched on or de-energised can destabilise the bus.
- Devices that are not connected to the bus can be replaced without destabilising the bus.

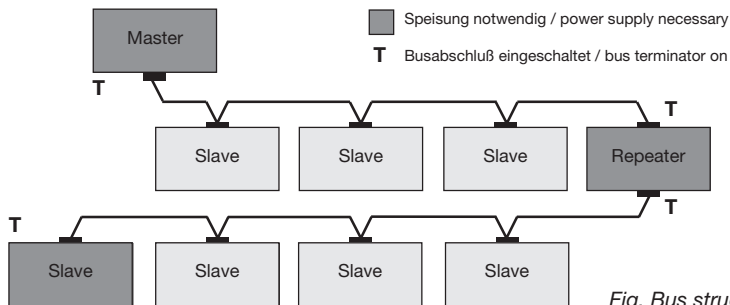
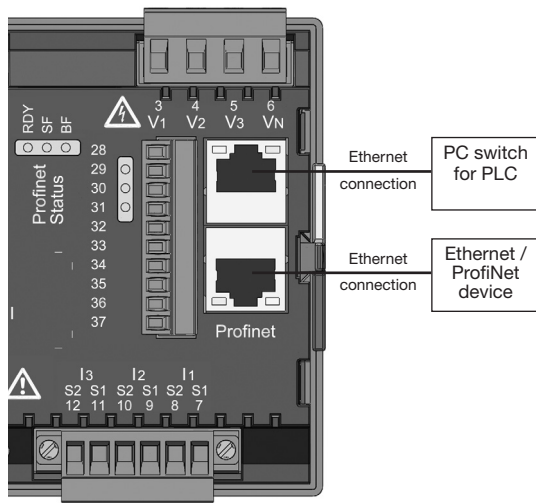

Fig. Bus structure

## Ethernet / ProfiNet interface

The Ethernet network settings should be specified by the network administrator and set on the UMG 96RM-PN accordingly.

If the network settings are not known, the UMG 96RM-PN may not be integrated into the network through the patch cable.



The UMG 96RM-PN has two identical Ethernet interfaces. This allows another Ethernet/ProfiNet terminal to be operated via the second interface, thus reducing outlay on cabling.

LEDs for the Ethernet interfaces

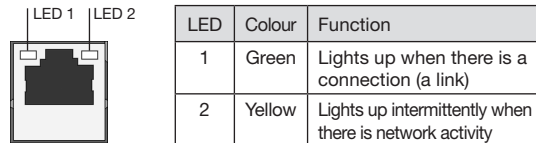

ProfiNet status LED bar

LED	Status	Function
RDY	Off	Device is not powered
RDY	Flashing	Device is being initialised
RDY	On	Device is ready for operation
SF	On	Configuration error or system error
BF	On	No connection
BF	Flashing	No ProfiNet connection, in spite of physical connection
BF	Off	Connection to the PLC established / active



### Attention!

Connection of the UMG96RM-PN to the Ethernet may only be carried out after consulting the network administrator!



**Dynamic Configuration Protocol (DCP)**  
This function assigns unique addresses and names to the subscribers of a ProfiNet system, and is prioritised by the UMG 96RM-PN.

### Device master file

The device master file, abbreviated as GSD file, describes the ProfiNet characteristics of the UMG96RM-PN. The GSD file is required, for example, by the configuration program of the PLC.

The device master file for the UMG96RM-PN has the file name "GSDML-V2.31-JanitzaelectronicsGmbH-UMG96RM-PN-xxxxxxx.xml" and is included on the data carrier as part of the scope of the delivery.

### PROFenergy / Entity Class 2

The UMG 96RM-PN is certified as Entity Class 2 (measurement functionality) for use of the PROFenergy Profile V1.1.



- A *PROFenergy* device provides a defined set of functions and information, helping to standardise and reduce configuration and installation effort.
- *PROFenergy* is a profile for energy management in production systems, which is based on ProfiNet.
- Energy consumers within the system can therefore be controlled and monitored with *PROFenergy* using open and standardised commands.
- With automated comparison of functionality between the ProfiNet control centre and the UMG, additional configuration and installation is rendered unnecessary.

## Digital in-/outputs

The UMG 96RM-PN has 2 digital outputs and either 3 digital inputs or outputs, which are subdivided into two groups (see Figure, page 40). This is based on the rule that only the **whole** of Group 2 (connection 28 to 31) can function either as an input or output; differing assignments within the same group are not possible!

### Digital outputs, Group 1

- The status indicator appears on the display at K1 or K2
- The status indicator on the display is not dependent on an inversion being activated (NC / NO)

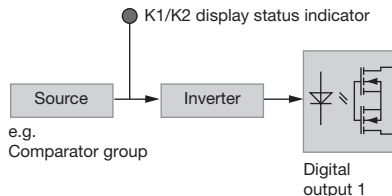

### Digital outputs, Group 2

- The status of the inputs and outputs in Group 2 is indicated by the associated LED (cf. chapter LED status bar).

### Input/output byte coding

(Input/output data of the ProfiNet „digital IO“ module)

- If the digital inputs/outputs in group 2 are configured as inputs, bit-oriented coding of the statuses occurs (bit 0 to 2). In this case, coding corresponds to the digital inputs with:

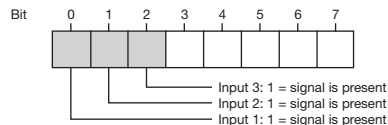

- The digital outputs can be controlled by setting the corresponding bits.
- If, for example, the digital inputs/outputs in group 2 are configured as outputs, bit-oriented coding occurs within bits 0 to 4:

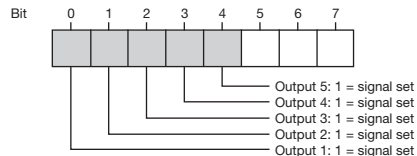

## Digital outputs

These outputs are galvanically separated from the analysis electronics using optocouplers. The digital outputs have a common supply.

- The digital outputs can switch AC and DC loads.
- The digital outputs are **not** short-circuit proof.
- Connected cables that are longer than 30m must be shielded when laid.
- An external auxiliary voltage is required.
- The digital outputs **of Group 1** can be used as pulse outputs.
- The digital outputs can be controlled via Modbus and ProfiNet.
- The digital outputs **of Group 1** can output results of comparators.

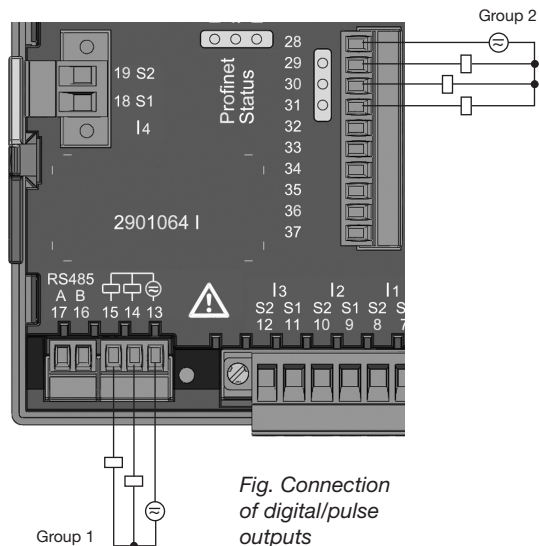

*Fig. Connection of digital/pulse outputs*





### Attention!

Digital outputs are not short-circuit proof!



Functions for the digital outputs can be adjusted clearly in the GridVis software provided in the scope of delivery. A connection between the UMG 96RM-PN and the PC via an interface is required to use the GridVis software.



When using the digital outputs of **Group 1** as pulse outputs, the auxiliary voltage (DC) must have a max. residual ripple of 5%.



The digital inputs or outputs of **Group 2** cannot be configured as pulse inputs/outputs. It is possible to use them as switch inputs/outputs (ProfiNet/Modbus, tariff switching).

### Example DC connection

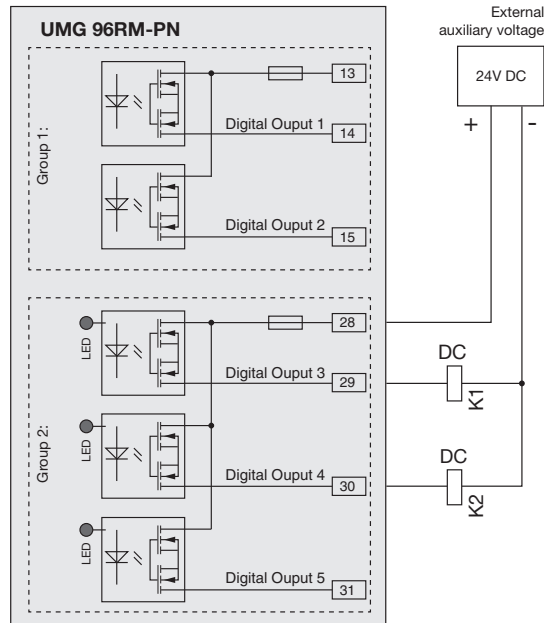

Fig. Example for two relays connected to the digital outputs

## Digital inputs

When Group 2 is assigned as inputs, the UMG96 RM-PN has three digital inputs, each of which can have a signal generator connected to it. If there is a signal, the associated LED lights up green.

An input signal is detected on a digital input if a voltage of at least 10V and maximum 28V is applied and a current of at least 1mA and a maximum of 6mA is flowing. Wiring longer than 30m must be screened.

Note the correct polarity of the supply voltage!

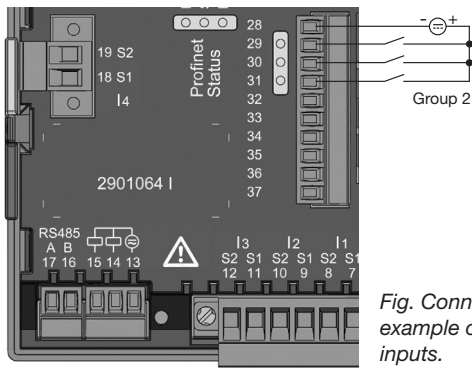

Fig. Connection example of digital inputs.

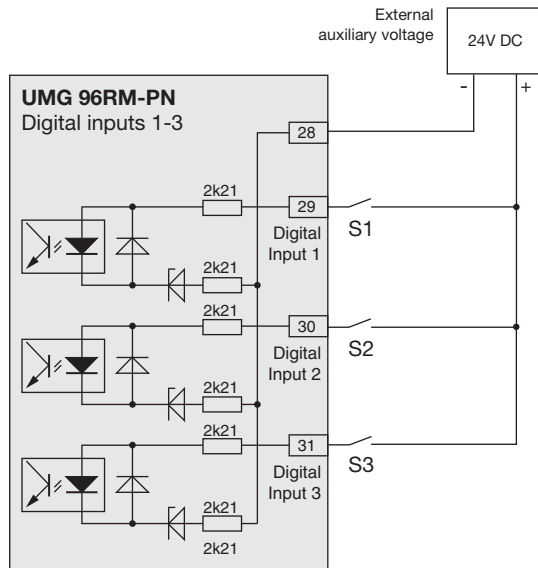

Fig. Example for the connection of external switch contacts S1 and S2 to digital inputs 1 and 2.

## LED status bar

The LED status bar on the back of the device shows the different statuses of the inputs and outputs.

### Digital inputs

The LED assigned to the input lights up **green** if a signal of at least 1mA is flowing on this interface.

### Digital outputs

The LED assigned to the output lights up **red** if the output is set as active - irrespective of whether there is an onwards connection to this interface.

Digital input/output 1/3  
Digital input/output 2/4  
Digital input/output 3/5

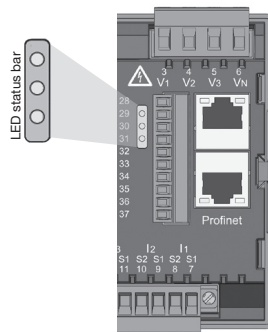

Fig. LED status bar for the inputs or outputs



The digital inputs or outputs of **Group 2** cannot be configured as pulse inputs/outputs. It is possible to use them as switch inputs/outputs (ProfiNet/Modbus, tariff switching).

## Operation

The UMG 96RM-PN is operated with buttons 1 and 2, whereby the following distinctions are made:

- short press of button 1 or 2:  
next step (+1)
- long press of button 1 or 2:  
previous step (-1)

Measured values and programming data are presented on a liquid crystal display.

A distinction is made between *Display mode* and *Programming mode*. The requirement to enter a password makes it possible to prevent the programming data from being changed accidentally.

### Display mode

In Display mode, using buttons 1 and 2, you can scroll through the programmed measured value screens. In the factory, all measured value screens listed in Profile 1 can be accessed. Up to three measured values are displayed on each measured value screen. The measured value rotation allows selected measured value screens to be displayed in turn after a configurable rotation time.

## Programming mode

Programming mode displays and allows for the modification of the settings required for operation of the UMG 96RM-PN. Pressing and holding buttons 1 and 2 at the same time for approx. 1 second takes you (after password prompt) to Programming mode. If no user password has been set up, you are taken directly to the first Programming menu. Programming mode is indicated on screen by the text "PRG".

Button 2 then allows you to switch between the following Programming menus:

- Current transformer
- Voltage transformer
- Parameter list
- Device TCP/IP address
- Subnet mask
- Gateway address

If you are in Programming mode and no button is pressed around 60 seconds or if buttons 1 and 2 are pressed simultaneously for around 1 second, the UMG 96RM-PN returns to Display mode.

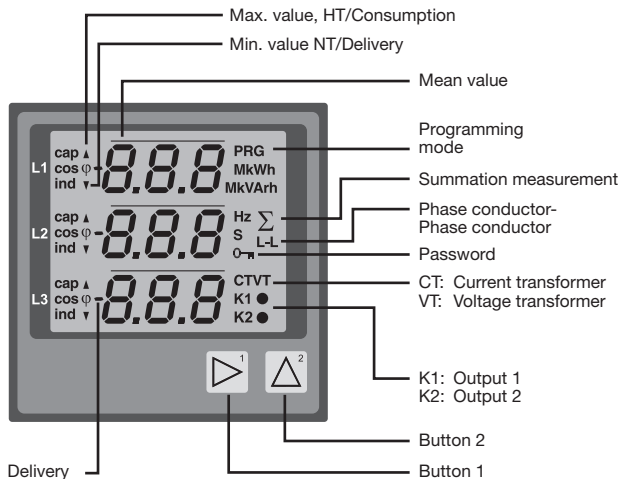

## Parameters and measured values

All of the parameters required for operation of the UMG 96RM-PN, such as the current transformer data, and a selection of frequently required measured values are stored in the table.

The contents of most addresses can be accessed via the serial interface and with the buttons on the UMG 96RM-PN.

On the device you can only enter the first 3 significant digits of a value. Values with more digits can be entered in GridVis.

The device only ever displays the first 3 significant digits of the value.

Selected measured values are summarised in measured value screen profiles, and can be displayed in Display mode with buttons 1 and 2.

The current measured value screen profile, the current screen rotation profile and date and time can only be read and modified via the RS485 interface.

## Example of a parameter screen

On the display of the UMG 96RM-PN the contents of address "000" is displayed as "001". This parameter describes (according to the list) the device address of the UMG 96 RM-PN (in this case "001") within a bus.



## Example of a measured value screen

In this example, the display of the UMG 96RM-PN shows each of the voltages L to N as 230V. Transistor outputs K1 and K2 are active and a current can flow.

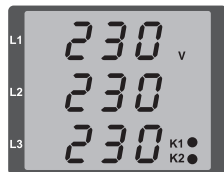

## Button functions

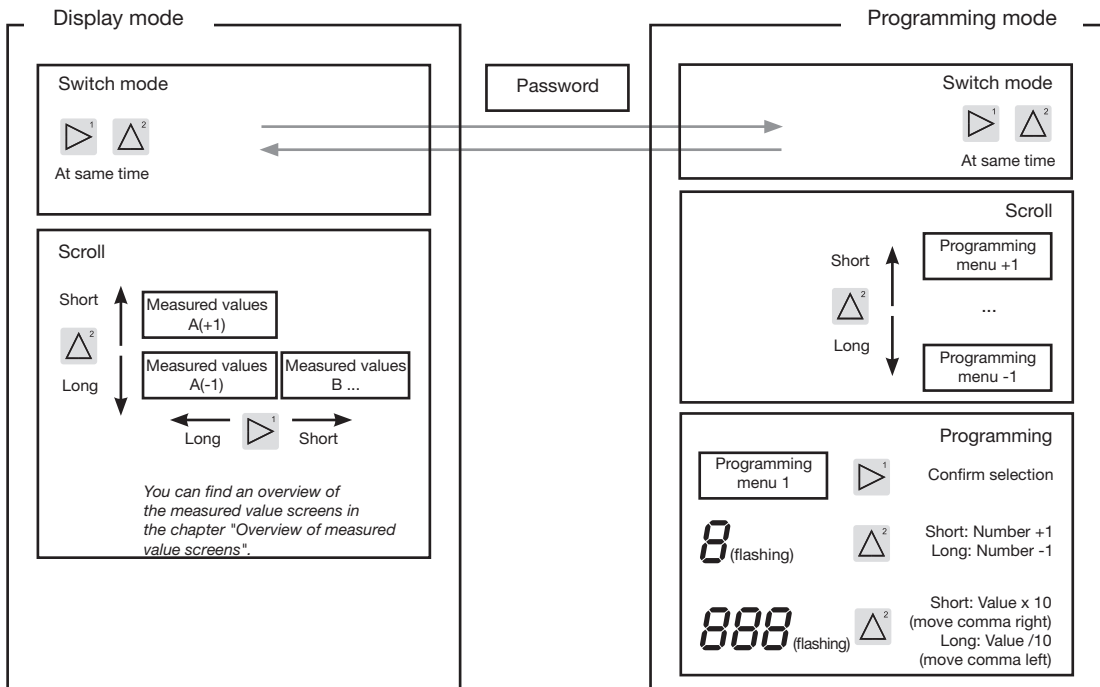

## Configuration

### Connecting the supply voltage

The supply voltage must be connected for the configuration of the UMG 96RM-PN.

The supply voltage level for the UMG 96RM-PN is specified on the rating plate.

If no screen appears, check whether the supply voltage is within the rated voltage range.

### Current and voltage transformer

A current transformer of 5/5A is set in factory. Only if voltage transformers are connected does the pre-programmed voltage transformer ratio need modifying.

When connecting voltage transformers, pay attention to the measured voltage specified on the rating plate of the UMG 96RM-PN!



#### Attention!

If the supply voltage does not correspond to the voltage indicated on the rating plate, this may lead to malfunctions and severe damage to the device.



The adjustable value 0 for the primary current transformer does not produce any meaningful work values, and must not be used.



Devices based on automatic frequency detection require approx. 5 seconds to determine the mains frequency. During this time, the measured values do not comply with the promised measurement uncertainty.



Prior to commissioning potential production dependant contents of the energy counter and min/max values have to be deleted.





## Current and voltage transformer

The GridVis software included in the scope of the delivery can be used to individually program the transformation ratios for each current or voltage measurement input.

Only the transformation ratio for the respective group of current measurement inputs I1-I3 or voltage measurement inputs V1-V3 can be set on the device.

The transformation ratio of *current transformer input I4* and the *residual current transformer inputs I5, I6* must be set in the GridVis software.

### Current transformer input I4

Current transformer input I4 only produces an apparent current measurement, due to there being no multiplier with a voltage. Power measurements with the input are therefore not possible. The transformation ratio can be set in the GridVis software.

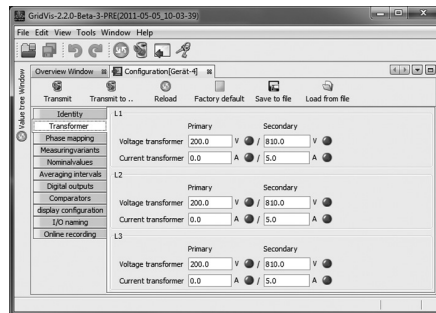

Fig. Screen for configuration of the current and voltage transformer in the GridVis software.

If the device is operated within a PROFINET environment, parameters listed in the GSD file can also be configured via the PLC.

### Programming the current transformer for I1-I3

Switch to Programming mode:

- Switching to Programming mode is done by pressing buttons 1 and 2 simultaneously. If a user password has been set, then the password prompt appears with "000". The first digit of the user password flashes and can be modified with button 2. Pressing button 2 selects the next digit (it starts flashing). If the correct combination of number has been entered or if no user password was set, you are taken to Programming mode.
- The symbols for Programming mode "PRG", and for the current transformer "CT" appear.
- The selection is confirmed with button 1.
- The first digit of the input range for the primary current flashes.

Enter the current transformer primary current:

- Modify the flashing digit with button 2.
- Use button 1 to select the next number you wish to modify. The selected digit to be modified flashes. If the entire number flashes, the decimal point can be moved with button 2.

Enter the current transformer secondary current:

- Only 1A or 5A can be set as the secondary current.
- Use button 1 to select the secondary current.
- Modify the flashing digit with button 2.

Exit Programming mode:

- Exit Programming mode by pressing button 1 and 2 at the same time.

## Programming the voltage transformer

- Switch to programming mode as described. The symbols for Programming mode "PRG", and for the current transformer "CT" appear.
- Button 2 is used to switch to the Voltage transformer settings.
- The selection is confirmed with button 1.
- The first digit of the input range for the primary voltage flashes. The same as assigning the current transformer ratio from the primary to the secondary current, the ratio can be set from the primary to the secondary voltage of the voltage transformer.

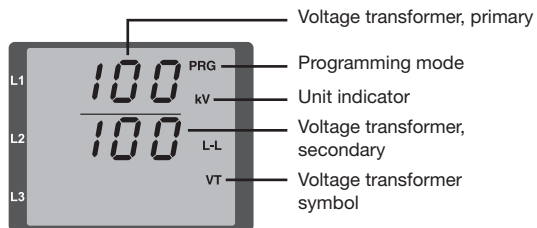
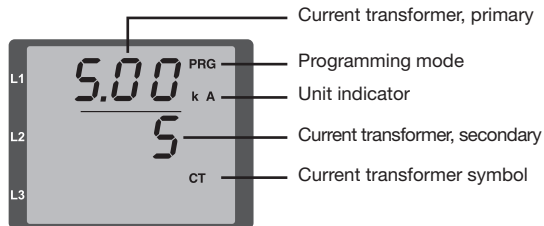

## Programming parameters

Switch to Programming mode

- Switch to programming mode as described. The symbols for Programming mode "PRG", and for the current transformer "CT" appear.
- Button 2 is used to switch to the Voltage transformer settings. Repeatedly pressing button 2 displays the first parameter in the parameter list.

Modify a parameter

- Confirm the select with button 1.
- The last selected address is displayed with the associated value.
- The first digit of the address flashes and can be modified with button 2. Button 1 is used to select the digit, which is then in turn modified with button 2.

Modify a value

- Once the desired address has been set, a digit of the value can be selected with button 1 and modified with button 2.

Exit Programming mode

- Exit Programming mode by pressing button 1 and 2 at the same time.



*Fig. Password prompt*  
If a password was set, it can be entered with buttons 1 and 2.



*Fig. Current transformer programming mode*  
Buttons 1 and 2 can be used to modify the primary and secondary current (cf. page 50).



*Fig. Voltage transformer programming mode*  
Buttons 1 and 2 can be used to modify the primary and secondary voltage (cf. page 51).



*Fig. Parameter screen programming mode*  
Buttons 1 and 2 can be used to modify the individual parameters (cf. page 46).

## TCP/IP configuration

Each device in an Ethernet has a unique TCP/IP address, which can be assigned manually for the UMG 96RM-PN. The 4-byte-long device address (Byte 0 to 3) is appended within the TCP/IP configuration with the subnet mask and gateway details.

If the device is integrated into a ProfiNet environment, however, the address is generally assigned by the DCP function.

Set the device's TCP/IP address (addr)

- Switch to programming mode as described. The symbols for Programming mode "PRG", and for the current transformer "CT" appear.
- Pressing button 2 three times takes you to the TCP/IP settings for device addressing.
- Select the desired digit using button 1. Selection is indicated by the digit flashing.
- The selected digit can be adjusted with the 2 button.
- Use button 1 to select the next digit and set it with button 2 again.
- Once Byte 0 of the TCP/IP address is set, bytes 1 to 3 of the address can be set with button 1. Then the display jumps back to Byte 0 (**none** of the digits are flashing).

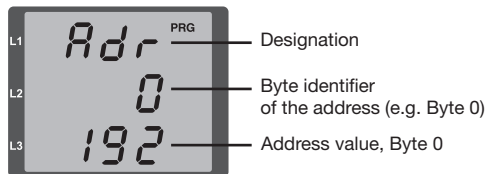

*Fig. TCP/IP address, Byte 1*  
A TCP/IP address consists of 4 bytes with the following structure:



Example: 192.168.003.177



*Fig. TCP/IP address  
Byte 2, value 003*

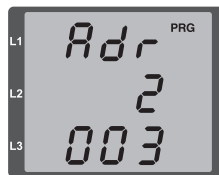

*Fig. TCP/IP address  
Byte 3, value 177*



Set the subnet mask (SUB):

- In programming mode, button 2 takes you to the Subnet mask settings (SUB on screen).
- Use the button 1 to select the desired digit and set it with button 2. Repeat this step for every digit in Byte 0 to 3, the same as when setting the device's TCP/IP address.
- Once the display returns to Byte 0 (**none** of the digits flashing) you can set the gateway.

Set the gateway address (GAT):

- In programming mode, button 2 takes you to the Gateway address settings (GAT on screen).
- Use the 1 and 2 buttons to set the desired gateway address in Byte 0 to 3, in the same way as the above descriptions.

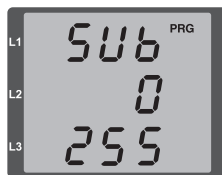

*Fig. Subnet mask (SUB),  
Byte 0, value 255*



*Fig. Gateway (GAT),  
Byte 0, value 192*



#### **Attention!**

Connection of the UMG96RM-PN to the Ethernet may only be carried out after consulting the network administrator!



**Dynamic Configuration Protocol (DCP)**  
This function assigns unique addresses and names to the subscribers of a ProfiNet system, and is prioritised by the UMG 96RM-PN.



Changes are only applied after exiting programming mode.

**RS485 device address (addr. 000)**

If multiple devices are connected together via the RS485 interface, then a Master device is only able to distinguish between these devices based on their device address. Therefore each device on a network must have a different device address. Addresses can be set in the range from 1 to 247.



The setting range for the device address is between 0 and 255. The values 0 and 248 to 255 are reserved and must not be used.

**RS485 baud rate (addr. 001)**

A common baud rate can be set for the RS485 interfaces. A common baud rate must be selected in the network. Address 003 can be used to set the number of stop bits (0=1Bit, 1=2Bits). Data Bits (8) and parity (none) are preset to fixed values.

Setting	Baud rate
0	9.6 kbps
1	19.2 kbps
2	38.4 kbps
3	57.6 kbps
4	115.2 kbps (factory setting)

## User password (addr. 050)

To make it harder to accidentally modify the programming data, a user password can be set. You can only switch to the following Programming menus after entering the correct user password.

No user password is set in the factory. In this case, the Password menu is skipped and you are taken immediately to the Current transformer menu.

If a user password has been set, then the Password menu appears with "000" on the screen.

The first digit of the user password flashes and can be modified with button 2. Pressing button 1 selects the next digit (it starts flashing).

Only when the right combination of numbers is entered, takes you to the Programming menu for the current transformer.

## Forgot password

If you no longer remember your password, you can only delete it using the GridVis PC software.

In order to do so, connect the UMG96RM-PN to the PC with a suitable interface. More information can be found in the GridVis assistant.



## Parameters

### Mean value

Averages for the current, voltage, and power measured values are calculated over an adjustable period. The averages are identified by a bar over the top of the measured value.

The averaging time can be selected from a list of 9 fixed averaging times.

**Current averaging time (addr. 040)**

**Power averaging time (addr. 041)**

**Voltage averaging time (addr. 042)**

Setting	Averaging time/Sec.
0	5
1	10
2	15
3	30
4	60
5	300
6	480 (factory setting)
7	600
8	900

### Averaging method

The used exponential averaging method achieves at least 95% of the measured value after the set averaging time.

### Min. and max. values

All measured values are measured and calculated every 10/12 periods. Min. and max. values are determined for most measured values.

The min. value is the lowest measured value measured since the last time the values were cleared. The min. value is the lowest value measured since the last time the values were cleared. All min. and max. values are compared with the associated measured values, and overwritten if the value is under the min. value or over the max. value.

The min. and max. values are stored every 5 minutes to an EEPROM without the date and time. This means that, if there is failure of the supply voltage, only the min. and max. values for the last 5 minutes can be lost.

### Clearing the min. and max. values (addr.506)

If "001" is written to address 506, all min. and max. values are cleared simultaneously.

### Mains frequency (addr. 034)

To automatically determine the mains frequency, a voltage L1-N of greater than 10Veff must be applied to voltage measurement input V1.

The sampling rate for the current and voltage inputs is then calculated from the mains frequency.

If the measured voltage is absent, it is not possible to determine the mains frequency, which makes it impossible to calculate the sampling rate. The acknowledgeable error message "500" appears.

Voltage, current, and all other values derived from these are calculated and still displayed based on the last frequency measurement or on possible line interfaces. However, these determined measured values are no longer subject to the specified level of accuracy.

Once the frequency can be measured again, the error message disappears automatically approx. 5 seconds after the voltage returns.

The error is not displayed if a fixed frequency is set.

Setting range: 0, 45 - 65

0 = Frequency determined automatically

The mains frequency is determined from the measured voltage.

45 - 65 = Fixed frequency

The mains frequency is preset to a fixed value.

## Power meters

The UMG 96RM-PN has power meters for effective energy, reactive energy, and apparent energy.

## Resetting energy meters (addr. 507)

The effective, apparent, and reactive energy meters can only be reset as one.

To reset the energy meters, address 507 must be described with "001".

## Reading off the effective energy

Total effective energy

The effective energy shown in this example is:  
12 345 678 kWh

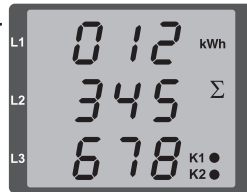

The effective energy shown in this example is:  
134 178 kWh

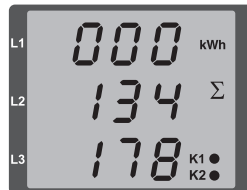

Prior to commissioning potential production dependant contents of the energy counter and min/max values have to be deleted.

Resetting the power meters discards the data in the device. To avoid possible data loss, you should read out and store these measured values with the GridVis software.

## Harmonics

Harmonics are the integer multiples of a fundamental oscillation.

On the UMG 96RM-PN the fundamental oscillation of the voltage must be in the range from 45 to 65 Hz. At this fundamental oscillation the calculated harmonics relate to the voltages and currents.

Harmonics up to 40 times the fundamental oscillation are captured.

The harmonics for the currents are given in amps, the harmonics for the voltages in volts.

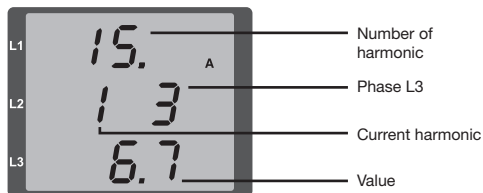

Fig. Screen for the 15th harmonic of the current in phase L3 (example).



Harmonics are not displayed in the factory default setting.

## Total Harmonic Distortion (THD)

THD is the ratio of the effective value of the harmonics to the effective value of the fundamental oscillation.

Total harmonic distortion of the current (THDI):

$$THD_I = \frac{1}{|I_{fund}|} \sqrt{\sum_{n=2}^M |I_{n,Harm}|^2}$$

Total harmonic distortion of the voltage (THDU):

$$THD_U = \frac{1}{|U_{fund}|} \sqrt{\sum_{n=2}^M |U_{n,Harm}|^2}$$

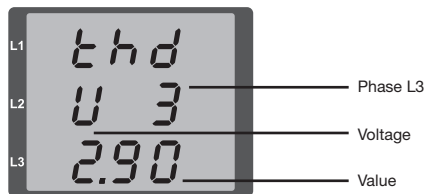

Fig. Screen for the Total harmonic distortion (THD) of the voltage from phase L3 (example).

## Measured value rotation

All measured values are calculated every 10/12 periods, and are available once a second in the measured value screens. Two methods are available for bringing up the measured value screens:

- The automatically rotating display of selected measured value screens, referred to here as "measured value rotation".
- Choosing a measured value screen from a selected screen profile, using buttons 1 and 2.

Both methods are available simultaneously. Measured value rotation is active when at least one measured value screen is programmed with a rotation time greater than 0 seconds.

Pressing a button allows you to scroll through the measured value screens for the selected screen profile. If no button is pressed for around 60 seconds, the device switches to measured value rotation, and the measured values from the selected screen rotation profile programmed measured value screens are displayed in succession.

## Rotation time (addr. 039)

Setting range: 0 to 60 seconds

If 0 seconds is set, then there is no rotation between the measured value screens selected for measured value rotation.

The rotation time applies to all screen rotation profiles.

## Screen rotation profile (addr. 038)

Setting range: 0 to 3

0 - Screen rotation profile 1, preassigned.

1 - Screen rotation profile 2, preassigned.

2 - Screen rotation profile 3, preassigned.

3 - Screen rotation profile, customer-specific.

## Measured value screens

After the power is restored, the UMG 96RM-PN displays the first measured value table from the current screen profile. So that the selection of measured values to be displayed remains clear, at the factory only one part of the available measured values is pre-programmed to be called up in the measured value screen. If you desire to display other measured values on the screen of the UMG 96RM-PN, select a different screen profile.

## Screen profile (addr. 037)

Setting range: 0 to 3

- 0 - Screen profile 1, fixed preassigned value.
- 1 - Screen profile 2, fixed preassigned value.
- 2 - Screen profile 3, fixed preassigned value.
- 3 - Screen profile, customer-specific.



The customer-specific profiles (screen rotation profile and screen profile) can only be programmed via the GridVis software.



### Profile setting

The enclosed GridVis software provides a clear overview of the profiles (screen rotation profile and screen profile). In the software the Device configuration can be used to configure the profiles; customer-specific screen profiles can also be programmed. A connection between the UMG 96RM-PN and the PC is required to use the GridVis software.

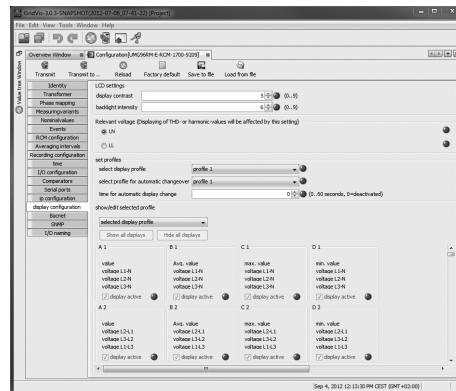

Fig. Profile setting screen in the GridVis software.

## Direction of the rotating field

The direction of the rotating field of the voltages and the frequency of phase L1 are displayed in a screen.

The direction of the rotating field specifies the phase sequence in three-phase power grids. A “right-hand rotation field” usually exists.

In the UMG 96RM-PN, the phase sequence is tested and indicated on the voltage measurement inputs. A movement of the character string in a clockwise direction means there is a “right-hand rotation field” and an anticlockwise movement indicates a “left-hand rotation field”.

The direction of the rotating field is only determined when the measuring and supply voltage inputs are fully connected. If a phase is missing or if two identical phases are connected, the direction of the rotating field is not established and the character string is stationary on the screen.



*Fig. Screen for the mains frequency (50.0) and the direction of the rotating field.*



*Fig. Direction of the rotating field not detectable.*

## LCD contrast (addr. 035)

The preferred direction for observing the LCD display is from below. The contrast of the LCD display can be adjusted by the user. The contrast can be set in the range from 0 to 9 in steps of 1.

0 = Characters very bright

9 = Characters very dark

Factory default setting: 5

## Backlight

The backlight enables good legibility of the LCD display under poor visual conditions. The brightness can be controlled by the user in the range from 0 to 9 in steps of 1.

The UMG 96RM-PN has two different types of backlight:

- Operating lighting
- Standby lighting

### Operating lighting (addr. 036):

The operating lighting is activated by the push of a button or upon restart.



### Standby lighting (addr. 747)

This type of backlight is activated after a customisable period of time (addr. 746). If there are no button presses during this period, the device switches to standby lighting.

If buttons 1 - 3 are pressed, the device switches to operating lighting and the defined period begins again from scratch.

If the brightness values are the same for both types of lighting then no change is discernible between the backlight and standby lighting.

Addr.	Description	Setting range	Default
036	Brightness for operating lighting	0 to 9	6
746	After how long to switch to standby lighting	60 to 9999 secs	900 secs
747	Brightness for standby lighting	0 to 9	0

0 = Minimum brightness, 9 = Maximum brightness

DCP "Identify Station" signal of the PLC:  
If the PLC sends control signals for device identification to the device, the backlight switches between maximum and minimum brightness (causing the display lighting to "flash"). To achieve this there is usually a "Flash" button in the PLC.



## Time logging

The UMG 96RM-PN logs the operating hours and the total running time of each comparator, whereby the time

- for the operating hours is measured with a resolution of 0.1 hrs and displayed in hours or
- the total running time of the comparators is displayed in seconds (when 999,999 secs is reached, the number is displayed in hours).

For a query using the measured value screens, the times are indicated with the numbers 1 to 6:

None = Operating hours counter

1 = Total running time, Comparator 1A

2 = Total running time, Comparator 2A

3 = Total running time, Comparator 1B

4 = Total running time, Comparator 2B

5 = Total running time, Comparator 1C

6 = Total running time, Comparator 2C

A maximum of 99,999.9 hrs (=11.4 years) can be shown on the measured value screen.

## Operating hours counter

The operating hours counter measures the time in which the UMG 96RM-PN captures and displays measured values. The time for the operating hours is measured with a resolution of 0.1 hrs and displayed in hours. The operating hours counter cannot be reset.

## Total running time, comparator

The total running time of a comparator is the sum of all times for which there was a threshold value violation in the comparator result.

The total running times of the comparators can only be reset via the GridVis software. The reset is performed for all total running times.



*Fig. Measured value screen  
Operating hours counter*

*The UMG 96RM-PN shows the number 140.8 hrs in the operating hours counter. This corresponds to 140 hours and 80 industry minutes. 100 industry minutes correspond to 60 minutes. In this example, the 80 industry minutes correspond to 48 minutes.*

**Serial number (addr. 754)**

The serial number displayed by the UMG 96RM-PN has six digits and is a part of the serial number displayed on the rating plate.

The serial number cannot be modified.

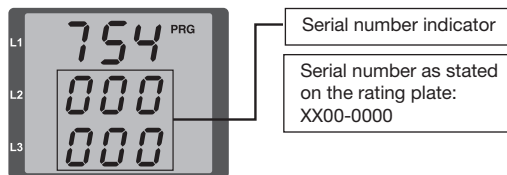
**Software release (addr. 750)**

The software for the UMG 96RM-PN is continuously improved and expanded. The software version in the device is identified by a three-digit number, the software release. The software release cannot be modified by the user.



## Commissioning

### Connecting the supply voltage

- The supply voltage level for the UMG 96RM-PN is specified on the rating plate.
- After applying the supply voltage, the UMG 96RM switches to the first measured value screen.
- If no display appears, check whether the power supply voltage is within the rated voltage range.

### Connecting the measured voltage

- Measurement of voltages in networks with over 300VAC to earth must be connected via voltage transformers.
- After connecting the measured voltages, the measured values displayed by the UMG 96RM-PN for the L-N and L-L voltages must correspond to those at the voltage measurement input.



#### Attention!

Voltages and currents that are outside the permissible measurement range can cause personal injury and lead to the destruction of the device.

### Applying the measuring-circuit voltage

The UMG 96RM-PN is designed for the connection of .. /1A and .. /5A current transformers.

Only AC currents can be measured via the current measurement inputs - DC currents cannot.

Short circuit all current transformer outputs except for one. Compare the currents displayed by the UMG 96RM with the applied current.

Bearing in mind the current transformer conversion ratio, the current displayed by the UMG 96RM-PN must correspond with the input current.

The UMG 96RM-PN must display approx. zero amperes in the short circuited current measurement inputs.

The current transformer ratio is factory-set to 5/5A and must be adapted to the current transformer used if necessary.



#### Attention!

If the supply voltage does not correspond to the voltage indicated on the rating plate, this may lead to malfunctions and severe damage to the device.



#### Attention!

The UMG 96RM is not suitable for measuring DC voltages.

### Direction of the rotating field

Check the direction of the rotating field voltage in the measured value display of the UMG 96RM. A “right-hand” rotation field usually exists.

### Checking the phase assignment

The phase conductor assignment to the current transformer is correct if a current transformer is short-circuited on the secondary side and the current displayed by the UMG 96RM-PN drops to 0A in the associated phase.

### Checking the power measurement

Short-circuit all current transformer outputs except for one and check the displayed power outputs.

The UMG 96RM-PN may only display one power output in the phase with a non-short-circuited current transformer input. If this is not the case, check the connection of the measured voltage and the measuring-circuit current.

If the effective power amount is correct but the sign of the power output is negative, this could have two possible causes:

- S1(k) and S2(l) are reversed at the current transformer.
- Effective energy is being supplied back into the network.

### Applying the residual current

Connect residual current transformer only to the I5 and I6 inputs with a rated current of 30mA! Both residual current inputs can measure AC currents, pulsing direct currents and DC currents.

Bearing in mind the current transformer ratio, the residual current displayed by the UMG96RM-PN must correspond with the input current.

The current transformer ratio is factory-set to 1/1A and must be adapted to the residual current transformer used if necessary.



The UMG96RM-PN requires the mains frequency for residual current monitoring. For this purpose, the measured voltage should be applied or a fixed frequency should be set.



It is not necessary to configure a connection schematic for residual current inputs I5 and I6.

## Failure monitoring (RCM) for I5, I6

The UMG96RM-PN enables continuous monitoring of the connection to the residual current transformer on inputs I5 and I6.

Modbus addr.	Value / Function
553 (I5) 554 (I6)	0 = Transformer monitoring, I5 and I6 deactivated 1 = Transformer monitoring, I5 and I6 activated

If there is an interruption in the connection to the current transformer, this state is recorded in certain registers or indicated in the GridVis software:

Modbus addr.	Value / Function
10014 (I5) 10015 (I6)	0 = Connection of the residual current transformer to I5 and I6 error-free 1 = Error in the current transformer connection to I5 and I6



The monitoring of the connection to the residual current transformer is only available in the AC mode!  
Residual current transformers of Type A must be used for transformer monitoring!



We recommend configuring the residual current measurement settings in GridVis.

### Checking the measurement

Once all voltage and current measurement inputs are properly connected, the signal phase and sum powers are also calculated and displayed properly.

### Checking the single phase powers

If a current transformer is assigned to the wrong phase conductor, the associated power will also be measured and displayed incorrectly.

The assignment of phase conductor to current transformer on the UMG 96RM-PN is correct when there is no voltage between the phase conductor and the associated current transformer (primary).

To ensure that a phase conductor on the voltage measurement input is assigned to the right current transformer, you can short-circuit the current transformer in question on the secondary side. The apparent power displayed by the UMG 96RM-PN must be zero in this phase.

If the apparent power is displayed correctly but the effective power has a "-" sign, the current transformer terminals are reversed or power is being supplied to the power company.

### Checking the sum powers

If all voltages, currents, and powers for the phase conductor in question are displayed properly, then the sum powers measured by the UMG 96RM must also be correct. For confirmation, the sum powers measured by the UMG 96RM should be compared with the effective and reactive power meter located in the supply.

## RS485 interface

The MODBUS RTU protocol with CRC check on the RS485 interface can be used to access the data from the parameter and the measured value lists.

Address range: 1 to 247

Factory default setting: 1

The device address is factory set to 1 and the baud rate to 115.2 kbps.

### Modbus functions (slave)

04 Read input registers

06 Preset single register

16 (10Hex) Preset multiple registers

23 (17Hex) Read/write 4X registers

The sequence of bytes is high before low byte (Motorola format).

Transmission parameters:

Data bits: 8

Parity: None

Stop bits (UMG 96RM): 2

External stop bits: 1 or 2

Number format: short 16 bit ( $-2^{15}$  to  $2^{15} - 1$ )

float 32 bit (IEEE 754)



Broadcast (address 0) is not supported by the device.



The message length must not exceed 256 bytes.



Example: Reading the L1-N voltage

The L1-N voltage is saved in the measured value list at address 19000. The L1-N voltage is available in the FLOAT format.

Address = 01 is approved as the UMG 96RM-PN device address.

The Query Message appears as follows:

<u>Name</u>	<u>Hex</u>	<u>Note</u>
Device address	01	UMG 96RM, address = 1
Function	03	"Read holding reg."
Start addr. Hi	4A	19000dez = 4A38hex
Start addr. Lo	38	
Ind. Value Hi	00	2dez = 0002hex
Ind. Value Lo	02	
Error check	-	

The "Response" of the UMG96 RM-PN can appear as follows:

<u>Name</u>	<u>Hex</u>	<u>Note</u>
Device address	01	UMG 96RM, address = 1
Function	03	
Byte meter	06	
Data	00	00hex = 00dez
Data	E6	E6hex = 230dez
Error check (CRC)	-	

The L1-N voltage read by address 19000 is 230V.

## Digital outputs

The UMG 96RM-PN has two digital outputs in Group 1. Another three digital outputs can be set in Group 2.

You can optionally assign different functions to the digital outputs.

The settings of the functions in the configuration menu must be made using the GridVis software.

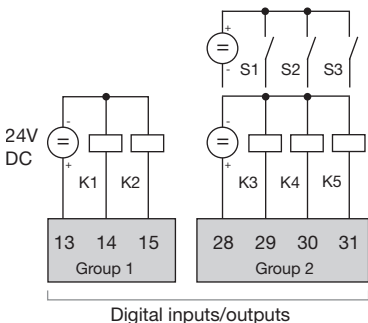

Fig.: Digital outputs of Group 1 and digital inputs/outputs of Group 2

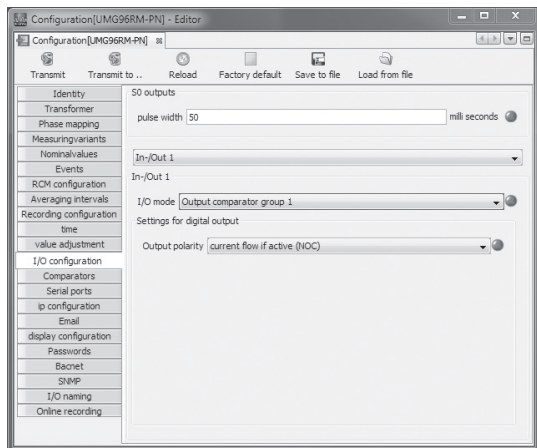

Fig.: GridVis software, configuration menu

## Digital output status indicators

The status of the switch outputs of Group 1 is displayed on the display of the UMG 96RM-PN by circle symbols. Statuses of the digital inputs of Group 2 - as described in the chapter "LED status bar" - are displayed by the rearwards-facing LEDs.



Since the display is only updated once a second, status changes in the outputs which are more rapid than this cannot be displayed.

## Statuses of the digital outputs of Group 1

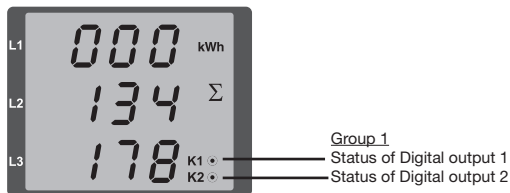

- A current of <math><1\text{mA}</math> can flow.  
Digital output 1: addr. 608 = 0  
Digital output 2: addr. 609 = 0
- A current of up to 50mA can flow.  
Digital output 1: addr. 608 = 1  
Digital output 2: addr. 609 = 1

## Functions of the digital outputs of Group 1

You can optionally assign the following functions to the two digital outputs of Group 1:

### Digital output 1

Addr. 200 = 0	Result of Comparator group 1
Addr. 200 = 1	Pulse output
Addr. 200 = 2	Value from external source Modbus
Addr. 200 = 5	Value from external source Profi

### Digital output 2

Addr. 202 = 0	Result of Comparator group 2
Addr. 202 = 1	Pulse output
Addr. 202 = 2	Value from external source Modbus
Addr. 202 = 2	Value from external source ProfiNet

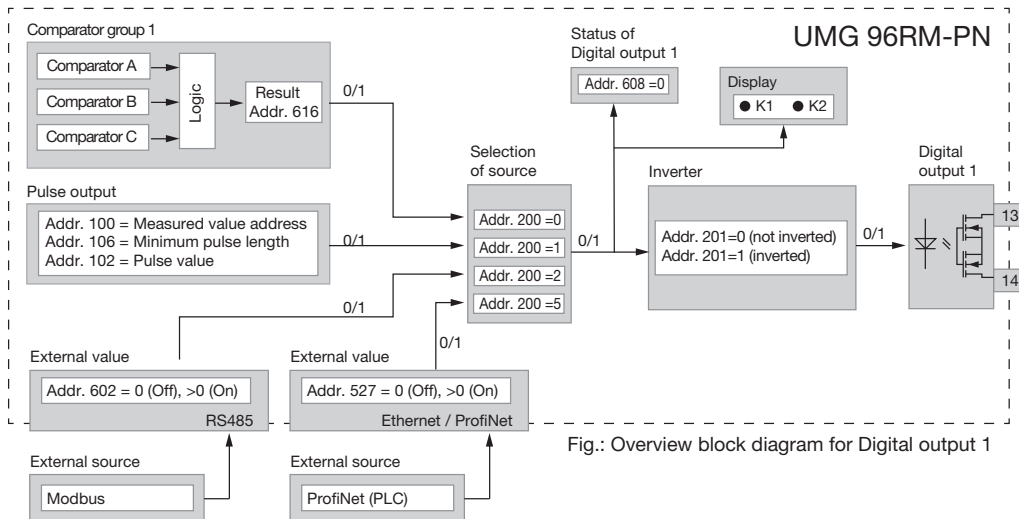

Fig.: Overview block diagram for Digital output 1

## Pulse output (Group 1)

The digital outputs of Group 1 can be used for the output of pulses for the computation of power consumption. For this purpose, a pulse of defined length is applied on the output after reaching a certain, adjustable amount of power.

You need to make various adjustments in the configuration menu using the GridVis software to use a digital output as a pulse out.

- Digital output
- Selection of source
- Measured value selection
- Pulse length
- Pulse value

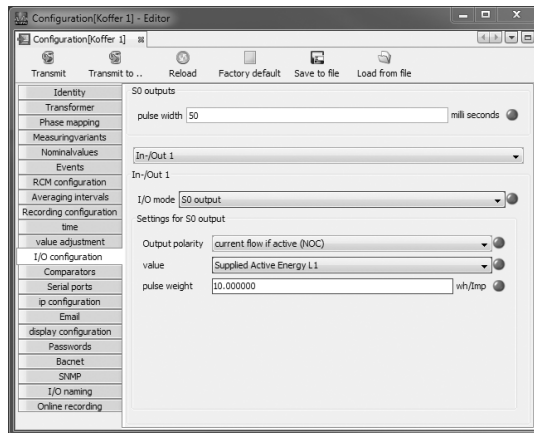

Fig.: GridVis software, configuration menu



The digital outputs of **Group 2** cannot be configured as pulse outputs. Use as switch outputs is possible.

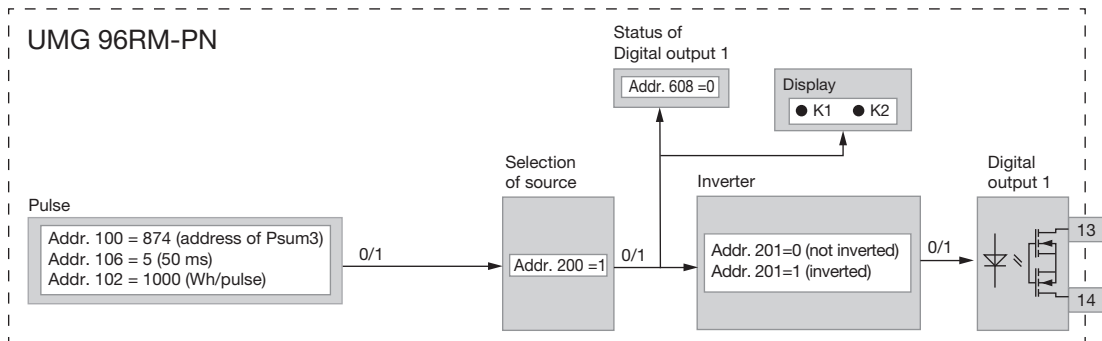

Fig.: Block diagram; example of Digital output 1 as a pulse output.

*Measured value selection (addr. 100, 101):*

Enter the address here for the power value which should be output as the effective pulse. See Table 2.

*Source selection (addr. 200, 202):*

Enter here which source the measured value will supply that should be output on the digital output.

Selectable sources:

- Comparator group
- Pulse
- External source

### *Pulse length (addr. 106):*

The pulse length applies to both pulse outputs and is set using the GridVis software.

The typical pulse length of S0 pulse is 30ms.

### *Pulse interval:*

The pulse interval is at least as large as the selected pulse length.

The pulse interval depends on the measured power, for example, and can take hours or days.

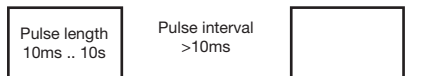

The values in the table are based on the minimum pulse length and the minimum pulse interval for the maximum number of pulses per hour.

Pulse length	Pulse interval	Max. pulse/h
10 ms	10 ms	180 000 pulses/h
30 ms	30 ms	60 000 pulses/h
50 ms	50 ms	36 000 pulses/h
100 ms	100 ms	18 000 pulses/h
500 ms	500 ms	3600 pulses/h
1 s	1 s	1800 pulses/h
10 s	10 s	180 pulses/h

Examples of the maximum possible number of pulses per hour.



#### **Pulse interval**

The pulse interval is proportional to the power output within the selected settings.



#### **Measured value selection**

When programming with GridVis you have a selection of work values which are derived from the power output values.

*Pulse value (addr. 102, 104)*

The pulse value is used to indicate how much power (Wh or varh) should correspond to a pulse.

The pulse value is determined by the maximum connected load and the maximum number of pulses per hour.

If you check the pulse value with a positive sign, the pulses will only be emitted when the measured value has a positive sign.

If you check the pulse value with a negative sign, the pulses will only be produced when the measured value has a negative sign.

$$\text{Pulse value} = \frac{\text{max. connected load}}{\text{max. number of pulses/h}} \quad [\text{Pulse/Wh}]$$



Since the effective energy meter operates with a backstop, pulses will only be generated when drawing electricity.



Since the reactive energy meter operates with a backstop, pulses will only be generated with inductive load applied.



*Determine the pulse value*

Set the pulse length

Set the pulse length in accordance with the requirements of the connected pulse receiver.

At a pulse length of 30 ms, for example, the UMG 96RM generates a maximum number of 60,000 pulses (see Table "maximum number of pulses" per hour.

*Determining the maximum connected load*

Example:

Current transformer = 150/5 A  
 Voltage L-N = Max. 300 V

Power per phase = 150 A x 300 V  
 = 45 kW

Power at 3 phases = 45kW x 3

Maximum connected load = 135 kW

*Calculating the pulse value*

$$\text{Pulse value} = \frac{\text{max. connected load}}{\text{max. number of pulses/h}} \quad [\text{Pulse/Wh}]$$

Pulse value = 135kW / 60,000 Imp/h

Pulse value = 0.00225 pulse/kWh

Pulse value = 2.25 pulses/Wh

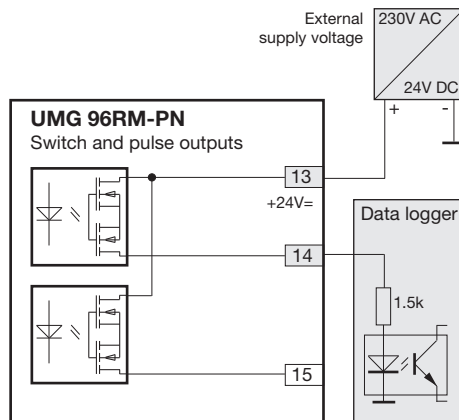

Fig.: Connection example for the circuit as pulse output.



When using the digital outputs as pulse outputs, the auxiliary voltage (DC) must have a max. residual ripple of 5%.

## Comparators and threshold value monitoring

Two comparator groups (1 - 2), each with 3 comparators (A - C) are available to monitor threshold values. The results of Comparators A to C can be combined with the AND/OR operators.

The combination result of Comparator group 1 can be assigned to Digital output 1 and the combination result of Comparator group 2 can be assigned to Digital output 2.

Additionally, the function "Flash display" can also be assigned to each comparator group, whereby the backlight of the screen alternates between maximum and minimum brightness when a comparator output is active.

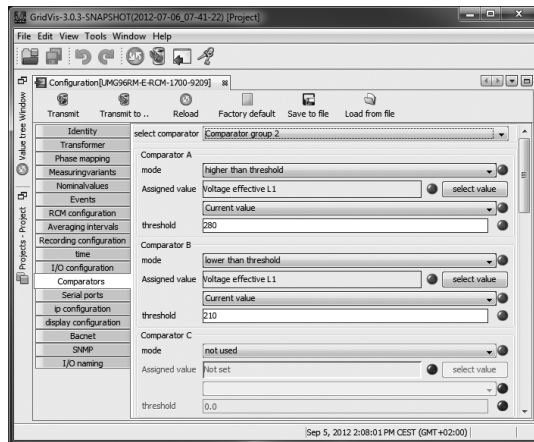

Fig.: GridVis software, configuration menu



The comparator or combination results **cannot** be assigned to the digital outputs of Group 2!



We recommend configuring the comparator and threshold value monitoring settings in GridVis.

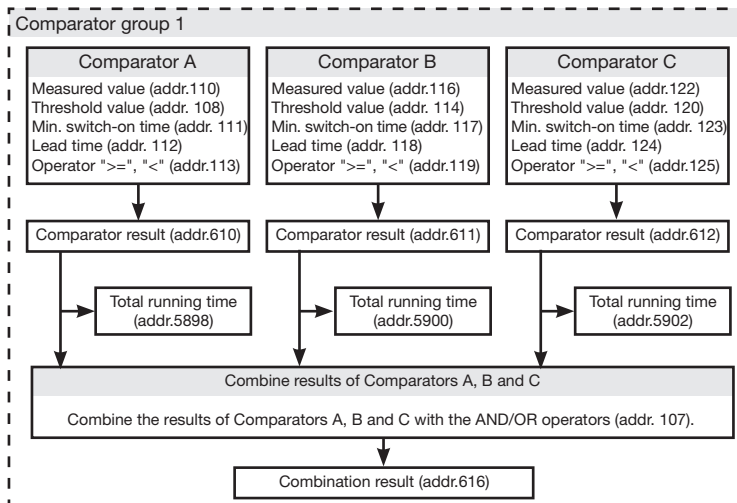

Fig.: Comparator principle of Comparator group 1

### Example: current monitoring on the N

If the current on the N is higher than 100 A for 60 seconds, then Digital output 1 should be active for at least 2 minutes.

The following programming must be undertaken:

1. Comparator group 1

Select Comparator group 1 for threshold value monitoring. The comparator group only has an effect on Digital output 1. Since only one threshold value is being monitored, select Comparator A and program it as follows:

The address of the measured value of Comparator A to be monitored:

Addr. 110 = 866 (address of the current on the N)

The measured values for Comparators B and C are 0.

Addr. 116 = 0 (the comparator is inactive)

Addr. 122 = 0 (the comparator is inactive)

The threshold value to be observed.

Addr. 108 = 100 (100 A)

Digital output 1 should remain active for a min. switch-on time of 2 minutes if the threshold value is exceeded.

Addr. 111 = 120 seconds

The exceedance should be present at least for the lead time of 60 seconds.

Addr. 112 = 60 seconds

The operator for the comparison between measured value and threshold value.

Addr. 113 = 0 (meaning >=)

2. Selection of source

Select Comparator group 1 as the source.

Addr. 200 = 0 (Comparator group 1)

3. Inverter

The result from Comparator group 1 can also be inverted here. However, we will not do so here.

Addr. 201 = 0 (not inverted)

4. Combine the comparators

Comparators B and C were not set and equal zero.

Using the OR operator on Comparators A, B and C, the result of Comparator A is output as the comparator result.

Addr. 107 = 0 (combine with the OR operator)

#### Result

If the current on the N is higher than 100 A for over 60 seconds, then Digital output 1 is active for at least 2 minutes.

Digital output 1 becomes active. A current can flow.

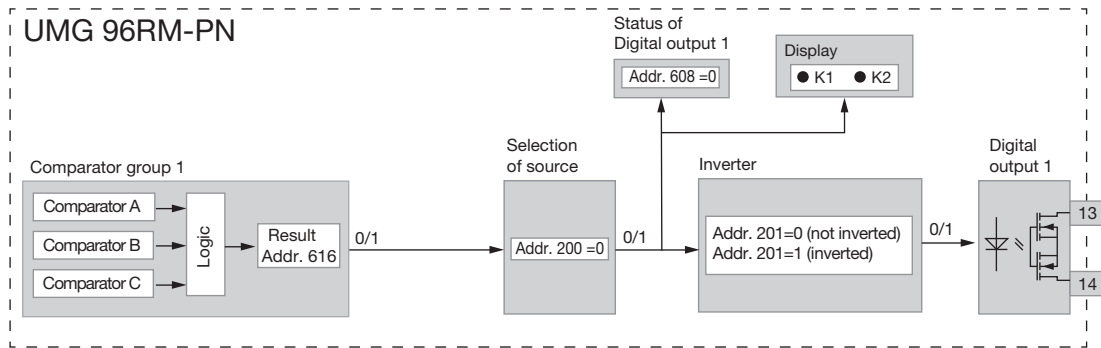

Block diagram: Use of Digital output 1 for threshold value monitoring.



We recommend configuring threshold value monitoring settings in GridVis.



On the UMG 96RM you can only enter 3-digit parameter addresses. Using GridVis you can enter 4-digit parameter addresses.

- **Measured value (addr. 110,116,122,129,135,141)**  
The measured value contains the address of the measured value to be monitored.  
Measured value = 0 the comparator is inactive.
- **Threshold value (addr. 108,114,120,127,133,139)**  
The threshold value is where you write the value to be compared with the measured value.
- **Min. switch-on time (addr. 111,117,123,130,136,142)**  
The logic operation result (e.g. Addr. 610) is retained for the duration of the min. switch-on time.  
Setting range: 1 to 32,000 seconds
- **Lead time (addr. 112,118,124,131,137,143)**  
Only if there is a threshold value violation for at least the duration of the lead time is the comparator result modified.  
The lead time can be assigned to times in the range from 1 to 32,000 seconds.
- **Operator (addr. 113,119,125,132,138,144)**  
Two operators are available for comparing the measured value and the threshold value.  
Operator = 0 means greater than or equal to ( $\geq$ )  
Operator = 1 means less than ( $<$ )
- **Comparator result (addr. 610,611,612,613,614,615)**  
The result of the comparison between the measured value and threshold value is in the comparator result.  
In this context:  
0 = There is no threshold value violation.  
1 = There is a threshold value violation.
- **Total running time**  
The sum of all times for which there was a threshold value violation in the comparator result.
- **Combine (addr. 107,126)**  
Combine the results of Comparators A, B, and C with the AND/OR operators.
- **Total combination result (addr. 616,617)**  
The combined comparator results of Comparators A, B, and C are in the total combination result.

## Comparator running times

Comparator running times are time counters, which are added together at a set comparator output. i.e. if the condition of the comparator is fulfilled and the lead time has elapsed, the counter is increased by the corresponding amount of time - this does not take account of the min. switch-on time!

### Comparator with set limit value violation

- The set limit value is compared to the measured value.
- If the limit value violation occurs for **at least** the duration of the lead time, the comparator result is changed.
- The result is retained for **at least** the duration of the min. switch-on time and for **no longer than** the duration of the limit value violation. If there is no longer a limit value violation and the min. switch-on time has elapsed, the result is reset.

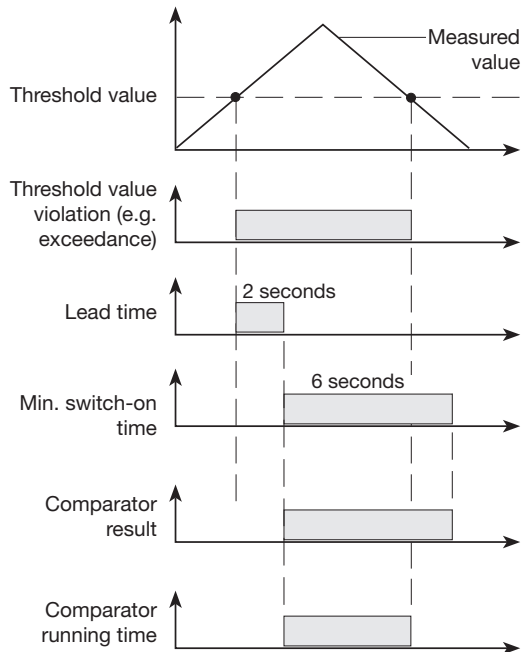

## Service and maintenance

The device underwent various safety checks before delivery and is marked with a seal. If a device is open, then the safety checks must be repeated. Warranty claims will only be accepted if the device is unopened.

### Repair and calibration

Repair work and calibration can be carried out by the manufacturer only.

### Front film

The front film can be cleaned with a soft cloth and standard household cleaning agent. Do not use acids and products containing acid for cleaning.

### Disposal

The UMG 96RM can be reused or recycled as electronic scrap in accordance with the legal provisions. The permanently installed lithium battery must be disposed of separately.

## Service

Should questions arise, which are not described in this manual, please contact the manufacturer directly.

We will need the following information from you to answer any questions:

- Device name (see rating plate),
- Serial number (see rating plate),
- Software release (see measured value display),
- Measured voltage and power supply voltage,
- Precise description of the error.

### Device calibration

The devices are calibrated by the manufacturer at the factory - it is not necessary to recalibrate the device providing that the environmental conditions are complied with.

### Calibration intervals

We recommend having the device recalibrated by the manufacturer or an accredited laboratory every 5 years approximately.



## Firmware update

If the device is connected to a computer, then the device firmware can be updated via the GridVis software.

The new firmware is transferred by selecting a suitable update menu (*Tools/Upgrade Devices* menu) and the device.

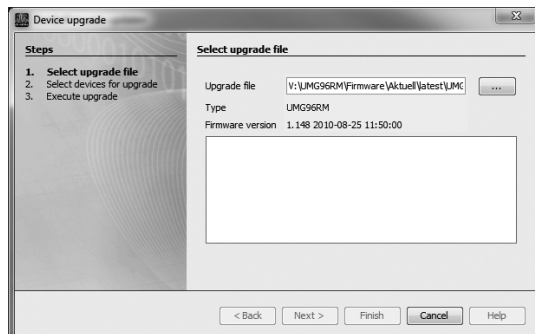

Fig. GridVis firmware update assistant

## Error / warning messages

The UMG 96RM-PN can show four different error messages on the display:

- Warnings
- Serious errors
- Measurement range exceeded

Error messages for warnings and serious errors are depicted with the symbol "EEE" followed by an error number.

The three-digit error number is composed of the error description and - if this can be established by the UMG 96RM - one or more causes for the error.

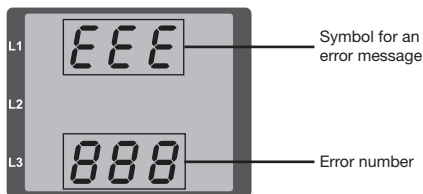

Fig. Error message

## Warnings

Warnings are less serious errors and must be acknowledged with button 1 or 2. The capture and display of measured values continues. This error is displayed again each time the power is switched on.



Fig. Warning message with number 500 (mains frequency)

Error	Error description
EEE 500	<p>The mains frequency could not be established.</p> <p>Possible causes:</p> <ul style="list-style-type: none"> <li>The voltage on L1 is too low.</li> <li>The mains frequency is not in the range from 45 to 65 Hz.</li> </ul> <p>Remedy:</p> <ul style="list-style-type: none"> <li>Check the mains frequency.</li> <li>Select fixed frequency on the device.</li> </ul>

## Serious errors

When a serious error occurs, the device must be sent in to the manufacturer for inspection.

Error	Error description
EEE 910	Error when reading the calibration.

Internal error causes:

In some cases, the UMG 96RM-PN can determine the cause for a serious internal error and report it using the following error codes.

Error	Error description
0x01	EEPROM not responding
0x02	Address below range
0x04	Checksum error
0x08	Error in the internal I2C bus

Example error message 911:

This error number is composed of serious error 910 and the internal error cause 0x01.

In this example an error occurred when reading the calibration from the EEPROM. The device must be sent in to the manufacturer for inspection.



## Measurement range exceeded

If the measurement range is exceeded, it is displayed as long as this persists and cannot be acknowledged. The measurement range is exceeded if at least one of the voltage or current measurement inputs lies outside their specified measurement range.

The Up arrow is used to highlight in which phase the measurement range was exceeded. The corresponding error message for current circuit I4 is as shown in the figure opposite.

The "V" and "A" symbols indicate whether the measurement range has been exceeded in the current or voltage circuit.

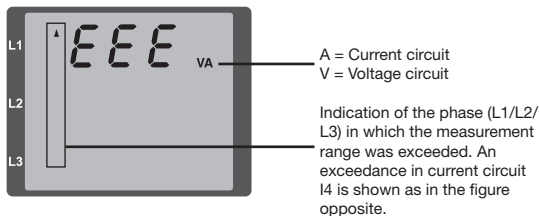

Threshold values for exceeding the measurement range:

$$I = 7 A_{eff}$$

$$U_{L-N} = 520 V_{L-N}$$

## Examples

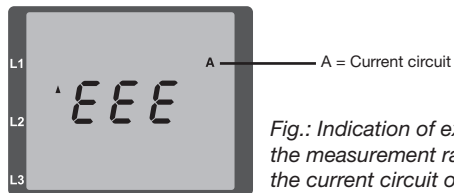

Fig.: Indication of exceeding the measurement range in the current circuit of the 2nd phase (I2).

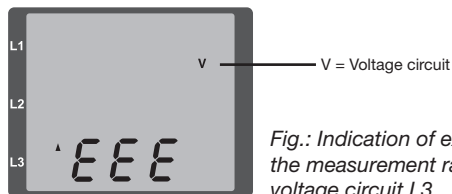

Fig.: Indication of exceeding the measurement range in voltage circuit L3

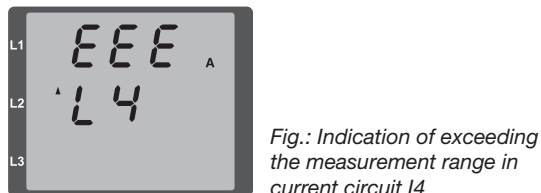

Fig.: Indication of exceeding the measurement range in current circuit I4

### "Measurement range exceeded" parameter

Further description of the error is encoded in the parameter "measurement range exceeded" (addr. 600), stored in the following format:

0x	F	F	F	F	F	F	F	F
Phase 1:	1			1				
Phase 2:	2			2				
Phase 3:	4			4				
Phase 4 (I4):	8			8				
	Current:							
				U <sub>L-N</sub>				

*Example: Error in Phase 2 in the current circuit:*

**0xF2FFFFFF**

*Example: Error in Phase 3 in the voltage circuit U<sub>L-N</sub>:*

**0xFFF4FFFF**

## Procedure in the event of faults

Possible fault	Cause	Remedy
No display	External fuse for the power supply voltage has tripped.	Replace fuse.
No current display	Measured voltage is not connected.	Connect the measured voltage.
	Measurement current is not connected.	Connect measuring-circuit current.
Current displayed is too high or too low.	Current measurement in the wrong phase.	Check connection and correct if necessary.
	Current transformer factor is incorrectly programmed.	Read out and program the CT ratio at the current transformer.
	The current peak value at the measurement input was exceeded by harmonic components.	Install current transformer with a larger CT ratio.
	The current at the measurement input fell short of.	Install current transformer with a smaller current transformer ratio.
Voltage displayed is too high or too low.	Measurement in the wrong phase.	Check connection and correct if necessary.
	Voltage transformer incorrectly programmed.	Read out and program the voltage transformer ratio at the voltage transformer.
Voltage displayed is too low.	Measurement range exceeded.	Use voltage transformers.
	The peak voltage value at the measurement input has been exceeded by the harmonics.	<b>Attention!</b> Ensure the measurement inputs are not overloaded.
Phase shift ind./cap.	A current circuit is assigned to the wrong voltage circuit.	Check connection and correct if necessary.
Effective power, consumption/supply reversed.	At least one current transformer connection is mixed up/reversed.	Check connection and correct if necessary.
	A current circuit is assigned to the wrong voltage circuit.	Check connection and correct if necessary.

Possible fault	Cause	Remedy
Effective power too high or too low.	The programmed CT ratio is incorrect.	Read out and program the CT ratio at the current transformer
	The current circuit is assigned to the wrong voltage circuit.	Check connection and correct if necessary.
	The programmed voltage transformer ratio is incorrect.	Read out and program the voltage transformer ratio at the voltage transformer.
An output is not responding.	The output was incorrectly programmed.	Check the settings and correct if necessary.
	The output was incorrectly connected.	Check connection and correct if necessary.
"EEE" on the display	See error messages.	
No connection with the device.	RS485 - Device address is incorrect - Different bus speeds (baud rate) - Wrong protocol - Termination missing	- Adjust the device address - Adjust speed (baud rate) - Select the correct protocol - Terminate bus with termination resistor
	Ethernet / ProfiNet - IP Device address is incorrect.	- Adjust IP device address.
Device still does not work despite the above measures.	Device defective.	Send the device to the manufacturer for inspection and testing along with an accurate fault description.

## Technical data

General	
Net weight (with attached connectors)	Approx. 380g
Package weight (incl. accessories)	Approx. 780g
Service life of backlight	40,000 hrs (backlighting is reduced by around 50% over this period)

Transport and storage	
The following information applies to devices which are transported or stored in the original packaging.	
Free fall	1m
Temperature	K55 (-25°C to +70°C)
Relative humidity	0 to 90% RH

Ambient conditions during operation	
The UMG 96RM is intended for weather-protected, stationary use. Protection class II in acc. with IEC 60536 (VDE 0106, Part 1).	
Rated temperature range	K55 (-10°C to +55°C)
Relative humidity	0 to 75% RH
Operating altitude	0 to 2000m above sea level
Pollution degree	2
Mounting position	Upright
Ventilation	Forced ventilation is not required.
Protection against ingress of solid foreign bodies and water - Front - Rear - Front with seal	IP40 in acc. with EN60529 IP20 in acc. with EN60529 IP42 in acc. with EN60529





Supply voltage	
Installations of overvoltage category	300V CAT III
Protection of the supply voltage (fuse)	6A, type C (approved i.a.w. UL/IEC)
Nominal range	90V - 277V (45 - 65 Hz) or DC 90V - 250V
Operating range	+/-10% of nominal range
Power consumption	max. 7VA / 4W

Voltage measurement	
Three-phase 4-conductor systems with rated voltages up to	277V/480V (+/-10%)
Three-phase 3-conductor systems, unearthed, with rated voltages up to	IT 480V (+/-10%)
Overvoltage category	300V CAT III
Measurement surge voltage	4kV
Measurement range L-N	0 <sup>1)</sup> to 300Vrms (max. overvoltage 520Vrms )
Measurement range L-L	0 <sup>1)</sup> to 520Vrms (max. overvoltage 900Vrms)
Resolution	0.01V
Crest factor	2.45 (related to the measurement range)
Impedance	4M $\Omega$ /phase
Power consumption	approx. 0.1VA
Sampling rate	21.33 kHz (50Hz), 25.6 kHz (60Hz) for each measurement channel
Frequency range of the fundamental oscillation	45Hz to 65Hz
- Resolution	0.01Hz

<sup>1)</sup> The UMG 96RM-PN can only determine measured values, if a voltage L-N greater than 10Veff or a voltage L-L greater than 18Veff is applied to at least one voltage measurement input.

Current measurement I1 - I4	
Rated current	5A
Measurement range	0 to 6Arms
Crest factor	1,98
Resolution	0.1mA (display 0.01A)
Overvoltage category	300V CAT II
Measurement surge voltage	2kV
Power consumption	Approx. 0.2 VA (Ri=5mOhm)
Overload for 1 sec.	120A (sinusoidal)
Sampling rate	21.33 kHz (50Hz), 25.6 kHz (60Hz) for each measurement channel

Residual current monitoring I5 / I6	
Rated current	30mArms
Limiting current	40mArms
Triggering current	50 $\mu$ A
Resolution	1 $\mu$ A
Crest factor	1.414 (related to 40mA)
Burden	4 Ohm
Overload for 1 sec.	5A
Sustained overload	1A
Overload for 20 ms	50A
Residual current monitoring	i.a.w. IEC/TR 60755 (2008-01), type A  Type B 

<b>Thermistor input</b> 2 optional inputs	
Update time	1 second
Connectable sensors	PT100, PT1000, KTY83, KTY84
Total burden (sensor + cable)	Max. 4 kOhm

Sensor type	Temperature range	Resistor range	Measurement uncertainty
KTY83	-55°C to +175°C	500Ohm to 2.6kOhm	± 1.5% rng
KTY84	-40°C to +300°C	350Ohm to 2.6kOhm	± 1.5% rng
PT100	-99°C to +500°C	60Ohm to 180Ohm	± 1.5% rng
PT1000	-99°C to +500°C	600Ohm to 1.8kOhm	± 1.5% rng

<b>Serial interface</b>	
RS485 to Modbus RTU/Slave	9.6kbps, 19.2kbps, 38.4kbps, 57.6 kbps, 115.2kbps
Stripping length	7mm

<b>Ethernet / ProfiNet interface</b>	
Connection	RJ45
Functions	Embedded webserver (HTTP)
Protocols	TCP/IP, Modbus/TCP (Port 502), ICMP (Ping), NTP, Modbus RTU over Ethernet (Port 8000), FTP, SNMP, DCP, ProfiNet
Conformance Class (CC)	B — Switch class C (IRT)
ProfiNet version	2.2
ProfiNet profiles	PROFIenergy V1.1, Entity Class 2

<b>Digital outputs</b>	
2 and 3 optional additional digital outputs, semiconductor relay, not short-circuit proof	
Switching voltage	Max. 33V AC, 60V DC
Switching current	max. 50mAeff AC/DC
Response time	10/12 periods + 10ms *
Pulse output (energy pulses)	Max. 50Hz

\* Response time, e.g. at 50 Hz: 200ms + 10ms = 210 ms

<b>Digital inputs</b>	
3 optional additional digital outputs, semiconductor relay, not short-circuit proof	
Maximum counter frequency	20Hz
Input signal present	18V to 28V DC (typical 4mA)
Input signal not present	0 to 5V DC, current less than 0.5A

<b>Terminal connection capacity (supply voltage)</b>	
Connectable conductors. Only one conductor can be connected per terminal!	
Single core, multi-core, fine-stranded	0.2 - 2.5mm <sup>2</sup> , AWG 26 - 12
Terminal pins, core end sheath	0.2 - 2.5mm <sup>2</sup>
Tightening torque	0.4 - 0.5Nm
Stripping length	7mm

**Terminal connection capacity (voltage and current measurement)**

Connectable conductors. Only one conductor can be connected per terminal!

	<b>Current</b>	<b>Voltage</b>
Single core, multi-core, fine-stranded	0.2 - 2.5mm <sup>2</sup> , AWG 26-12	0.08 - 4.0mm <sup>2</sup> , AWG 28-12
Terminal pins, core end sheath	0.2 - 2.5mm <sup>2</sup>	0.2 - 2.5mm <sup>2</sup>
Tightening torque	0.4 - 0.5Nm	0.4 - 0.5Nm
Stripping length	7mm	7mm

**Terminal connection capacity (residual current and temperature measurement inputs and digital inputs/outputs)**

Rigid/flexible	0.14 - 1.5mm <sup>2</sup> , AWG 28-16
Flexible with core end sheath without plastic sleeve	0.20 - 1.5mm <sup>2</sup>
Flexible with core end sheath with plastic sleeve	0.20 - 1.5mm <sup>2</sup>
Tightening torque	0.20 - 0.25Nm
Stripping length	7mm

**Cable length (digital inputs / outputs, temperature measurement input)**

Up to 30m	Not screened
Longer than 30m	Screened

**Terminal connection capacity (serial interface)**

Single core, multi-core, fine-stranded	0.20 - 1.5mm <sup>2</sup>
Terminal pins, core end sheath	0.20 - 1.5mm <sup>2</sup>
Tightening torque	0.20 - 0.25Nm
Stripping length	7mm

## Function parameters

Function	Symbol	Precision class	Measurement range	Display range
Total effective power	P	0.5 <sup>5)</sup> (IEC61557-12)	0 to 5.4 kW	0 W to 999 GW *
Total reactive power	QA, Qv	1 (IEC61557-12)	0 to 5.4 kvar	0 varh to 999 Gvar *
Total apparent power	SA, Sv	0.5 <sup>5)</sup> (IEC61557-12)	0 to 5.4 kVA	0 VA to 999 GVA *
Total effective energy	Ea	0.5S <sup>5)</sup> 6) (IEC61557-12)	0 to 5.4 kWh	0 Wh to 999 GWh *
Total reactive energy	ErA, ErV	1 (IEC61557-12)	0 to 5.4 kvarh	0 varh to 999 Gvarh *
Total apparent energy	EapA, EapV	0.5 <sup>5)</sup> (IEC61557-12)	0 to 5.4 kVAh	0 VAh to 999 GVAh *
Frequency	f	0.05 (IEC61557-12)	45 to 65 Hz	45.00 Hz to 65.00 Hz
Phase current I1 - I3	I	0.2 (IEC61557-12)	0 to 6 Arms	0 A to 999 kA
Measured neutral conductor current I4	IN	1 (IEC61557-12)	0 to 6 Arms	0 A to 999 kA
Residual currents I5, I6	IDiff	1 (IEC61557-12)	0 to 40 mA rms	0 A to 999 kA
Computed neutral conductor current	INc	1.0 (IEC61557-12)	0.03 to 25 A	0.03 A to 999 kA
Voltage	U L-N	0.2 (IEC61557-12)	10 to 300 V rms	0 V to 999 kV
Voltage	U L-L	0.2 (IEC61557-12)	18 to 520 V rms	0 V to 999 kV
Power factor	PFA, PFV	0.5 (IEC61557-12)	0.00 to 1.00	0.00 to 1.00
Short-term flicker, long-term flicker	Pst, Plt	-	-	-
Voltage dips (L-N)	Udip	-	-	-
Voltage rises (L-N)	Uswl	-	-	-
Transient overvoltages	Utr	-	-	-
Voltage interruptions	Uint	-	-	-
Voltage unbalance (L-N) <sup>1)</sup>	Unba	-	-	-
Voltage unbalance (L-N) <sup>2)</sup>	Unb	-	-	-
Voltage harmonics	Uh	Cl. 1 (IEC61000-4-7)	Up to 2.5 kHz	0 V to 999 kV
THD of the voltage <sup>3)</sup>	THDu	1.0 (IEC61557-12)	Up to 2.5 kHz	0% to 999%
THD of the voltage <sup>4)</sup>	THD-Ru	-	-	-

Function	Symbol	Precision class	Measurement range	Display range
Current harmonics	lh	Cl. 1 (IEC61000-4-7)	Up to 2.5 kHz	0 A to 999 kA
THD of the current <sup>3)</sup>	THDi	1.0 (IEC61557-12)	Up to 2.5 kHz	0% to 999%
THD of the current <sup>4)</sup>	THD-Ri	-	-	-
Mains signal voltage	MSV	-	-	-

1) In relation to the amplitude.

2) In relation to phase and amplitude.

3) In relation to fundamental oscillation.

4) In relation to effective value.

5) Precision class 0.5 with.../ 5A converter.

Precision class 1 with.../ 1A converter.

6) Precision class 0.5S per IEC62053-22

\* When the max. total working value range has been reached, the display returns to 0.

## Parameters and Modbus address list

The excerpt of the following parameter list contains settings necessary for proper operation of the UMG 96RM-PN, e.g. current transformers and device address. The values in the parameter list can be described and read.



A complete overview of the parameters and measured values as well as explanations on selected measured values can be found in the document "Modbus Address List", which can be found on the CD or online.

The excerpt of the measured value list stores the measured and calculated measured values, status data for the outputs, and logged values for viewing.



The addresses listed in this documentation within the range 0-800 can be set directly on the device. The addresses in the range of 1000 and above can only be edited via Modbus!

**Table 1 - Parameter list**

Address	Format	RD/WR	Unit	Comment	Setting range	Default
0	SHORT	RD/WR	-	Device address	0 - 255 <sup>(1)</sup>	1
1	SHORT	RD/WR	kbps	Baud rate (0=9.6kbps, 1=19.2kbps, 2=38.4kbps, 3= 57.6kbps, 4=115.2kbps)	0 - 7 (5 - 7 for internal use only)	4
3	SHORT	RD/WR	-	Stop bits (0=1 bit, 1=2 bits)	0, 1	0
10	FLOAT	RD/WR	A	Current transformer I1, primary	0 - 1,000,000 <sup>(2)</sup>	5
12	FLOAT	RD/WR	A	Current transformer I1, sec.	1 - 5	5
14	FLOAT	RD/WR	V	Voltage transformer V1, prim.	0 - 1,000,000 <sup>(2)</sup>	400
16	FLOAT	RD/WR	V	Voltage transformer V1, sec.	100, 400	400
18	FLOAT	RD/WR	A	Current transformer I2, primary	0 - 1,000,000 <sup>(2)</sup>	5
20	FLOAT	RD/WR	A	Current transformer I2, sec.	1 - 5	5

<sup>(1)</sup> The values 0 and 248 to 255 are reserved and must not be used.

<sup>(2)</sup> The adjustable value 0 does not produce any meaningful work values, and must not be used.



Address	Format	RD/WR	Unit	Comment	Setting range	Default
22	FLOAT	RD/WR	V	Voltage transformer V2, prim.	0 - 1,000,000	400
24	FLOAT	RD/WR	V	Voltage transformer V2, sec.	100, 400	400
26	FLOAT	RD/WR	A	Current transformer I3, primary	0 - 1,000,000	5
28	FLOAT	RD/WR	A	Current transformer I3, sec.	1 - 5	5
30	FLOAT	RD/WR	V	Voltage transformer V3, prim.	0 - 1,000,000	400
32	FLOAT	RD/WR	V	Voltage transformer V3, sec.	100, 400	400
34	SHORT	RD/WR	Hz	Frequency estimation 0=Auto, 45 - 65=Hz	0, 45 - 65	0
35	SHORT	RD/WR	-	Screen contrast 0 (low), 9 (high)	0 - 9	5
36	SHORT	RD/WR	-	Backlight 0 (dark), 9 (bright)	0 - 9	6
37	SHORT	RD/WR	-	Screen profile 0=Preassigned screen profile 1=Preassigned screen profile 2=Preassigned screen profile 3=Freely selectable screen profile	0 - 3	0
38	SHORT	RD/WR	-	Screen rotation profile 0..2=Preassigned screen rotation profiles 3=Freely selectable screen rotation profile	0 - 3	0
39	SHORT	RD/WR	s	Rotation time	0 - 60	0
40	SHORT	RD/WR	-	Averaging time, I	0 - 8*	6
41	SHORT	RD/WR	-	Averaging time, P	0 - 8*	6
42	SHORT	RD/WR	-	Averaging time, U	0 - 8*	6
45	USHORT	RD/WR	mA	Current measurement response threshold I1 - I3	0 - 200	5
50	SHORT	RD/WR	-	Password	0 - 999	0 (no password)

\* 0 = 5secs; 1 = 10secs; 2 = 15secs; 3 = 30secs; 4 = 1min.; 5 = 5mins; 6 = 8mins; 7 = 10mins; 8 = 15mins

Address	Format	RD/WR	Unit	Comment	Setting range	Default
100	SHORT	RD/WR	-	Address of the measured value, digital outp. 1	0 - 32,000	874
101	SHORT	RD/WR	-	Address of the measured value, Digital outp. 2	0 - 32,000	882
102	FLOAT	RD/WR	Wh	Pulse value, Digital output 1	-1,000,000 to +1,000,000	1000
104	FLOAT	RD/WR	Wh	Pulse value, Digital output 2	-1,000,000 to +1,000,000	1000
106	SHORT	RD/WR	10ms	Minimum pulse length (1=10ms) Digital outp. 1/2	1 - 1000	5 (=50ms)
107	SHORT	RD/WR	-	Result of Comparator group 1; Combine A, B, C (1=and, 0=or)	0,1	0
108	FLOAT	RD/WR	-	Comparator 1A, Threshold value	$-10^{12}-1$ to $+10^{12}-1$	0
110	SHORT	RD/WR	-	Comparator 1A, address of the measured value	0 - 32,000	0
111	SHORT	RD/WR	s	Comparator 1A, min. switch-on time	0 - 32,000	0
112	SHORT	RD/WR	s	Comparator 1A, lead time	0 - 32,000	0
113	SHORT	RD/WR	-	Comparator 1A, Operator ">="=0, "< "=1	0,1	0
114	FLOAT	RD/WR	-	Comparator 1B, Threshold value	$-10^{12}-1$ to $+10^{12}-1$	0
116	SHORT	RD/WR	-	Comparator 1B, address of the measured value	0 - 32,000	0
117	SHORT	RD/WR	s	Comparator 1B, min. switch-on time	0 - 32,000	0
118	SHORT	RD/WR	s	Comparator 1B, lead time	0 - 32,000	0
119	SHORT	RD/WR	-	Comparator 1B, Operator ">="=0, "< "=1	0,1	0
120	FLOAT	RD/WR	-	Comparator 1C, Threshold value	$-10^{12}-1$ to $+10^{12}-1$	0
122	SHORT	RD/WR	-	Comparator 1C, address of the measured value	0 - 32,000	0

Address	Format	RD/WR	Unit	Comment	Setting range	Default
123	SHORT	RD/WR	s	Comparator 1C, min. switch-on time	0 - 32,000	0
124	SHORT	RD/WR	s	Comparator 1C, lead time	0 - 32,000	0
125	SHORT	RD/WR	-	Comparator 1C, Operator ">="=0, "<"=1	0,1	0
126	SHORT	RD/WR	-	Result of Comparator group 2; Combine A, B, C (1=and, 0=or)	0,1	0
127	FLOAT	RD/WR	-	Comparator 2A, Threshold value	$-10^{12}-1$ to $+10^{12}-1$	0
129	SHORT	RD/WR	-	Comparator 2A, address of the measured value	0 - 32,000	0
130	SHORT	RD/WR	s	Comparator 2A, min. switch-on time	0 - 32,000	0
131	SHORT	RD/WR	s	Comparator 2A, lead time	0 - 32,000	0
132	SHORT	RD/WR	-	Comparator 2A, Operator ">="=0, "<"=1	0,1	0
133	FLOAT	RD/WR	-	Comparator 2B, Threshold value	$-10^{12}-1$ to $+10^{12}-1$	0
135	SHORT	RD/WR	-	Comparator 2B, address of the measured value	0 - 32,000	0
136	SHORT	RD/WR	s	Comparator 2B, min. switch-on time	0 - 32,000	0
137	SHORT	RD/WR	s	Comparator 2B, lead time	0 - 32,000	0
138	SHORT	RD/WR	-	Comparator 2B, Operator ">="=0, "<"=1	0,1	0
139	FLOAT	RD/WR	-	Comparator 2C, Threshold value	$-10^{12}-1$ to $+10^{12}-1$	0
141	SHORT	RD/WR	-	Comparator 2C, address of the measured value	0 - 32,000	0
142	SHORT	RD/WR	s	Comparator 2C, min. switch-on time	0 - 32,000	0
143	SHORT	RD/WR	s	Comparator 2C, lead time	0 - 32,000	0
144	SHORT	RD/WR	-	Comparator 2C, Operator ">="=0, "<"=1	0,1	0

Address	Format	RD/WR	Unit	Comment	Setting range	Default
145	SHORT	RD/WR	-	"Flash display" Bit 1 = 1/0: active/inactive for Comparator group output 1 Bit 2 = 1/0: active/inactive for Comparator group output 2	0-3	0
200	SHORT	RD/WR	-	Selection of source for Digital output 1	0 - 5 <sup>*1</sup>	1
201	SHORT	RD/WR	-	Inverter Digital output 1	0, 1 <sup>*2</sup>	0
202	SHORT	RD/WR	-	Selection of source for Digital output 2	0 - 5 <sup>*1</sup>	1
203	SHORT	RD/WR	-	Inverter Digital output 2	0, 1 <sup>*2</sup>	0
500	SHORT	RD/WR	-	Terminal assignment, I L1	-3 to 0 to +3 <sup>*3</sup>	+1
501	SHORT	RD/WR	-	Terminal assignment, I L2	-3 to 0 to +3 <sup>*3</sup>	+2
502	SHORT	RD/WR	-	Terminal assignment, I L3	-3 to 0 to +3 <sup>*3</sup>	+3
503	SHORT	RD/WR	-	Terminal assignment, U L1	0 - 3 <sup>*3</sup>	1
504	SHORT	RD/WR	-	Terminal assignment, U L2	0 - 3 <sup>*3</sup>	2
505	SHORT	RD/WR	-	Terminal assignment, U L3	0 - 3 <sup>*3</sup>	3
506	SHORT	RD/WR	-	Clear min and max values	0 - 1	0
507	SHORT	RD/WR	-	Clear energy counter	0 - 1	0
508	SHORT	RD/WR	-	Force write to EEPROM	0 - 1	0
Note: Energy values and min/max values are written to the EEPROM every 5 minutes.						
509	SHORT	RD/WR	-	Connection diagram, voltage	0 - 8 <sup>*4</sup>	0
510	SHORT	RD/WR	-	Connection diagram, current	0 - 8	0
511	SHORT	RD/WR	-	Relevant voltage for THD and FFT	0, 1	0
In the display, the voltages can be displayed for THD and FFT as L-N or as L-L values. 0=L-N, 1=L-L						

Address	Format	RD/WR	Unit	Comment	Setting range	Default
521	SHORT	RD/WR	-	Switch I/Os of Group 2 0=Output, 1=Input	0,1	0
524	SHORT	RD/WR	-	Inverter Digital output 3	0, 1 <sup>*2</sup>	0
525	SHORT	RD/WR	-	Inverter Digital output 4	0, 1 <sup>*2</sup>	0
524	SHORT	RD/WR	-	Inverter Digital output 5	0, 1 <sup>*2</sup>	0
530	FLOAT	RD/WR	A	Current transformer I4, primary	0 - 1,000,000 <sup>(*)2</sup>	5
532	FLOAT	RD/WR	A	Current transformer I4, sec.	1.0 - 5.0	5
534	FLOAT	RD/WR	A	Current transformer I5, primary	0.0 - 1,000,000.0 <sup>(*)2</sup>	1
536	FLOAT	RD/WR	A	Current transformer I5, sec.	1.0 - 5.0	1
538	FLOAT	RD/WR	A	Current transformer I6, primary	0.0 - 1,000,000.0 <sup>(*)2</sup>	1
540	FLOAT	RD/WR	A	Current transformer I6, sec.	1.0 - 5.0	1
542	SHORT	RD/WR	-	Input type I5 0=Residual current, 1=Temperature	0,1	0
543	SHORT	RD/WR	-	Input type I6 0=Residual current, 1=Temperature	0,1	0
544	FLOAT	RD/WR	-	Temperature offset temp 1	-1000.0 to 1000.0	0
546	FLOAT	RD/WR	-	Temperature offset temp 2	-1000.0 to 1000.0	0
548	SHORT	RD/WR	-	Temperature sensor temp 1 (0=PT100, 1=PT1000, 2=KTY83, 3=KTY84, 4=Resistance in ohms)	0 - 4	0
549	SHORT	RD/WR	-	Temperature sensor temp 2 (0=PT100, 1=PT1000, 2=KTY83, 3=KTY84, 4=Resistance in ohms)	0 - 4	0
550	SHORT	RD/WR	-	Tariff configuration, Input 1 If Input 1 is active, counters are set in Tariff 1*	0 - 127	0
551	SHORT	RD/WR	-	Tariff configuration, Input 2 If Input 2 is active, counters are set in Tariff 2*	0 - 127	0
552	SHORT	RD/WR	-	Tariff configuration, Input 3 If Input 3 is active, counters are set in Tariff 3*	0 - 127	0

Address	Format	RD/WR	Unit	Comment	Setting range	Default
553	SHORT	RD/WR	-	Transformer monitoring I5	0 (inactive), 1 (active)	0
554	SHORT	RD/WR	-	Transformer monitoring I6	0 (inactive), 1 (active)	0
600	UINT	RD/WR	-	Measurement range exceeded	0 to 0xFFFFFFFF	
602	SHORT	RD/WR	-	Modbus value for Output 1	0, 1	
605	SHORT	RD/WR	-	Modbus value for Output 2	0, 1	
608	SHORT	RD	-	Status, Output 1		
609	SHORT	RD	-	Status, Output 2		
610	SHORT	RD	-	Comparator result 1, Output A		
611	SHORT	RD	-	Comparator result 1, Output B		
612	SHORT	RD	-	Comparator result 1, Output C		
613	SHORT	RD	-	Comparator result 2, Output A		
614	SHORT	RD	-	Comparator result 2, Output B		
615	SHORT	RD	-	Comparator result 2, Output C		
616	SHORT	RD	-	Combination result, Comparator group 1		
617	SHORT	RD	-	Combination result, Comparator group 2		
746	SHORT	RD/WR	s	After how long to switch to standby lighting	60 to 9999	900
747	SHORT	RD/WR	s	Brightness of standby lighting	0 - 9	0
750	SHORT	RD	-	Software release		
754	SERNR	RD	-	Serial number		
756	SERNR	RD	-	Production number		



The display only depicts the first 3 digits (###) of a value. Values higher than 1000 are indicated by "k". Example: 003k = 3000

\* The tariff counter is activated by a bit-by-bit coding:

Bit 0 = Effective energy, Bit 1 = Effective energy (consumed), Bit 2 = Effective energy (delivered)  
 Bit 3 = Reactive energy, Bit 4 = Reactive energy (inductive), Bit 5 = Reactive energy (capacitive)  
 Bit 6 = Apparent energy

**Table 2 - Modbus address list**

(often needed measured values)



The addresses listed in this documentation within the range 0-800 can be set directly on the device.

The address range 800-999 is available for the programming of comparators on the device. The addresses in the range of 1000 and above can only be edited via Modbus!



A complete overview of the parameters and measured values as well as explanations on selected measured values can be found in the document "Modbus Address List", which can be found on the CD or online.

Modbus Address	Address on display	Format	RD/WR	Unit	Comment
19000	808	float	RD	V	Voltage L1-N
19002	810	float	RD	V	Voltage L2-N
19004	812	float	RD	V	Voltage L3-N
19006	814	float	RD	V	Voltage L1-L2
19008	816	float	RD	V	Voltage L2-L3
19010	818	float	RD	V	Voltage L3-L1
19012	860	float	RD	A	Current, L1
19014	862	float	RD	A	Current, L2
19016	864	float	RD	A	Current, L3
19018	866	float	RD	A	Vector sum; $IN=I1+I2+I3$
19020	868	float	RD	W	Effective power L1
19022	870	float	RD	W	Effective power L2
19024	872	float	RD	W	Effective power L3
19026	874	float	RD	W	Sum; $Psum3=P1+P2+P3$
19028	884	float	RD	VA	Apparent power S L1
19030	886	float	RD	VA	Apparent power S L2

Modbus Address	Address on display	Format	RD/WR	Unit	Comment
19032	888	float	RD	VA	Apparent power S L3
19034	890	float	RD	VA	Sum; Ssum3=S1+S2+S3
19036	876	float	RD	var	Fund. reactive power (mains frequ.) Q L1
19038	878	float	RD	var	Fund. reactive power (mains frequ.) Q L2
19040	880	float	RD	var	Fund. reactive power (mains frequ.) Q L3
19042	882	float	RD	var	Sum; Qsum3=Q1+Q2+Q3
19044	820	float	RD	-	Fund.power factor, CosPhi; U L1-N IL1
19046	822	float	RD	-	Fund.power factor, CosPhi; U L2-N IL2
19048	824	float	RD	-	Fund.power factor, CosPhi; U L3-N IL3
19050	800	float	RD	Hz	Measured frequency
19052	-	float	RD	-	Rotation field; 1=right, 0=none, -1=left
19054	-	float	RD	Wh	Effective energy L1
19056	-	float	RD	Wh	Effective energy L2
19058	-	float	RD	Wh	Effective energy L3
19060	-	float	RD	Wh	Effective energy L1 - L3
19062	-	float	RD	Wh	Effective energy L1, consumed
19064	-	float	RD	Wh	Effective energy L2, consumed
19066	-	float	RD	Wh	Effective energy L3, consumed
19068	-	float	RD	Wh	Effective energy L1..L3, consumed, rate 1
19070	-	float	RD	Wh	Effective energy L1, delivered
19072	-	float	RD	Wh	Effective energy L2, delivered
19074	-	float	RD	Wh	Effective energy L3, delivered
19076	-	float	RD	Wh	Effective energy L1 - L3, delivered
19078	-	float	RD	VAh	Apparent energy L1
19080	-	float	RD	VAh	Apparent energy L2
19082	-	float	RD	VAh	Apparent energy L3
19084	-	float	RD	VAh	Apparent energy L1 - L3
19086	-	float	RD	varh	Reactive energy L1
19088	-	float	RD	varh	Reactive energy L2
19090	-	float	RD	varh	Reactive energy L3
19092	-	float	RD	varh	Reactive energy L1 - L3



Modbus Address	Address on display	Format	RD/WR	Unit	Comment
19094	-	float	RD	varh	Reactive energy, inductive, L1
19096	-	float	RD	varh	Reactive energy, inductive, L2
19098	-	float	RD	varh	Reactive energy, inductive, L3
19100	-	float	RD	varh	Reactive energy L1 - L3, ind.
19102	-	float	RD	varh	Reactive energy, capacitive, L1
19104	-	float	RD	varh	Reactive energy, capacitive, L2
19106	-	float	RD	varh	Reactive energy, capacitive, L3
19108	-	float	RD	varh	Reactive energy L1 - L3, cap.
19110	836	float	RD	%	Harmonic, THD, U L1-N
19112	838	float	RD	%	Harmonic, THD, U L2-N
19114	840	float	RD	%	Harmonic, THD, U L3-N
19116	908	float	RD	%	Harmonic, THD, I L1
19118	910	float	RD	%	Harmonic, THD, I L2
19120	912	float	RD	%	Harmonic, THD, I L3

## Number formats

Type	Size	Minimum	Maximum
short	16 bit	$-2^{15}$	$2^{15} - 1$
ushort	16 bit	0	$2^{16} - 1$
int	32 bit	$-2^{31}$	$2^{31} - 1$
uint	32 bit	0	$2^{32} - 1$
float	32 bit	IEEE 754	IEEE 754



### Information on saving measured values and configuration data:

- The following measured values are saved at least every 5 minutes:
  - Comparator timer
  - S0 counter statuses
  - Min. / Max. / Mean values
  - Energy values
- Configuration data is saved immediately!



## Dimension diagrams

All dimensions in mm

### Rear view

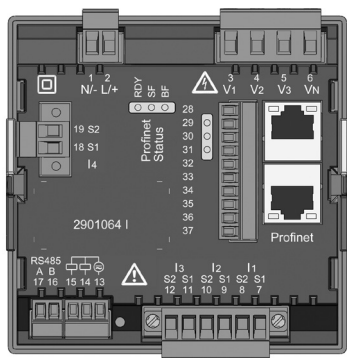

### View from below

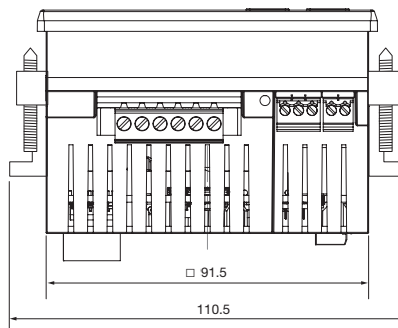

Side view

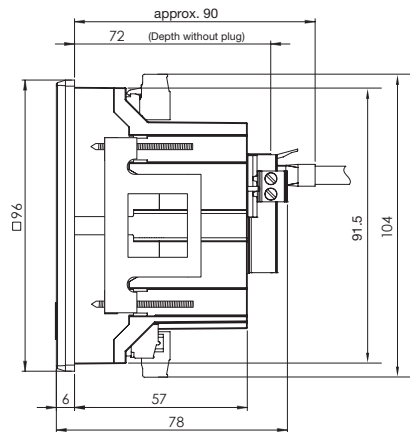

Cut-out size

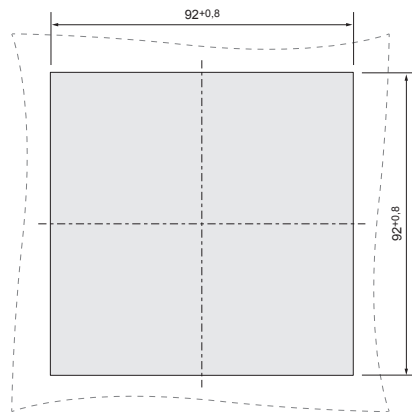

## Measured value screen overview

▲ A01 Measured values L1-N voltage L2-N voltage L3-N voltage	▶ B01 Mean values L1-N voltage L2-N voltage L3-N voltage	▶ C01 Max values L1-N voltage L2-N voltage L3-N voltage	▶ D01 Min values L1-N voltage L2-N voltage L3-N voltage
▲ A02 Measured values L1-L2 voltage L2-L3 voltage L3-L1 voltage	B02 Mean values L1-L2 voltage L2-L3 voltage L3-L1 voltage	C02 Max values L1-L2 voltage L2-L3 voltage L3-L1 voltage	D02 Min values L1-L2 voltage L2-L3 voltage L3-L1 voltage
▲ A03 Measured values L1 current L2 current L3 current	B03 Mean values L1 current L2 current L3 current	C03 Max values L1 current L2 current L3 current	D03 Max values (mean v.) L1 current L2 current L3 current
▲ A04 Measured value Sum Current on the N	B04 Mean value Sum Current on the N	C04 Max value Total measured value Current on the N	D04 Max values Total mean value Current on the N
▲ A05 Measured values L1 effective power L2 effective power L3 effective power	B05 Mean value L1 effective power L2 effective power L3 effective power	C05 Max values L1 effective power L2 effective power L3 effective power	
▲ A06 Measured value Total effective power	B06 Mean value Total effective power	C06 Max value Total effective power	D06 Max value Total eff.pow. mean value
▲ A07 Measured values L1 apparent power L2 apparent power L3 apparent power	B07 Mean values L1 apparent power L2 apparent power L3 apparent power	C07 Max values L1 apparent power L2 apparent power L3 apparent power	

△	A08	▷	B08	▷	C08	▷
	Measured value Sum Apparent power		Mean value Sum Apparent power		Max value Sum Apparent power	
△	A09		B09		C09	
	Measured values L1 reactive power L2 reactive power L3 reactive power		Mean values L1 reactive power L2 reactive power L3 reactive power		Max values (ind) L1 reactive power L2 reactive power L3 reactive power	
△	A10		B10		C10	
	Measured value Total reactive p.		Mean value Total reactive p.		Max value (ind) Total reactive p.	
△	A11		B11		C11	
	Measured value Harmonic distortion (THD) U L1		Measured value Harmonic distortion (THD) U L2		Measured value Harmonic distortion (THD) U L3	
△	A12		B12		C12	
	Measured value Harmonic distortion (THD) I L1		Measured value Harmonic distortion (THD) I L2		Measured value Harmonic distortion (THD) I L3	
△	A13		B13		C13	
	Max value Harmonic distortion (THD) U L1		Max value Harmonic distortion (THD) U L2		Max value Harmonic distortion (THD) U L3	
△	A14		B14		C14	
	Max value Harmonic distortion (THD) I L1		Max value Harmonic distortion (THD) I L2		Max value Harmonic distortion (THD) I L3	

A15 Measured value L1 cos(phi) L2 cos(phi) L3 cos(phi)						
A16 Measured value Sum of cos(phi)	B16 Mean value Sum of cos(phi)					
A17 Measured value Frequency L1 Rotary field indication						
A18 Measured value Total effective energy (without backstop)	B18 Measured value Total effective energy (consumption)	C18 Measured value Total effective energy (delivery)	D18 Measured value Total Apparent energy	E18 Measured value Effective energy L1 Consumption (Tariff 1)	F18 Measured value Effective energy L2 Consumption (Tariff 1)	G18 Measured value Effective energy L3 Consumption (Tariff 1)
A19 Measured value (ind) Reactive energy	B19 Measured value Total Reactive energy cap.	C19 Measured value Total Reactive energy cap.	D19 Measured value Reactive energy L1 ind. (Tariff 1)	E19 Measured value Reactive energy L2 ind. (Tariff 1)	F19 Measured value Reactive energy L3 ind. (Tariff 1)	
A20 Operating hours counter 1	B20 Comparator 1A* Total running time	...	G20 Comparator 2C* Total running time			
A21 Measured value 1st harmonics U L1	B21 Measured value 3rd harmonics U L1	...	H21 Measured value 15th harmonics U L1			

The highlighted menus are not displayed with the factory default setting.

\* Only the first 6 comparators are displayed.



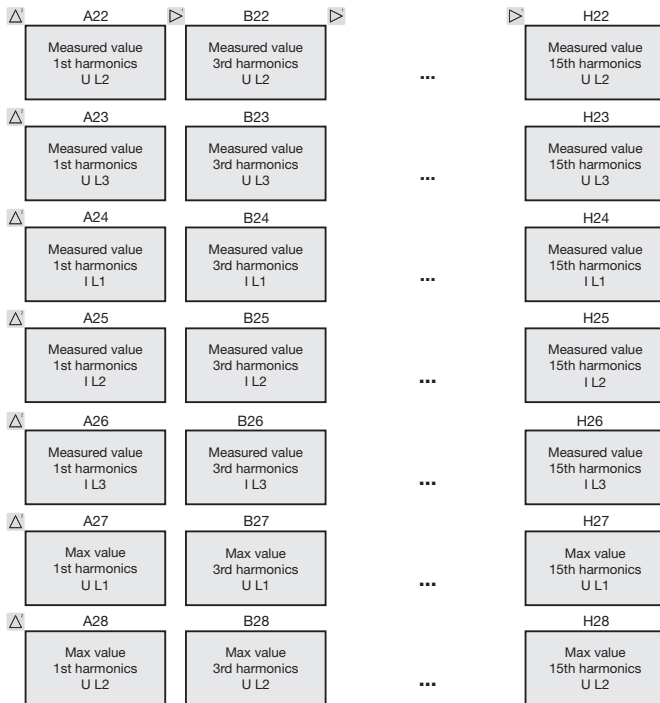

The highlighted menus are not displayed with the factory default setting.

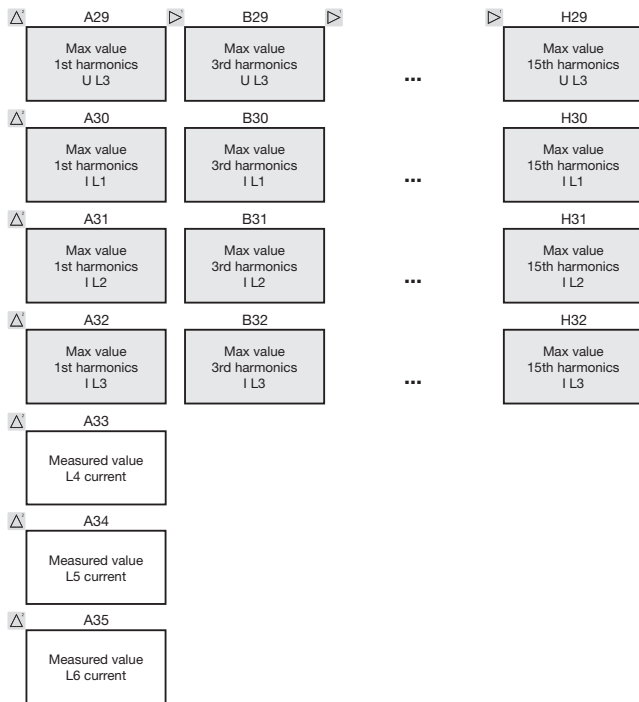

The highlighted menus are not displayed with the factory default setting.

**Even and odd harmonics up to the 40th order** can be accessed and displayed in the GridVis software.



## Declaration of conformity

The product fulfils the following EC Directives:	
2004/108/EC	Electromagnetic compatibility of equipment.
2006/95/EC	Electrical equipment for use within certain voltage limits.
Standards taken into consideration:	
Immunity from interference IEC/EN 61326-1:2013 IEC/EN 61000-4-2:2009 IEC/EN 61000-4-3:2011 IEC/EN 61000-4-4:2013 IEC/EN 61000-4-5:2007 IEC/EN 61000-4-6:2009 IEC/EN 61000-4-8:2010 IEC/EN 61000-4-11:2005	Class A: Industrial area Electrostatic discharge immunity Electromagnetic fields 80-2700MHz Fast transients Surge voltages Immunity to conducted disturbances, induced by radio-frequency fields 0.15-80MHz Power frequency magnetic fields Voltage drops, short term interruptions, voltage variations and frequency change
Emissions IEC/EN 61326-1:2013 IEC/CISPR11/EN 55011:2011 IEC/CISPR11/EN 55011:2011	Class A: Industrial area RFI field strength 30-1000MHz Radiated interference voltage 0.15-30MHz
Equipment safety IEC/EN 61010-1:2011  IEC/EN 61010-2-030:2011	Safety requirements for electrical equipment for measurement, control, and laboratory use - part 1: General requirements Particular requirements for testing and measuring circuits

## Connection example 1

(with residual current monitoring IPE / IDIFF)

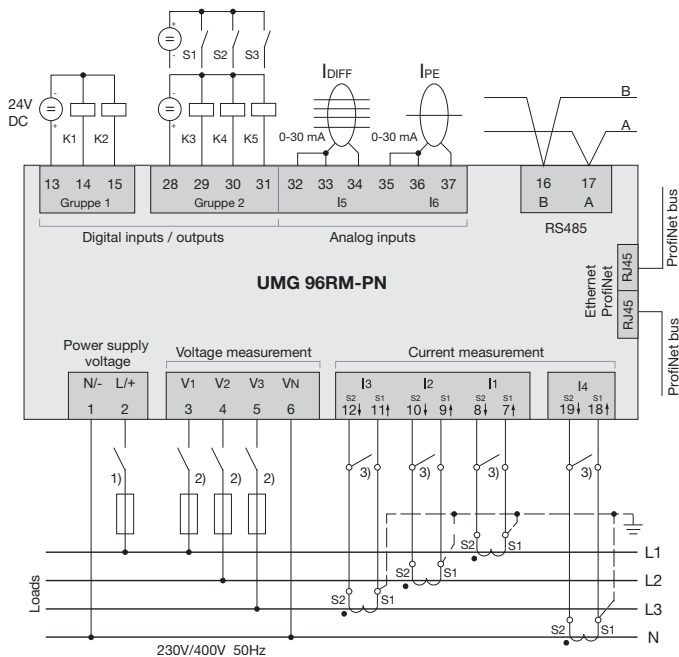

- 1) UL/IEC-approved fuse (6A, type C)
- 2) UL/IEC-approved fuse (10A, type C)
- 3) Short circuit jumpers (external)

## Connection example 2

(with temperature and residual current monitoring)

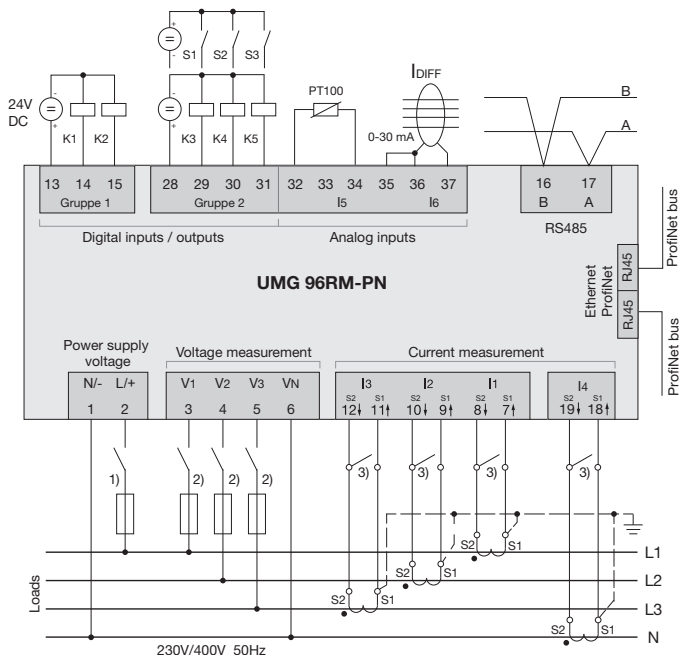

- 1) UL/IEC-approved fuse (6A, type C)
- 2) UL/IEC-approved fuse (10A, type C)
- 3) Short circuit jumpers (external)

## Basic functions quick guide

### Modify current transformer setting

Switch to Programming mode:

- Switching to Programming mode is done by pressing buttons 1 and 2 simultaneously for approx. 1 second. The symbols for Programming mode "PRG", and for the current transformer "CT" appear.
- The selection is confirmed with button 1.
- The first digit of the input range for the primary current flashes.

Modify primary current

- Modify the flashing digit with button 2.
- Use button 1 to select the next number you wish to modify. The selected digit to be modified flashes. If the entire number flashes, the decimal point can be moved with button 2.

Modify secondary current

- Only 1A or 5A can be set as the secondary current.
- Use button 1 to select the secondary current.
- Modify the flashing digit with button 2.

Exit Programming mode

- Switching to Display mode is done by pressing buttons 1 and 2 again simultaneously for approx. 1 second.

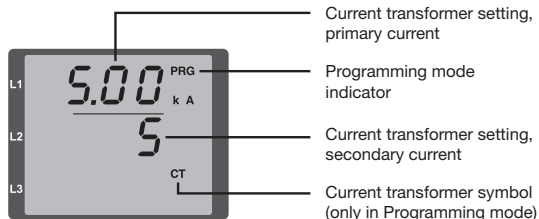

### Retrieving measured values

Switch to Display mode:

- If Programming mode is still active (PRG and CT symbols shown on the display), pressing buttons 1 and 2 simultaneously for approx. 1 second switches to Display mode.
- A measured value screen, e.g. for the voltage, appears

Button control

- Button 2 is used to switch between the measured value screens for current, voltage, power, etc.
- Button 1 is used to switch between the mean values, max values, etc. associated with a particular measured value.



## TCP/IP addressing quick guide

### Manual TCP/IP settings

Switch to Programming mode:

- Switching to Programming mode is done by pressing buttons 1 and 2 simultaneously for approx. 1 second. The symbols for Programming mode "PRG", and for the current transformer "CT" appear.

Set the TCP/IP address (addr.)

- Use button 2 to switch to "Adr" on the display.
- Use button 1 to select the first digit of the address (Byte 0) (digit flashes). Select the digit with button 2.
- Select the next digit with button 1 (digit flashes) and use button 2 to set the desired digit.
- Once Byte 0 of the address is set, bytes 1 to 3 can be set with button 1. Then the display jumps back to Byte 0 (**none** of the digits are flashing).

Subnet mask (SUB)

- Use button 2 to switch to the subnet mask area and set it with buttons 1 and 2, in the same way as the address.

Set gateway address (GAt)

- Use buttons 2 and 1 to set the gateway in the same way as the address.

Exit Programming mode

- Exit the mode by pressing buttons 1 and 2 simultaneously, or wait for 60 seconds.

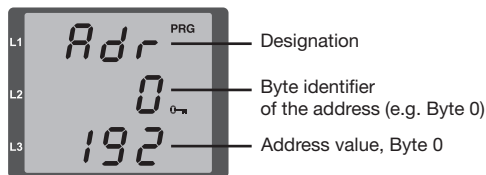

*Fig. TCP/IP address, Byte 1*  
A TCP/IP address consists of 4 bytes with the following structure:

