



Product designation	Pushbutton actuators, spring return, with symbol
Product type designation	LPCB15

General characteristics

Colour	Black
Type of positions	Flush pushbutton
Material	Polyamide
IEC degree of protection	IP66, IP67 and IP69K

Mechanical features

Operating force	kg-lb	<0.5Kg / 1.1lb
Mechanical life	cycles	5000000
Fixing		Without mounting adapter
Mounting adapter		LPXAU120
Weight	g	25

UL technical data

UL degree of protection	Type1, 2, 3R, 4, 4X, 12, 12K
-------------------------	------------------------------

Ambient conditions

Temperature	Operating temperature	min	°C	-25
		max	°C	+70
	Storage temperature	min	°C	-40
		max	°C	+85

Dimensions

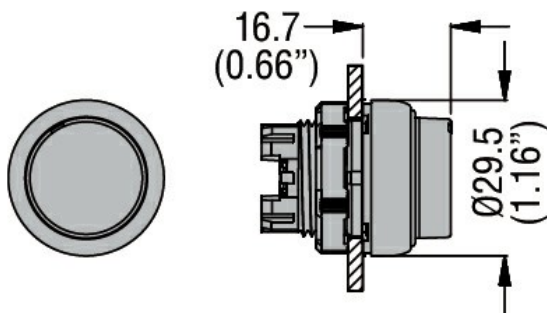

Certifications and compliance

Compliance	CSA C22.2 n° 14
	IEC/EN/BS 60947-1
	IEC/EN/BS 60947-5-1

UL508

Certificates

CCC

cULus

EAC

RINA

ETIM classification

ETIM 8.0

EC000221 -
Front element for
push button