

# M40S-60A503AA0

M4000 Advanced Curtain

**SAFETY LIGHT CURTAINS**

**SICK**  
Sensor Intelligence.

Illustration may differ

### Ordering information

Resolution	Scanning range	Protective field height	System part	Type	Part no.
14 mm	10 m	300 mm	Sender	M40S-60A503AA0	1203262

Other models and accessories → [www.sick.com/M4000\\_Advanced\\_Curtain](http://www.sick.com/M4000_Advanced_Curtain)



### Detailed technical data

#### Features

<b>System part</b>	Sender
<b>Resolution</b>	14 mm
<b>Scanning range</b>	10 m
<b>Protective field height</b>	300 mm
<b>Synchronization</b>	Optical synchronisation

#### Safety-related parameters

<b>Type</b>	Type 4 (IEC 61496-1)
<b>Safety integrity level</b>	SIL 3 (IEC 61508)
<b>Category</b>	Category 4 (EN ISO 13849)
<b>Performance level</b>	PL e (EN ISO 13849)
<b>PFH<sub>D</sub> (mean probability of a dangerous failure per hour)</b>	$28 \times 10^{-9}$ (EN ISO 13849)
<b>T<sub>M</sub> (mission time)</b>	20 years (EN ISO 13849)
<b>Safe state in the event of a fault</b>	At least one OSSD is in the OFF state.

#### Functions

	Functions	Delivery status
<b>Restart interlock</b>	✓	Internal
<b>External device monitoring (EDM)</b>	✓	Activated
<b>Beam coding</b>	✓	Uncoded
<b>Configurable status output (ADO)</b>	✓	Contamination (OWS)
<b>Sender test</b>	✓	Deactivated
<b>Configurable scanning range</b>	✓	Low scanning range
<b>Safe SICK device communication via EFI</b>	✓	
<b>Differentiation between man and material (muting)</b>	✓ <sup>1)</sup>	

<sup>1)</sup> The muting functions can only be used in combination with the UE403 muting switching amplifier or a suitable safety controller (e.g., Flexi Classic, Flexi Soft).

## Interfaces

<b>System connection</b>	
Connection type	Hirschmann male connector M26, 12-pin
Permitted cable length	≤ 50 m <sup>1)</sup>
Permitted cross-section	≥ 0 mm <sup>2</sup>
<b>Configuration method</b>	Via software
<b>Configuration connection</b>	Female connector M8, 4-pin
<b>Display elements</b>	7-segment display, LEDs
<b>Status display</b>	LEDs

<sup>1)</sup> Depending on load, power supply and wire cross-section. The technical specifications must be observed.

## Electrical data

<b>Protection class</b>	III (IEC 61140)
<b>Supply voltage <math>V_S</math></b>	24 V DC (19.2 V ... 28.8 V)
<b>Residual ripple</b>	≤ 10 % <sup>1)</sup>
<b>Power consumption</b>	≤ 0.3 A

<sup>1)</sup> Within the limits of  $V_S$ .

## Mechanical data

<b>Housing cross-section</b>	52 mm x 55.5 mm
<b>Housing material</b>	Aluminum alloy ALMGSI 0.5
<b>Surface treatment</b>	Powder coated
<b>Front screen material</b>	Polycarbonate, scratch-resistant coating

## Ambient data

<b>Enclosure rating</b>	IP65 (EN 60529)
<b>Ambient operating temperature</b>	-30 °C ... +55 °C
<b>Storage temperature</b>	-30 °C ... +70 °C
<b>Air humidity</b>	15 % ... 95 %, Non-condensing
<b>Vibration resistance</b>	5 g, 10 Hz ... 55 Hz (IEC 60068-2-6)
<b>Shock resistance</b>	10 g, 16 ms (EN 60068-2-29)

## Other information

<b>Wave length</b>	850 nm
--------------------	--------

## Classifications

<b>ECLASS 5.0</b>	27272704
<b>ECLASS 5.1.4</b>	27272704
<b>ECLASS 6.0</b>	27272704
<b>ECLASS 6.2</b>	27272704
<b>ECLASS 7.0</b>	27272704
<b>ECLASS 8.0</b>	27272704
<b>ECLASS 8.1</b>	27272704
<b>ECLASS 9.0</b>	27272704
<b>ECLASS 10.0</b>	27272704

# M40S-60A503AA0 | M4000 Advanced Curtain

## SAFETY LIGHT CURTAINS

<b>ECLASS 11.0</b>	27272704
<b>ECLASS 12.0</b>	27272704
<b>ETIM 5.0</b>	EC002549
<b>ETIM 6.0</b>	EC002549
<b>ETIM 7.0</b>	EC002549
<b>ETIM 8.0</b>	EC002549
<b>UNSPSC 16.0901</b>	46171620

### Dimensional drawing (Dimensions in mm (inch))

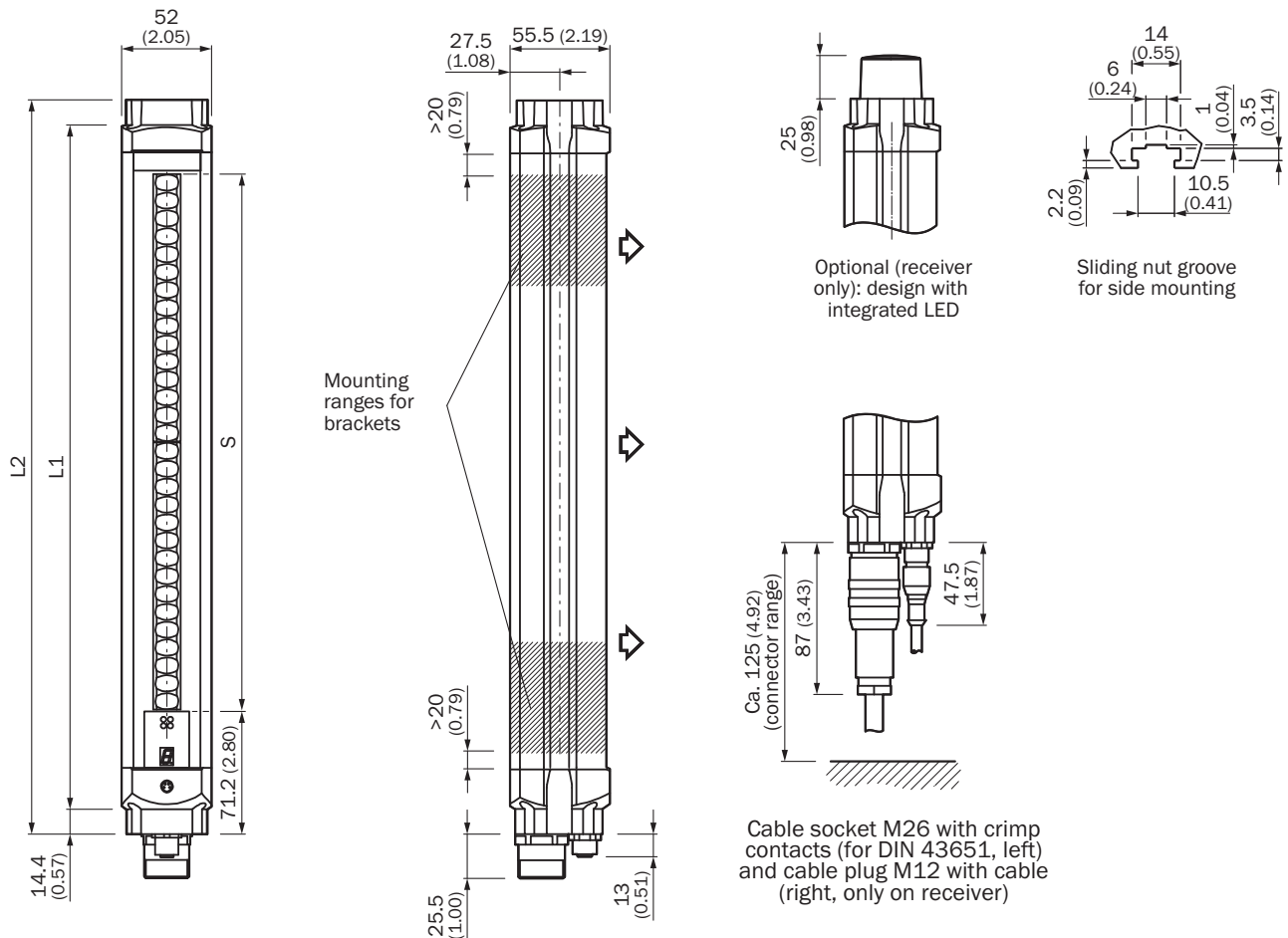







	<b>L1</b>	<b>L2</b>
300	387	416
450	537	566
600	687	716
750	837	866
900	987	1,016
1,050	1,137	1,166
1,200	1,287	1,316
1,350	1,437	1,466

	L1	L2
1,500	1,587	1,616
1,650	1,737	1,766
1,800	1,887	1,916

### Recommended accessories

Other models and accessories → [www.sick.com/M4000\\_Advanced\\_Curtain](http://www.sick.com/M4000_Advanced_Curtain)

	Brief description	Type	Part no.
<b>Alignment aids</b>			
	Laser alignment aid for various sensors, laser class 2 (IEC 60825). Do not look into the beam!, 19 mm x 67.3 mm x 66.9 mm	AR60	1015741
	Adapter AR60 for M4000 and M4000 Curtain	AR60 adapter, M4000	4040006
<b>Mounting brackets and plates</b>			
	4 pieces, Mounting kit 1, mounting bracket, rigid, L-shaped, including fixing screws and washers	BEF-3WNGBAST4	7021352
<b>Plug connectors and cables</b>			
	<ul style="list-style-type: none"> <li><b>Connection type head A:</b> Female connector, M26, 12-pin, straight</li> <li><b>Description:</b> Unshielded</li> <li><b>Connection systems:</b> Crimp contacts</li> <li><b>Permitted cross-section:</b> 0.5 mm<sup>2</sup> ... 1.5 mm<sup>2</sup></li> <li><b>Note:</b> 12 crimping contacts enclosed</li> </ul>	DOS-0612G000GA3KM0	6020757
<b>Terminal and alignment brackets</b>			
	4 pieces, Mounting kit 6, side bracket, rotatable, zinc diecast	BEF-1SHABAZN4	2019506
	4 pieces, Mounting kit 12, rotatable, swivel mount	BEF-2SMGEAKU4	2030510
<b>Others</b>			
	<ul style="list-style-type: none"> <li><b>Connection type head A:</b> Male connector, M8, 4-pin, straight</li> <li><b>Connection type head B:</b> Male connector, USB-A, straight</li> <li><b>Cable:</b> 10 m, 4-wire, PVC</li> <li><b>Description:</b> Unshielded, Configuration cable with integrated RS-232 transducer on USB for connecting a sensor configuration connection (M8, 4-pin) to the USB interface of a PC</li> </ul>	DSL-8U04G10M025KM1	6034575
	<ul style="list-style-type: none"> <li><b>Connection type head A:</b> Female connector, M26, 12-pin, straight</li> <li><b>Connection type head B:</b> Flying leads</li> <li><b>Signal type:</b> Sensor/actuator cable</li> <li><b>Cable:</b> 20 m, 12-wire, PVC</li> <li><b>Description:</b> Sensor/actuator cable, unshielded</li> <li><b>Connection systems:</b> Flying leads</li> </ul>	DOL-0612G20M075KM0	2022549

	Brief description	Type	Part no.
	<ul style="list-style-type: none"> <li>• <b>Connection type head A:</b> Male connector, M8, 4-pin, straight</li> <li>• <b>Connection type head B:</b> Male connector, USB-A, straight</li> <li>• <b>Cable:</b> 2 m, 4-wire, PVC</li> <li>• <b>Description:</b> Unshielded, Configuration cable with integrated RS-232 transducer on USB for connecting a sensor configuration connection (M8, 4-pin) to the USB interface of a PC</li> </ul>	DSL-8U04G02M025KM1	6034574
	<ul style="list-style-type: none"> <li>• <b>Connection type head A:</b> Female connector, M26, 12-pin, straight</li> <li>• <b>Connection type head B:</b> Flying leads</li> <li>• <b>Signal type:</b> Sensor/actuator cable</li> <li>• <b>Cable:</b> 15 m, 12-wire, PVC</li> <li>• <b>Description:</b> Sensor/actuator cable, unshielded</li> <li>• <b>Connection systems:</b> Flying leads</li> </ul>	DOL-0612G15M075KM0	2022548
	<ul style="list-style-type: none"> <li>• <b>Connection type head A:</b> Female connector, M26, 12-pin, straight</li> <li>• <b>Connection type head B:</b> Flying leads</li> <li>• <b>Signal type:</b> Sensor/actuator cable</li> <li>• <b>Cable:</b> 10 m, 12-wire, PVC</li> <li>• <b>Description:</b> Sensor/actuator cable, unshielded</li> <li>• <b>Connection systems:</b> Flying leads</li> </ul>	DOL-0612G10M075KM0	2022547
	<ul style="list-style-type: none"> <li>• <b>Connection type head A:</b> Female connector, M26, 12-pin, straight</li> <li>• <b>Connection type head B:</b> Flying leads</li> <li>• <b>Cable:</b> 5 m, PVC</li> <li>• <b>Description:</b> Unshielded</li> <li>• <b>Connection systems:</b> Flying leads</li> <li>• <b>Note:</b> Without EFI: Pin 9 and 10 not connected</li> </ul>	DOL-0610G05M075KM1	2046888
	<ul style="list-style-type: none"> <li>• <b>Connection type head A:</b> Female connector, M26, 12-pin, straight</li> <li>• <b>Connection type head B:</b> Flying leads</li> <li>• <b>Cable:</b> 10 m, PVC</li> <li>• <b>Description:</b> Unshielded</li> <li>• <b>Connection systems:</b> Flying leads</li> <li>• <b>Note:</b> Without EFI: Pin 9 and 10 not connected</li> </ul>	DOL-0610G10M075KM1	2046889
	<ul style="list-style-type: none"> <li>• <b>Connection type head A:</b> Female connector, M26, 12-pin, straight</li> <li>• <b>Connection type head B:</b> Flying leads</li> <li>• <b>Signal type:</b> Sensor/actuator cable</li> <li>• <b>Cable:</b> 5 m, 12-wire, PVC</li> <li>• <b>Description:</b> Sensor/actuator cable, unshielded</li> <li>• <b>Connection systems:</b> Flying leads</li> </ul>	DOL-0612G05M075KM0	2022545
Switching amplifiers			
	<ul style="list-style-type: none"> <li>• <b>Applications:</b> Muting switching amplifier</li> <li>• <b>Compatible sensor types:</b> M4000 Advanced multiple light beam safety devices</li> </ul>	UE403-A0930	1026287

## SICK AT A GLANCE

SICK is one of the leading manufacturers of intelligent sensors and sensor solutions for industrial applications. A unique range of products and services creates the perfect basis for controlling processes securely and efficiently, protecting individuals from accidents and preventing damage to the environment.

We have extensive experience in a wide range of industries and understand their processes and requirements. With intelligent sensors, we can deliver exactly what our customers need. In application centers in Europe, Asia and North America, system solutions are tested and optimized in accordance with customer specifications. All this makes us a reliable supplier and development partner.

Comprehensive services complete our offering: SICK LifeTime Services provide support throughout the machine life cycle and ensure safety and productivity.

For us, that is “Sensor Intelligence.”

## WORLDWIDE PRESENCE:

Contacts and other locations –[www.sick.com](http://www.sick.com)