



Product designation	Power contactor		
Product type designation	BG09		
Contact characteristics			
Number of poles	Nr.	4	
Rated insulation voltage U_i IEC/EN	V	690	
Rated impulse withstand voltage U_{imp}	kV	6	
Operational frequency	min	Hz	25
	max	Hz	400
IEC Conventional free air thermal current I_{th}	A	20	
Operational current I_e	AC-1 ($\leq 40^\circ\text{C}$)	A	20
	AC-1 ($\leq 55^\circ\text{C}$)	A	18
	AC-1 ($\leq 70^\circ\text{C}$)	A	15
	AC-3 ($\leq 440\text{V} \leq 55^\circ\text{C}$)	A	9
	AC-4 (400V)	A	4
Rated operational power AC-1 ($T \leq 40^\circ\text{C}$)	230V	kW	8
	400V	kW	14
	500V	kW	16
	690V	kW	22
IEC max current I_e in DC1 with $L/R \leq 1\text{ms}$ with 1 poles in series	$\leq 24\text{V}$	A	12
	48V	A	10
	75V	A	4
	110V	A	3
	220V	A	–
IEC max current I_e in DC1 with $L/R \leq 1\text{ms}$ with 2 poles in series	$\leq 24\text{V}$	A	15
	48V	A	14
	75V	A	9
	110V	A	8
	220V	A	–
IEC max current I_e in DC1 with $L/R \leq 1\text{ms}$ with 3 poles in series	$\leq 24\text{V}$	A	16
	48V	A	16
	75V	A	10
	110V	A	10
	220V	A	2
IEC max current I_e in DC1 with $L/R \leq 1\text{ms}$ with 4 poles in series	$\leq 24\text{V}$	A	16
	48V	A	16
	75V	A	10
	110V	A	10
	220V	A	2

IEC max current I_e in DC3-DC5 with $L/R \leq 15\text{ms}$ with 1 poles in series	$\leq 24\text{V}$	A	7	
	48V	A	6	
	75V	A	2	
	110V	A	1	
	220V	A	–	
	IEC max current I_e in DC3-DC5 with $L/R \leq 15\text{ms}$ with 2 poles in series	$\leq 24\text{V}$	A	8
48V		A	8	
75V		A	5	
110V		A	4	
220V		A	–	
IEC max current I_e in DC3-DC5 with $L/R \leq 15\text{ms}$ with 3 poles in series		$\leq 24\text{V}$	A	10
	48V	A	10	
	75V	A	6	
	110V	A	5	
	220V	A	0,8	
	IEC max current I_e in DC3-DC5 with $L/R \leq 15\text{ms}$ with 4 poles in series	$\leq 24\text{V}$	A	10
48V		A	10	
75V		A	6	
110V		A	5	
220V		A	0,8	
Short-time allowable current for 10s (IEC/EN60947-1)			A	96
Protection fuse	gG (IEC)	A	20	
	aM (IEC)	A	10	
Making capacity (RMS value)		A	92	
Breaking capacity at voltage	440V	A	72	
	500V	A	72	
	690V	A	72	
Resistance per pole (average value)		m Ω	10	
Power dissipation per pole (average value)	I_{th}	W	4	
	AC-3	W	0.81	
Tightening torque for terminals	min	Nm	0.8	
	max	Nm	1	
	min	Ibin	9	
	max	Ibin	9	
Tightening torque for coil terminal	min	Nm	0.8	
	max	Nm	1	
	min	Ibin	9	
	max	Ibin	9	
Max number of wires simultaneously connectable		Nr.	2	
Conductor section	AWG/Kcmil			
	max		12	
	Flexible w/o lug conductor section			
	min	mm ²	0.75	

		max	mm ²	2.5
Flexible c/w lug conductor section		min	mm ²	1.5
		max	mm ²	2.5
Flexible with insulated spade lug conductor section		min	mm ²	1.5
		max	mm ²	2.5
Power terminal protection according to IEC/EN 60529				IP20 when properly wired
Mechanical features				
Operating position		normal allowable		Vertical plan ±30°
Fixing				Screw / DIN rail 35mm
Weight			g	224
Conductor section	AWG/kcmil conductor section	max		12
Auxiliary contact characteristics				
Thermal current I _{th}			A	10
IEC/EN 60947-5-1 designation				Q600
Operations				
Mechanical life			cycles	20000000
Electrical life			cycles	500000
Safety related data				
Performance level B10d according to EN/ISO 13489-1		rated load	cycles	500000
		mechanical load	cycles	20000000
Mirror contacts according to IEC/EN 60947-4-1				yes
EMC compatibility				yes
DC coil operating				
DC rated control voltage			V	125
DC operating voltage	pick-up	min	%U _s	75
		max	%U _s	115
	drop-out	min	%U _s	10
		max	%U _s	25
Average coil consumption ≤20°C		in-rush	W	3.2
		holding	W	3.2
Max cycles frequency				
Mechanical operation			cycles/h	3600
Operating times				
Average time for U _s control in AC	Closing NO	min	ms	12
		max	ms	21
	Opening NO	min	ms	9
		max	ms	18

	Closing NC	min	ms	17
		max	ms	26
	Opening NC	min	ms	7
		max	ms	17
in DC				
	Closing NO	min	ms	18
		max	ms	25
	Opening NO	min	ms	2
		max	ms	3
	Closing NC	min	ms	3
		max	ms	5
	Opening NC	min	ms	11
		max	ms	17

UL technical data

Full-load current (FLA) for three-phase AC motor

at 480V	A	7.6
at 600V	A	6.1

Yielded mechanical performance

for single-phase AC motor

110/120V	HP	0.5
230V	HP	1.5

for three-phase AC motor

200/208V	HP	2
220/230V	HP	3
460/480V	HP	5
575/600V	HP	5

General USE

Contactor

AC current	A	20
------------	---	----

Short-circuit protection fuse, 600V

High fault

Short circuit current	kA	100
Fuse rating	A	30
Fuse class		J

Standard fault

Short circuit current	kA	5
Fuse rating	A	30
Fuse class		RK5

Ambient conditions

Temperature

Operating temperature

min	°C	-50
max	°C	+70

Storage temperature

min	°C	-60
max	°C	+80

Max altitude

m	3000
---	------

Resistance & Protection

Pollution degree

3

Dimensions

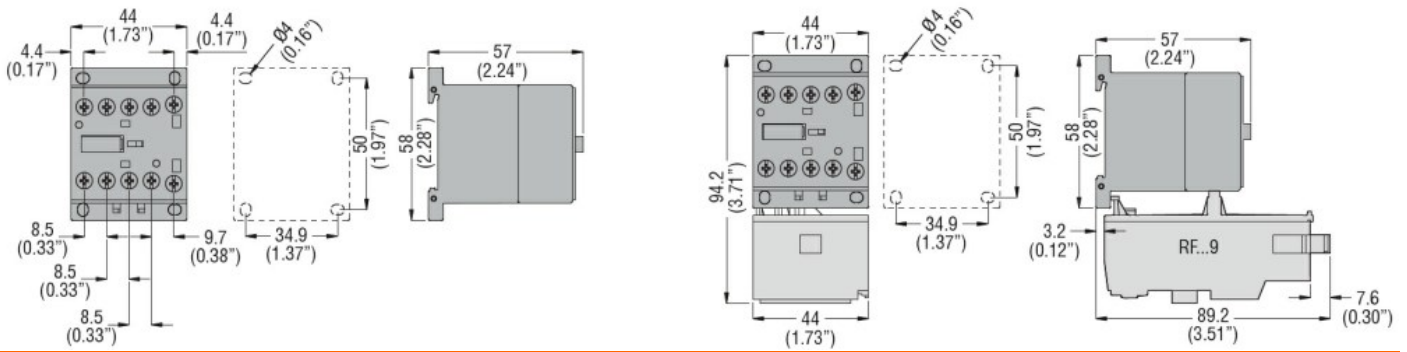

Wiring diagrams

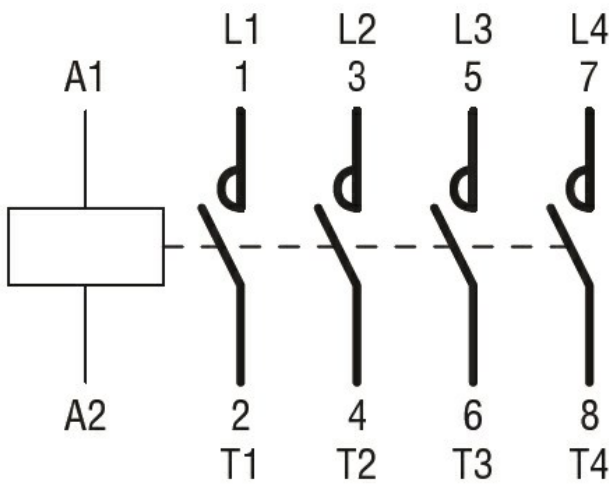

Certifications and compliance

Compliance

CSA C22.2 n° 60947-1
CSA C22.2 n° 60947-4-1
IEC/EN 60947-1
IEC/EN 60947-4-1
UL 60947-1
UL 60947-4-1

Certificates

CCC
cULus
EAC

ETIM classification

ETIM 8.0

EC000066 -
Power contactor,
AC switching