

ML-614

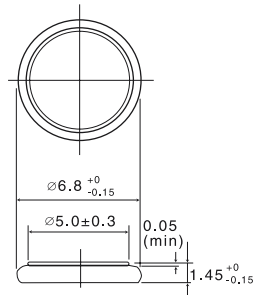

SPECIFICATIONS

Name	ML-614
Nominal voltage (V)	3
Nominal capacity (mAh)	3.4
Continuous drain (mA)	0.01
Operating temperature (°C)	-20 to +60
Weight (g)	0.16

DISCHARGE CHARACTERISTICS

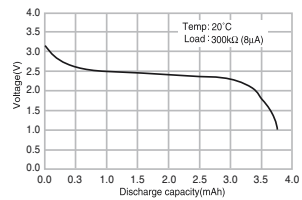

CONSUMPTION CURRENT VS. DURATION TIME

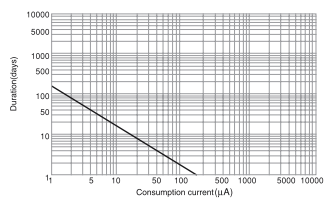

ML-621

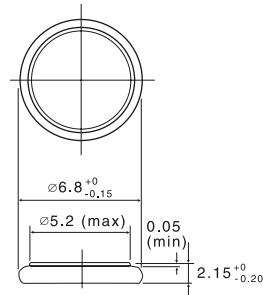

SPECIFICATIONS

Name	ML-621
Nominal voltage (V)	3
Nominal capacity (mAh)	5.0
Continuous drain (mA)	0.01
Operating temperature (°C)	-20 to +60
Weight (g)	0.23

DISCHARGE CHARACTERISTICS

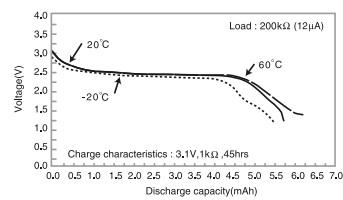

CHARGE CHARACTERISTICS

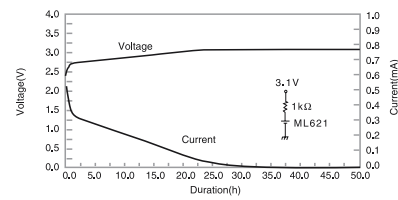

CONSUMPTION CURRENT VS. DURATION TIME

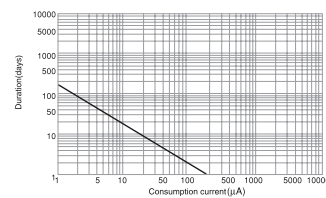

ML-920

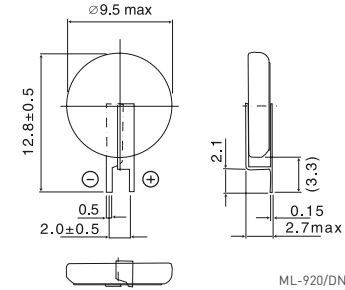

ML-920/DN

SPECIFICATIONS

Name	ML-920
Nominal voltage (V)	3
Nominal capacity (mAh)	11.0
Continuous drain (mA)	0.03
Operating temperature (°C)	-20 to +60
Weight (g)	0.4

DISCHARGE CHARACTERISTICS

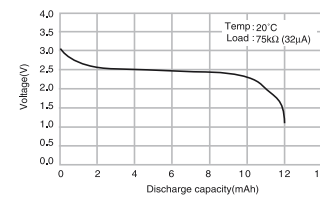

CONSUMPTION CURRENT VS. DURATION TIME

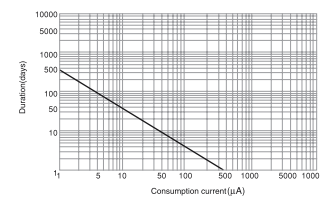

ML-1220

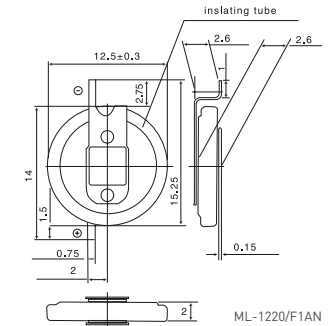

ML-1220/F1AN

SPECIFICATIONS

Name	ML-1220
Nominal voltage (V)	3
Nominal capacity (mAh)	17.0
Continuous drain (mA)	0.03
Operating temperature (°C)	-20 to +60
Weight (g)	0.8

DISCHARGE CHARACTERISTICS

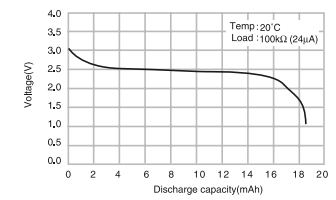

CONSUMPTION CURRENT VS. DURATION TIME

