



Product designation				Power contactor
Product type designation				BF09
<b>Contact characteristics</b>				
Number of poles	Nr.			4
Rated insulation voltage U <sub>i</sub> IEC/EN	V			690
Rated impulse withstand voltage U <sub>imp</sub>	kV			6
Operational frequency	min	Hz	25	
	max	Hz	400	
IEC Conventional free air thermal current I <sub>th</sub>	A			25
Operational current I <sub>e</sub>	AC-1 (≤40°C)	A	25	
	AC-1 (≤55°C)	A	20	
	AC-1 (≤70°C)	A	18	
	AC-3 (≤440V ≤55°C)	A	9	
	AC-4 (400V)	A	4.9	
Rated operational power AC-1 (T≤40°C)	230V	kW	9.5	
	400V	kW	16	
	500V	kW	21	
	690V	kW	27	
Short-time allowable current for 10s (IEC/EN60947-1)	A			150
Protection fuse	gG (IEC)	A	25	
	aM (IEC)	A	10	
Making capacity (RMS value)	A			90
Breaking capacity at voltage	440V	A	72	
	500V	A	72	
	690V	A	71	
Resistance per pole (average value)	mΩ			2.5
Power dissipation per pole (average value)	I <sub>th</sub>	W	1.6	
	AC-3	W	0.2	
Tightening torque for terminals	min	Nm	1.5	
	max	Nm	1.8	
	min	I <sub>bin</sub>	1.1	
	max	I <sub>bin</sub>	1.5	
Tightening torque for coil terminal	min	Nm	0.8	
	max	Nm	1	
	min	I <sub>bin</sub>	0.8	
	max	I <sub>bin</sub>	0.74	
Max number of wires simultaneously connectable	Nr.			2

Conductor section	AWG/Kcmil			
		max		10
Flexible w/o lug conductor section		min	mm <sup>2</sup>	1
		max	mm <sup>2</sup>	6
Flexible c/w lug conductor section		min	mm <sup>2</sup>	1
		max	mm <sup>2</sup>	4
Flexible with insulated spade lug conductor section		min	mm <sup>2</sup>	1
		max	mm <sup>2</sup>	4

Power terminal protection according to IEC/EN 60529 IP20 when properly wired

**Mechanical features**

Operating position	normal allowable	Vertical plan ±30°
Fixing		Screw / DIN rail 35mm
Weight		g 348

Conductor section	AWG/kcmil conductor section		
		max	10

**Operations**

Mechanical life		cycles	20000000
Electrical life		cycles	2000000

**Safety related data**

Performance level B10d according to EN/ISO 13489-1	rated load mechanical load	cycles	2000000
		cycles	20000000
Mirror contacts according to IEC/EN 60947-4-1			YES
EMC compatibility			yes

**AC coil operating**

Rated AC voltage at 60Hz		V	230
AC operating voltage	of 60Hz coil powered at 60Hz		
	pick-up	min %Us	80
		max %Us	110
	drop-out	min %Us	20
		max %Us	55

AC average coil consumption at 20°C	of 60Hz coil powered at 60Hz		
		in-rush holding	VA 75
			VA 9

Dissipation at holding ≤20°C 50Hz		W	2.5
-----------------------------------	--	---	-----

**Max cycles frequency**

Mechanical operation		cycles/h	3600
----------------------	--	----------	------

**Operating times**

Average time for Us control in AC			
-----------------------------------	--	--	--

Closing NO	min	ms	8
	max	ms	24
Opening NO	min	ms	10
	max	ms	20
Closing NC	min	ms	14
	max	ms	28
Opening NC	min	ms	7
	max	ms	18

**UL technical data**

Full-load current (FLA) for three-phase AC motor

at 480V	A	7.6
at 600V	A	9

Yielded mechanical performance

for single-phase AC motor

110/120V	HP	0.8
230V	HP	2

for three-phase AC motor

200/208V	HP	3
220/230V	HP	3
460/480V	HP	5
575/600V	HP	7.5

General USE

Contactor

AC current	A	25
------------	---	----

**Ambient conditions**

Temperature

Operating temperature

min	°C	-50
max	°C	70

Storage temperature

min	°C	-60
max	°C	80

Max altitude

m	3000
---	------

**Resistance & Protection**

Pollution degree

3

**Dimensions**

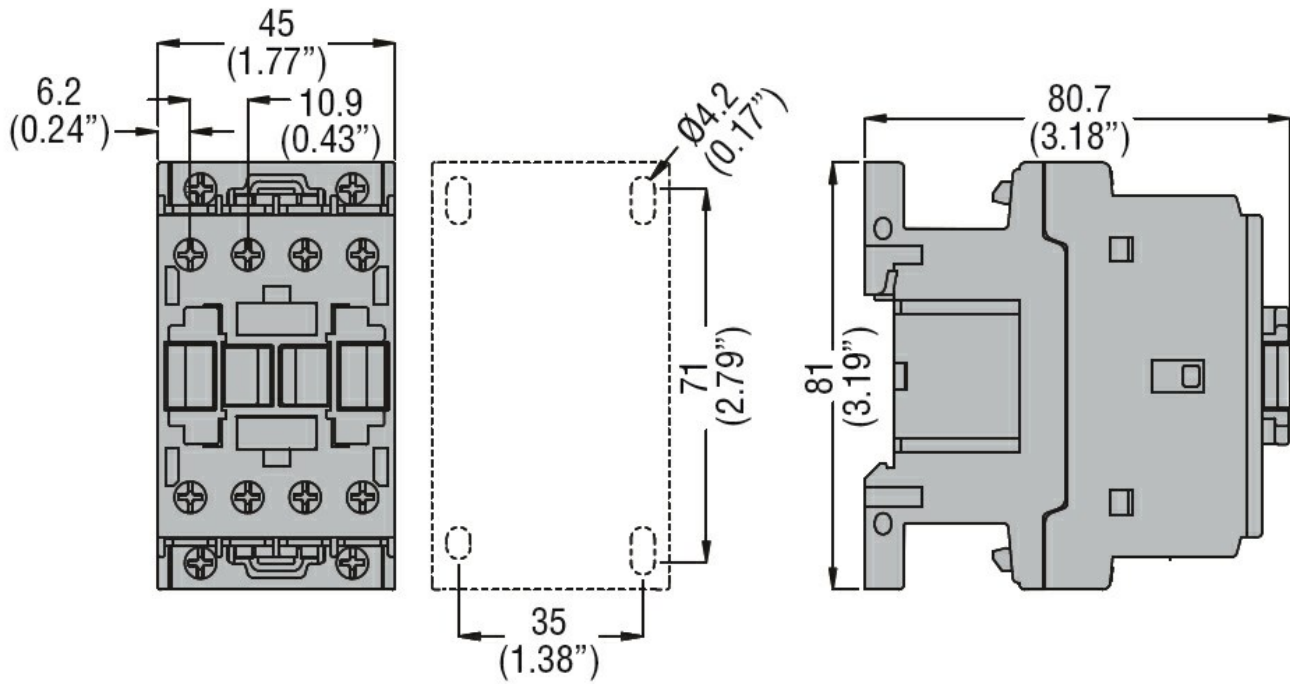

### Wiring diagrams

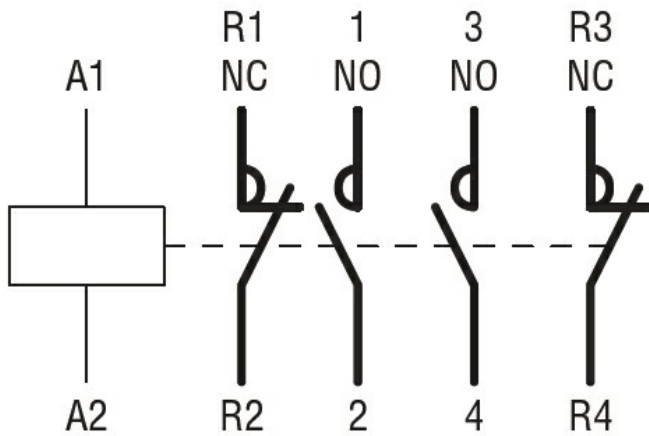

### Certifications and compliance

#### Compliance

CSA C22.2 n° 60947-1  
CSA C22.2 n° 60947-4-1  
IEC/EN/BS 60947-1  
IEC/EN/BS 60947-4-1  
UL 60947-1  
UL 60947-4-1

#### Certificates

CCC  
cULus  
EAC

### ETIM classification

ETIM 8.0

EC000066 -  
Power contactor,  
AC switching