

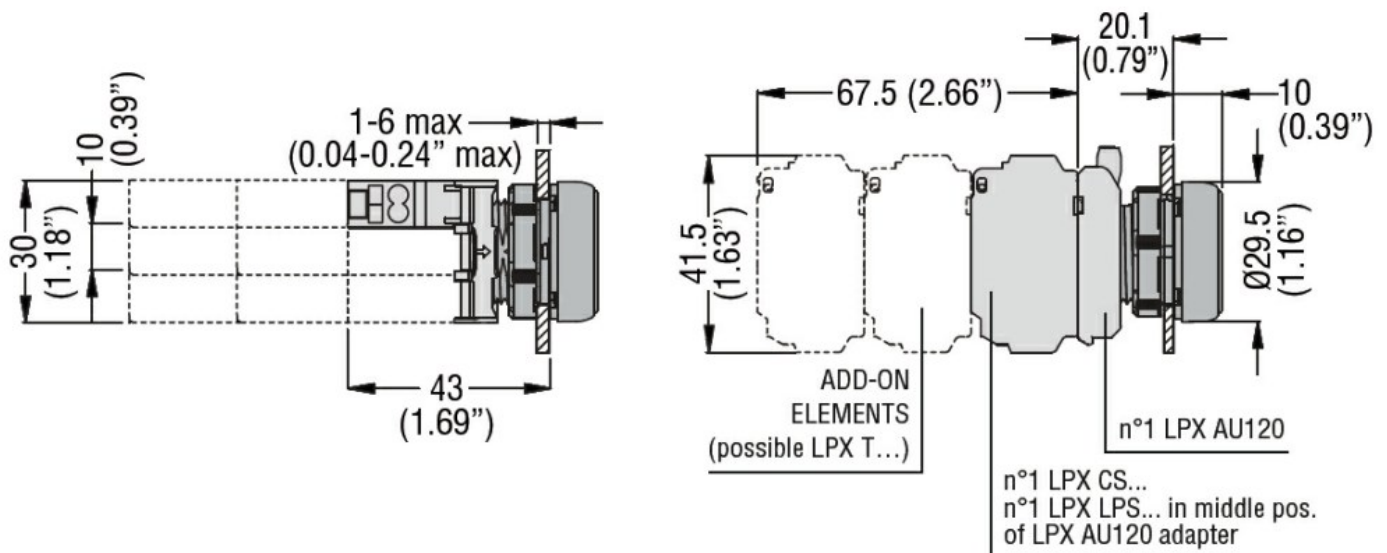

Product designation	LED elements steady light		
Product type designation	LPXLF		
<b>General characteristics</b>			
Colour	White		
<b>Electrical characteristics</b>			
Supply voltage (AC)	V	85...140	
<b>Operations</b>			
Electrical life	hours	100000	
<b>Mechanical features</b>			
Tightening torque for terminals max	Nm	1	
Conductor section			
AWG/kcmil conductor section	max	12	
IEC	max	mm <sup>2</sup>	1 or 2 / 2.5
Mounting adapter	LPXAU120		
Weight	g	16	
<b>Ambient conditions</b>			
Temperature			
Operating temperature	min	°C	-25
	max	°C	+70
Storage temperature	min	°C	-40
	max	°C	+85

**Dimensions**



**Wiring diagrams**

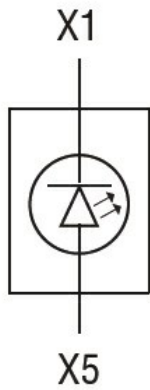

### Certifications and compliance

#### Compliance

CSA C22.2 n° 14  
IEC/EN/BS 60947-1  
IEC/EN/BS 60947-5-1  
UL508

#### Certificates

CCC  
cULus  
EAC  
RINA  
UL

### ETIM classification

ETIM 8.0

EC000204 -  
Lamp holder  
block for control  
circuit devices