



Product designation Power contactor
Product type designation B400

Contact characteristics

Number of poles	Nr.	3
Rated insulation voltage U_i IEC/EN	V	1000
Rated impulse withstand voltage U_{imp}	kV	8
Operational frequency	min	Hz 25
	max	Hz 400
IEC Conventional free air thermal current I_{th}	A	550
Operational current I_e	AC-1 ($\leq 40^\circ\text{C}$)	A 550
	AC-1 ($\leq 55^\circ\text{C}$)	A 430
	AC-1 ($\leq 70^\circ\text{C}$)	A 360
	AC-3 ($\leq 440\text{V} \leq 55^\circ\text{C}$)	A 420
	AC-4 (400V)	A 200
Rated operational power AC-3 ($T \leq 55^\circ\text{C}$)	230V	kW 130
	400V	kW 225
	415V	kW 247
	440V	kW 263
	500V	kW 271
	690V	kW 352
	1000V	kW 208
Rated operational power AC-1 ($T \leq 40^\circ\text{C}$)	230V	kW 200
	400V	kW 345
	500V	kW 452
	690V	kW 598
IEC max current I_e in DC1 with $L/R \leq 1\text{ms}$ with 1 poles in series	75V	A 400
	110V	A 250
	220V	A --
	330V	A --
	460V	A --
IEC max current I_e in DC1 with $L/R \leq 1\text{ms}$ with 2 poles in series	75V	A 400
	110V	A 400
	220V	A 350
	330V	A --
	460V	A --
IEC max current I_e in DC1 with $L/R \leq 1\text{ms}$ with 3 poles in series	75V	A 400
	110V	A 400
	220V	A 400

	330V	A	350
	460V	A	--
IEC max current I _e in DC1 with L/R ≤ 1ms with 4 poles in series			
	75V	A	400
	110V	A	400
	220V	A	400
	330V	A	400
	460V	A	350
IEC max current I _e in DC3-DC5 with L/R ≤ 15ms with 1 poles in series			
	75V	A	350
	110V	A	200
	220V	A	--
	330V	A	--
	460V	A	--
IEC max current I _e in DC3-DC5 with L/R ≤ 15ms with 2 poles in series			
	75V	A	350
	110V	A	350
	220V	A	280
	330V	A	--
	460V	A	--
IEC max current I _e in DC3-DC5 with L/R ≤ 15ms with 3 poles in series			
	75V	A	350
	110V	A	350
	220V	A	350
	330V	A	280
	460V	A	--
IEC max current I _e in DC3-DC5 with L/R ≤ 15ms with 4 poles in series			
	75V	A	350
	110V	A	350
	220V	A	350
	330V	A	280
	460V	A	280
Short-time allowable current for 10s (IEC/EN60947-1)		A	3600
Protection fuse			
	gG (IEC)	A	630
	aM (IEC)	A	400
Making capacity (RMS value)		A	4200
Breaking capacity at voltage			
	440V	A	4000
	500V	A	3400
	690V	A	3360
Resistance per pole (average value)		mΩ	0.2
Power dissipation per pole (average value)			
	I _{th}	W	52
	AC-3	W	32
Tightening torque for terminals			
	min	Nm	35
	max	Nm	35
	min	I _{bin}	25.8
	max	I _{bin}	25.8
Tightening torque for coil terminal			
	min	Nm	1
	max	Nm	1

	min	I _{bin}	0.74
	max	I _{bin}	0.74
Max number of wires simultaneously connectable		Nr.	2
Conductor section			
		AWG/Kcmil	
	max		2x 300 kcmil
Power terminal protection according to IEC/EN 60529			IP00
Mechanical features			
Operating position		normal allowable	Vertical plan ±30°
Fixing			Screw
Weight		g	9620
Conductor section			
		AWG/kcmil conductor section	
	max		2x 300 kcmil
Operations			
Mechanical life		cycles	10000000
Electrical life		cycles	700000
Safety related data			
Performance level B10d according to EN/ISO 13489-1		rated load mechanical load	cycles 700000 cycles 10000000
Mirror contacts according to IEC/EN 60947-4-1			yes
EMC compatibility			yes
AC coil operating			
Rated AC voltage at 50/60Hz, 60Hz		min	V 110
		max	V 125
AC operating voltage			
		of 50/60Hz coil powered at 50Hz	
		pick-up	
	min	%Us	80
	max	%Us	110
		drop-out	
	min	%Us	20
	max	%Us	60
		of 50/60Hz coil powered at 60Hz	
		pick-up	
	min	%Us	80
	max	%Us	110
		drop-out	
	min	%Us	20
	max	%Us	60
		of 60Hz coil powered at 60Hz	
		pick-up	
	min	%Us	80
	max	%Us	110
		drop-out	
	min	%Us	20
	max	%Us	60
AC average coil consumption at 20°C			
		of 50/60Hz coil powered at 50Hz	

	in-rush	VA	300
	holding	VA	10
of 50/60Hz coil powered at 60Hz			
	in-rush	VA	300
	holding	VA	10
Dissipation at holding $\leq 20^{\circ}\text{C}$ 50Hz		W	10
DC coil operating			
DC rated control voltage			
	min	V	110
	max	V	125
DC operating voltage			
pick-up			
	min	%Us	80
	max	%Us	110
drop-out			
	min	%Us	20
	max	%Us	60
Average coil consumption $\leq 20^{\circ}\text{C}$			
	in-rush	W	300
	holding	W	10
Max cycles frequency			
Mechanical operation		cycles/h	2400
Operating times			
Average time for Us control			
in AC			
Closing NO			
	min	ms	80
	max	ms	120
Opening NO			
	min	ms	30
	max	ms	75
in DC			
Closing NO			
	min	ms	80
	max	ms	120
Opening NO			
	min	ms	30
	max	ms	75
UL technical data			
Full-load current (FLA) for three-phase AC motor			
	at 480V	A	414
	at 600V	A	382
Yielded mechanical performance			
for three-phase AC motor			
	200/208V	HP	125
	220/230V	HP	150
	460/480V	HP	350
	575/600V	HP	400
General USE			
Contactor			
	AC current	A	550
Short-circuit protection fuse, 600V			
Standard fault			
	Short circuit current	kA	18

Fuse rating	A	800
Fuse class		L

Ambient conditions

Temperature

Operating temperature

min	°C	-50
max	°C	70

Storage temperature

min	°C	-60
max	°C	80

Max altitude

m	3000
---	------

Resistance & Protection

Pollution degree

3

Dimensions

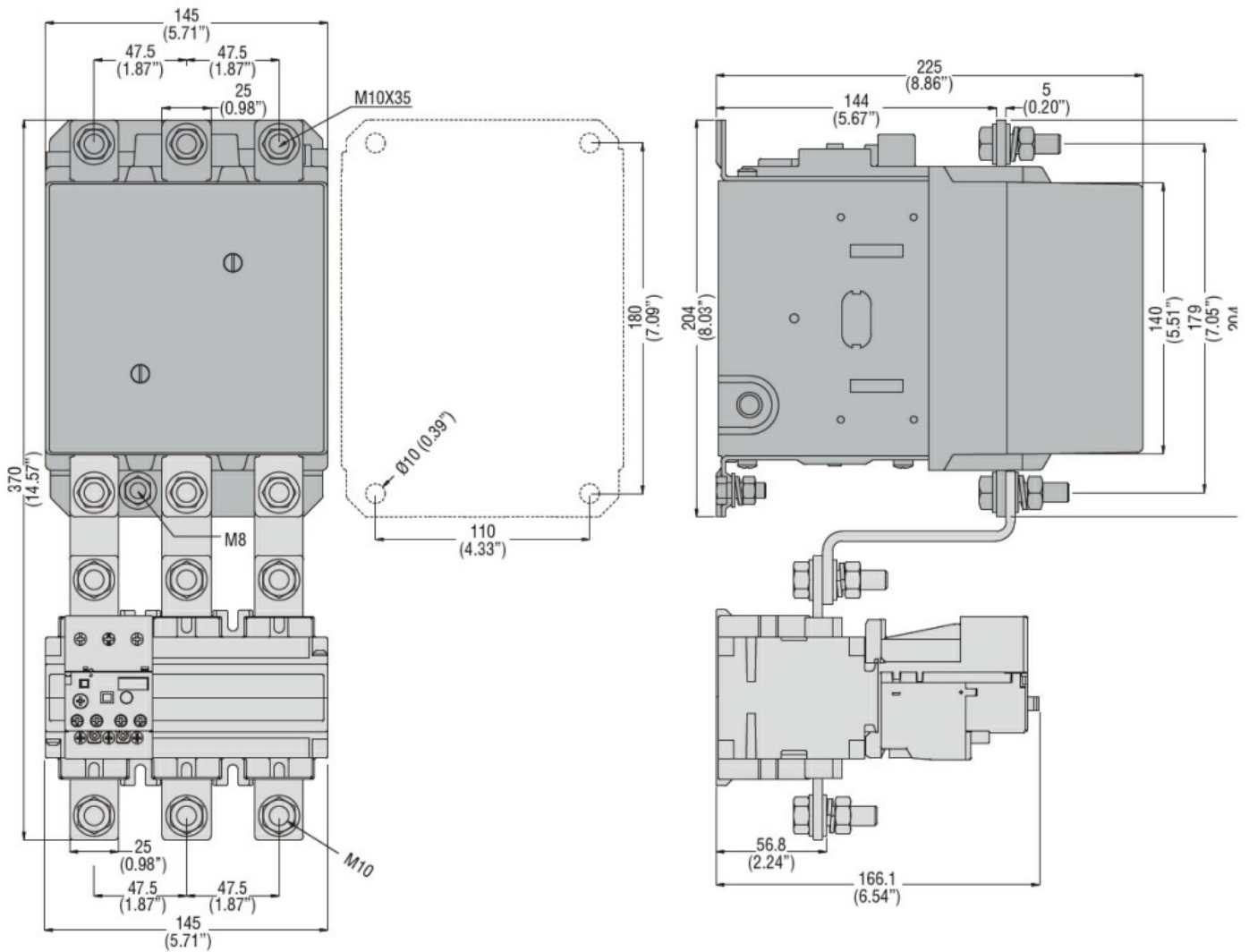

Wiring diagrams

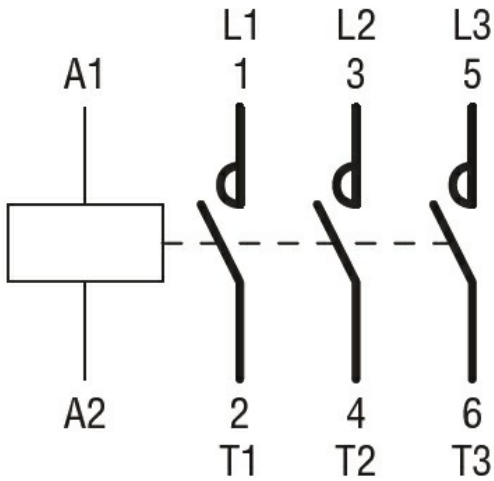

Certifications and compliance

Compliance

CSA C22.2 n° 60947-1

CSA C22.2 n° 60947-4-1

IEC/EN 60947-1

IEC/EN 60947-4-1

UL 60947-1

UL 60947-4-1

Certificates

CCC

cULus

EAC

ETIM classification

ETIM 8.0

EC000066 -
 Power contactor,
 AC switching