

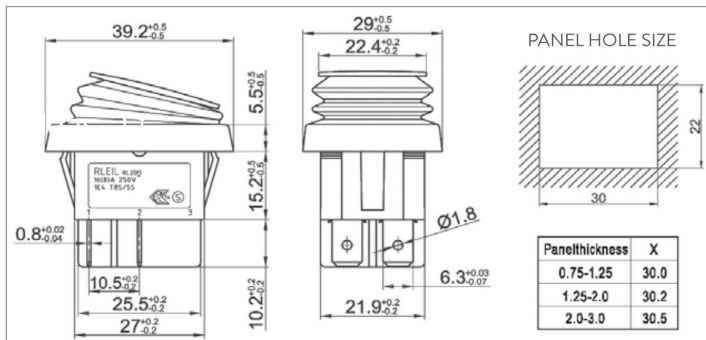

RL-2P-21/N-C-2-RE/BK-P1-2









MOQ: 5K

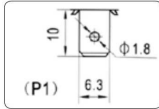

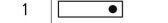
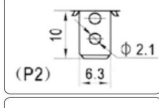
16 (8)A 250VAC T85/55 1E4
16A 125VAC
10A 250VAC
3/4 HP 125/250VAC T80

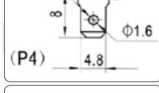
RL-2P

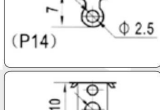
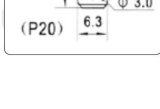
RL-2P	21/N	C	2	BK/BK	P1	(2)
Function	Cap type	Cap Printing	Cap colour / Housing	Terminals	Voltage	
00	Indicator lamp 2T	C Soft line	0 None	WT White	 (P1) 6.3	1 110VAC
21	ON - OFF 4T	I Indicator lamp	1 	BK Black		2 220VAC
21/N	ON - OFF - 4T w/lamp		2 	RE Red	 (P2) 6.3	3 12VDC
21(ON)	(ON) - OFF 4T		3 	OR Orange		4 24VDC
22	ON - ON 6T		4 	GR Green	 (P4) 4.8	
22/N	ON-ON 6T		5 	BL Blue		
23	ON - OFF - ON 6T		X Custom	GE Grey	 (P14) 2.5	
23(ON)	(ON) - OFF - ON 6T					
23(2xON)	(ON) - OFF - (ON) 6T				 (P20) 6.3	

