



# AFM60S-S4SC262144

AFS/AFM60S Pro

**ABSOLUTE ENCODERS**

**SICK**  
Sensor Intelligence.

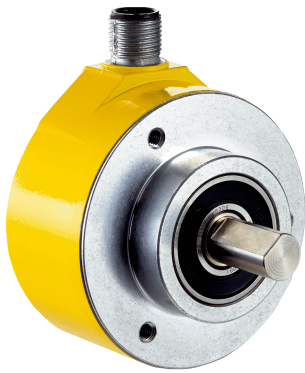

Illustration may differ



### Ordering information

Type	Part no.
AFM60S-S4SC262144	1104950

Other models and accessories → [www.sick.com/AFS\\_AFM60S\\_Pro](http://www.sick.com/AFS_AFM60S_Pro)

### Detailed technical data

#### Safety-related parameters

<b>Safety integrity level</b>	SIL 3 (IEC 61508, IEC 61800-5-3) <sup>1)</sup>
<b>Performance level</b>	PL e (EN ISO 13849-1) <sup>1)</sup>
<b>Category</b>	3 (EN ISO 13849-1) 4 (EN ISO 13849-1)
<b>PFH<sub>D</sub>: Probability of dangerous failure per hour</b>	5.5 x 10 <sup>-9</sup> at 40 °C <sup>2)</sup> 1.8 x 10 <sup>-8</sup> at 80 °C <sup>2)</sup>
<b>T<sub>M</sub> (mission time)</b>	20 years (EN ISO 13849-1) <sup>3)</sup>
<b>Safety-related accuracy</b>	0.09° category 3 <sup>4)</sup> 0.35° category 4 <sup>4)</sup>

<sup>1)</sup> For more detailed information on the exact configuration of your machine/unit, please consult your relevant SICK branch office.

<sup>2)</sup> The values displayed apply to a the temperature at the operating temperature measuring point and diagnostic degree of coverage of 99%, which must be achieved by the external evaluation unit.

<sup>3)</sup> Depending on the application, the operating life may also be limited by the bearing lifetime.

<sup>4)</sup> The safety-related accuracy indicates the maximum positioning error limit with which the safety functions can be supported.

#### Performance

<b>Number of steps per revolution (max. resolution)</b>	262,144 (18 bit)
<b>Number of revolutions</b>	4,096 (12 bit)
<b>Max. resolution (number of steps per revolution x number of revolutions)</b>	18 bit x 12 bit (262,144 x 4,096)
<b>Error limits G</b>	0.05° <sup>1)</sup>

<sup>1)</sup> In accordance with DIN ISO 1319-1, position of the upper and lower error limit depends on the installation situation, specified value refers to a symmetrical position, i.e. deviation in upper and lower direction is the same.

#### Interfaces

<b>Communication interface</b>	SSI
--------------------------------	-----

<sup>1)</sup> Valid signals can be read once this time has elapsed.

<sup>2)</sup> Set on tool side: CW with view to the shaft.

<b>Communication Interface detail</b>	SSI + Sin/Cos
<b>Initialization time</b>	2 s <sup>1)</sup>
<b>Position forming time</b>	< 1 µs
<b>Parameterising data</b>	Number of steps per revolution Preset position, preset position via hardware pin, counting direction, counting direction via hardware pin, reset factory setting, read out error memory, generate report
<b>Code type</b>	Gray
<b>Code sequence parameter adjustable</b>	CW/CCW configurable <sup>2)</sup>
<b>Clock frequency</b>	100 kHz, ≤ 1 MHz
<b>Set (electronic adjustment)</b>	H-active (L = 0 - 1,5 V, H = 2,0 - Us V)
<b>CW/CCW (counting sequence when turning)</b>	L-active (L = 0 - 1,5 V, H = 2,0 - Us V)
<b>Sine/cosine periods per revolution</b>	1,024
<b>Output frequency</b>	≤ 153.6 kHz
<b>Load resistance</b>	≥ 120 Ω
<b>Signal before differential generation</b>	0.5 V <sub>pp</sub> , ± 20 %
<b>Signal offset before differential generation</b>	2.5 V ± 10 %
<b>Signal after differential generation</b>	1 V <sub>pp</sub> , ± 20 %

<sup>1)</sup> Valid signals can be read once this time has elapsed.

<sup>2)</sup> Set on tool side: CW with view to the shaft.

## Electrical data

<b>Connection type</b>	Male connector, M12, 12-pin, radial
<b>Supply voltage</b>	4.5 ... 30 V
<b>Power consumption</b>	0.7 W (without load)
<b>Reverse polarity protection</b>	✓
<b>Short-circuit protection</b>	✓ <sup>1)</sup>

<sup>1)</sup> SinCos interface: Short-circuit to another channel or GND permitted for max. 30 sec. In the case of  $U_S \leq 12$  V additional short-circuit to  $U_S$  permitted for max. 30 sec.

SSI interface: Short-circuit to another channel or GND permitted for max. 30 s. In the case of  $U_S \leq 5$  V, additional short-circuit to  $U_S$  permitted for max. 30 s.

## Mechanical data

<b>Mechanical design</b>	Solid shaft, face mount flange
<b>Shaft diameter</b>	10 mm
<b>Shaft length</b>	19 mm
<b>Weight</b>	0.3 kg <sup>1)</sup>
<b>Shaft material</b>	Stainless steel
<b>Flange material</b>	Aluminum
<b>Material, stator coupling</b>	Stainless steel
<b>Housing material</b>	Aluminum die cast
<b>Start up torque</b>	≤ 0.5 Ncm (+20 °C)

<sup>1)</sup> Based on devices with male connector.

<sup>2)</sup> Depending on the application, the operating life may also be limited by the bearing lifetime.

<sup>3)</sup> The value corresponds to  $L_{10mr}$  (ISO/TS 16281) at 10 °C up to 60 °C operating temperature, speed > 10 U/min, at max. permitted shaft load / shaft movement.

<b>Operating torque</b>	≤ 0.3 Ncm (+20 °C)
<b>Permissible shaft loading</b>	80 N (radial) 40 N (axial)
<b>Operating speed</b>	≤ 9,000 min <sup>-1</sup>
<b>Moment of inertia of the rotor</b>	8 gcm <sup>2</sup>
<b>Bearing lifetime</b>	3.6 x 10 <sup>9</sup> revolutions <sup>2) 3)</sup>
<b>Angular acceleration</b>	≤ 500,000 rad/s <sup>2</sup>

<sup>1)</sup> Based on devices with male connector.

<sup>2)</sup> Depending on the application, the operating life may also be limited by the bearing lifetime.

<sup>3)</sup> The value corresponds to L<sub>10mr</sub> (ISO/TS 16281) at 10 °C up to 60 °C operating temperature, speed > 10 U/min, at max. permitted shaft load / shaft movement.

### Ambient data

<b>EMC</b>	EN 61000-6-2, EN 61000-6-3, EN 61000-6-7
<b>Enclosure rating</b>	IP65 (IEC 60529)
<b>Permissible relative humidity</b>	90 % (Condensation not permitted)
<b>Operating temperature range</b>	-30 °C ... +85 °C <sup>1)</sup>
<b>Storage temperature range</b>	-30 °C ... +85 °C, without package
<b>Resistance to shocks</b>	100 g, 6 ms (according to EN 60068-2-27) <sup>2)</sup>
<b>Resistance to vibration</b>	30 g, 10 Hz ... 1,000 Hz (EN 60068-2-6) <sup>2)</sup>
<b>Operating height (above sea level)</b>	≤ 2,000 m (80 kPa)
<b>Protection class</b>	III (according to DIN EN 61140)
<b>Contamination rating</b>	2 (IEC 60664-1)

<sup>1)</sup> At operating temperature measuring point.

<sup>2)</sup> Tested during operation within the safety-related accuracy.

### Classifications

<b>eCl@ss 5.0</b>	27270502
<b>eCl@ss 5.1.4</b>	27270502
<b>eCl@ss 6.0</b>	27270590
<b>eCl@ss 6.2</b>	27270590
<b>eCl@ss 7.0</b>	27270502
<b>eCl@ss 8.0</b>	27270502
<b>eCl@ss 8.1</b>	27270502
<b>eCl@ss 9.0</b>	27270502
<b>eCl@ss 10.0</b>	27270502
<b>eCl@ss 11.0</b>	27270502
<b>eCl@ss 12.0</b>	27270502
<b>ETIM 5.0</b>	EC001486
<b>ETIM 6.0</b>	EC001486
<b>ETIM 7.0</b>	EC001486
<b>ETIM 8.0</b>	EC001486
<b>UNSPSC 16.0901</b>	41112113

Dimensional drawing (Dimensions in mm (inch))

Solid shaft, face mount flange, M12 and M23 radial male connector

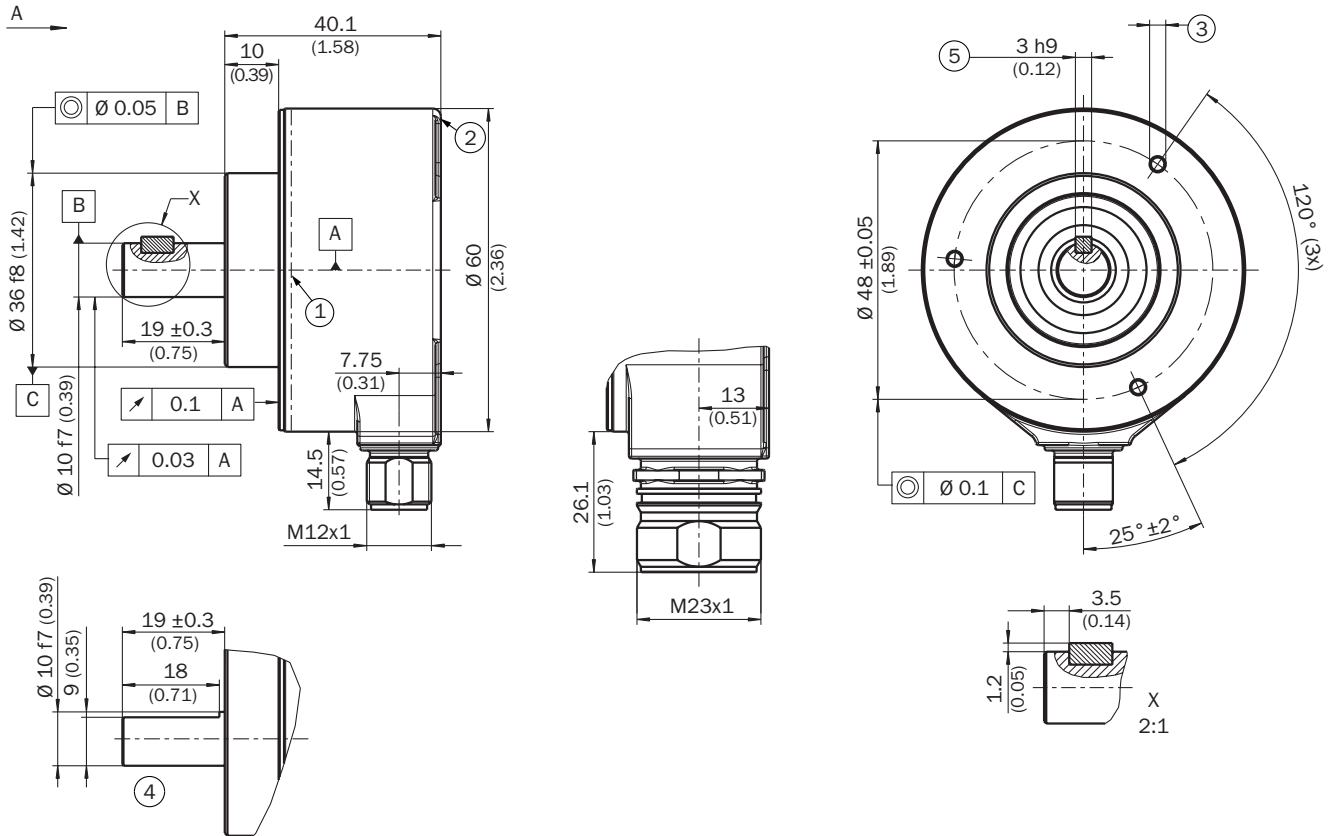

General tolerances according to DIN ISO 2768-mk

- ① Operating temperature measuring point (freely selectable, around the housing surface area in each case, approx. 3 mm away from flange)
- ② Measuring point vibration (respectively at the housing face. approx. 3 mm away from the cover edge)
- ③ M3 / M4 (3x) (6 mm deep)
- ④ Shaft with flat
- ⑤ Square key, DIN 6885-A 3x3x6

PIN assignment

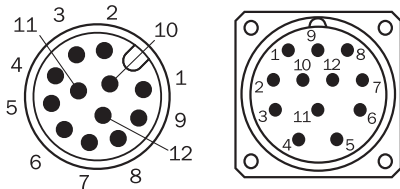

View of M23 and M12 male device connector on encoder

PIN (M23)	PIN (M12)	Wire colors (cable connection)	Signal	Explanation
1	5	Red	U <sub>S</sub>	Operating voltage
2	12	Blue	GND	Ground connection
3	11	Yellow	Clock +	Interface signals
4	2	White	Data +	Interface signals
5	10	Orange	SET	Electronic adjustment

PIN (M23)	PIN (M12)	Wire colors (cable connection)	Signal	Explanation
6	3	Brown	Data -	Interface signals
7	4	Violet	Clock -	Interface signals
8	9	Black	- SIN	Signal cable
9	1	Orange-black	CW/CCW (V/R)	Sequence in direction of rotation
10	7	Green	- COS	Signal cable
11	6	Gray	+ COS	Signal cable
12	8	Pink	+ SIN	Signal cable
			Screen	Screen connected to housing on encoder side. Connected to ground on control side.

### Diagrams

Signal SIN/COS before differential generation

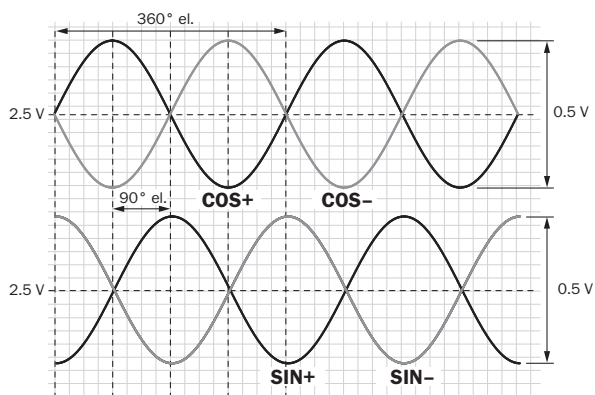

For clockwise shaft rotation, looking in direction "A" (see dimensional drawing)

Signal	Interface signals	Signal before differential generation At load 120 Ω	Signal offset
+ SIN - SIN + COS - COS	Analog, differential	0,5 V <sub>SS</sub> ± 20 %	2,5 V ± 10 %

Signal SIN/COS after differential generation

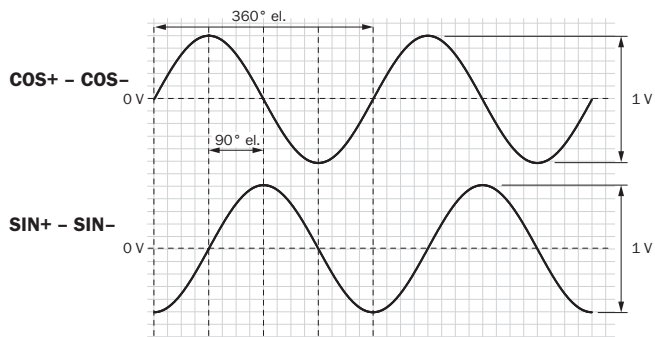



For clockwise shaft rotation, looking in direction "A" (see dimensional drawing)

Supply voltage	Output
4,5 V ... 5,5 V	Sin/Cos 1.0 V <sub>pp</sub>

### Recommended accessories

Other models and accessories → [www.sick.com/AFS\\_AFM60S\\_Pro](http://www.sick.com/AFS_AFM60S_Pro)

	Brief description	Type	Part no.
Programming and configuration tools			
	USB programming unit, for programmable SICK encoders AFS60, AFM60, DFS60, VFS60, DFV60 and wire draw encoders with programmable encoders	PGT-08-S	1036616
Plug connectors and cables			
	Head A: female connector, M12, 12-pin, straight Head B: male connector, D-Sub, 9-pin, straight Cable: SSI + incremental, SSI + Sin/Cos, Incremental, shielded, 0.5 m Programming adapter cable for programming tool PGT-10-Pro and PGT-08-S	DSL-2D12-G0M5AC4	2088790

## SICK AT A GLANCE

SICK is one of the leading manufacturers of intelligent sensors and sensor solutions for industrial applications. A unique range of products and services creates the perfect basis for controlling processes securely and efficiently, protecting individuals from accidents and preventing damage to the environment.

We have extensive experience in a wide range of industries and understand their processes and requirements. With intelligent sensors, we can deliver exactly what our customers need. In application centers in Europe, Asia and North America, system solutions are tested and optimized in accordance with customer specifications. All this makes us a reliable supplier and development partner.

Comprehensive services complete our offering: SICK LifeTime Services provide support throughout the machine life cycle and ensure safety and productivity.

For us, that is “Sensor Intelligence.”

## WORLDWIDE PRESENCE:

Contacts and other locations –[www.sick.com](http://www.sick.com)