

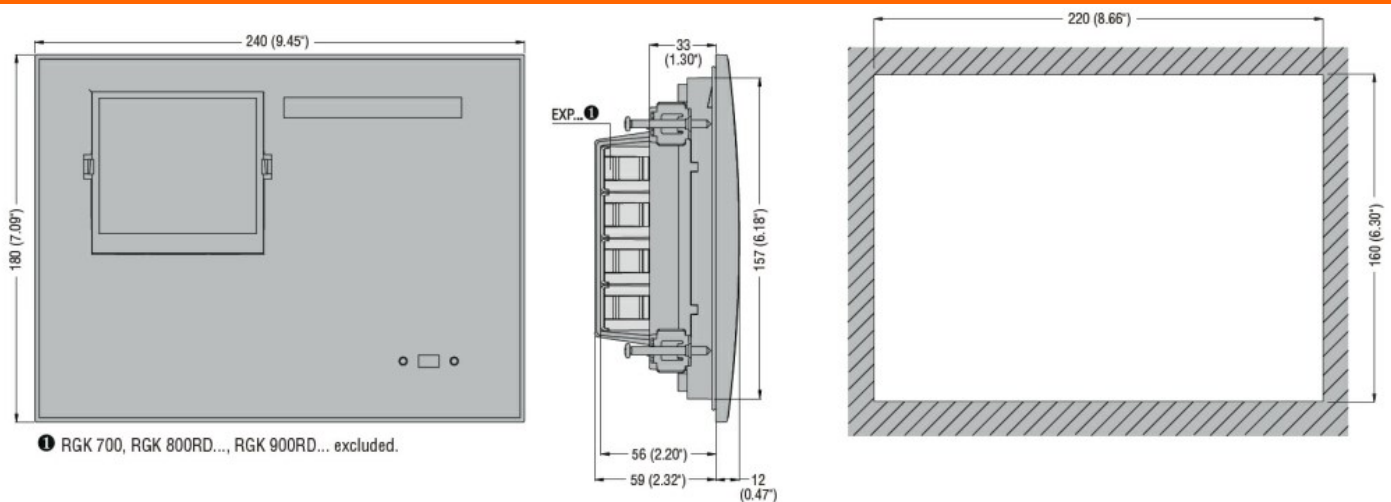

Product designation	Remote units		
Product type designation	RGK900RDSA		
Power supply			
Rated battery voltage	V	12/24VDC	
Digital inputs			
Digital input type	3 neg.+ 1 pos.		
Static Outputs			
Static output type	2		
Interface			
CANbus	Yes		
Mechanical features			
Conductor cross section			
	min	mm ²	0.2
	Max	mm ²	2.5
	min	AWG	24 or 18 UL/CSA
	Max	AWG	12
Tightening torque (Max)			
		Nm	0.56
		lbin	4.5
Ambient conditions			
Protection degree	IP65		
Dimensions			

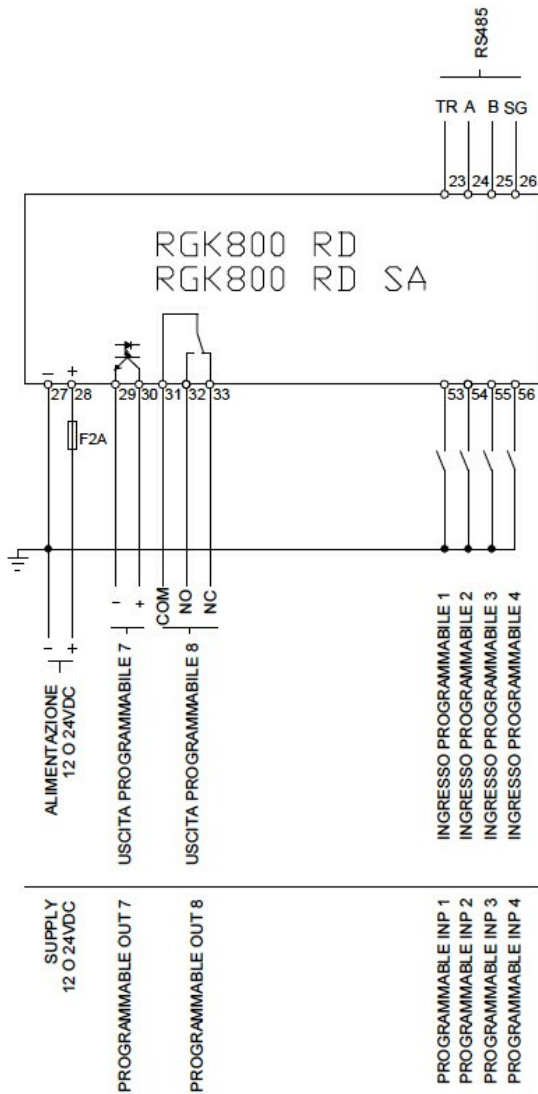

Wiring diagrams



Certifications and compliance

Compliance

CSA C22.2 n° 14

IEC 61000-6-3

IEC/EN 61000-6-2

IEC/EN 61010-1

UL508

Certificates

EAC

UL Listed for USA and Canada (cULus-File E93601)

ETIM classification

ETIM 8.0

EC002498 -
Accessories/spare
parts for low-
voltage switch
technology