

OLÉRON RÉSIDENTIELS

### OLÉRON

OLÉRON RÉSIDENTIEL  
POLYCARBONATE - VERRE DÉPOLI

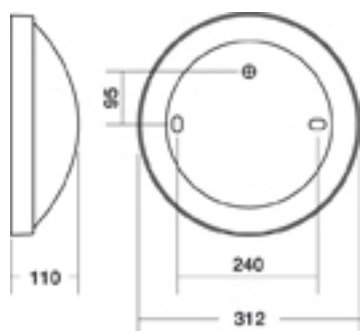

Référence du produit : 527270









Classe : 

#### ÉLÉMENTS NORMATIFS

IP21 IK04 CLASSE II 850 °C/30 sec.     
NF EN 60695-2-1

#### SOURCE

► Sources fluorescentes

|  |   |
|--|---|
|  E27<br>70W-20W |  2G7<br>2x9W   |
|  E27<br>15W     |  G24q2<br>18W  |
|  G24q2<br>2x18W |  G24q3<br>26W  |
|  G24Q3<br>2x26W |  GX24q3<br>32W |

#### COULEUR

 Blanc

#### AIDE AUX DESCRIPTIFS

Livré sans lampe

#### CARACTÉRISTIQUES TECHNIQUES

Hublot rond Ø 312 mm. Classe II. IP 21, IK04. Douille E27 en porcelaine Maxi : 70W halogène, 20W CFLI. Jupe en Polycarbonate fermeture par système 'quart de tour'. Diffuseur en verre émaillé intérieur et dépoli extérieur. Livré sans lampe.

#### FACILITÉ DE POSE ET DE MAINTENANCE

Oléron simplifie mise en oeuvre et entretien : réglage de niveau, diffuseur maintenu par clips, réserve de câble.

Joindre Sarlam

Par mail : [service-commercial.sarlam@sarlam.com](mailto:service-commercial.sarlam@sarlam.com)

Par tél : 02 37 53 80 00