



Motor protection
circuit breaker
SM1R

Product designation

Product type designation

Electrical features

Number of poles	Nr.	3
Magnetic protection		yes
Thermal protection		yes
Phase failure detection		yes
Rated insulation voltage U_i IEC/EN	V	690
Rated impulse withstand voltage U_{imp}	kV	6
Rated frequency	Hz	50/60
Thermal trip adjustment range		13...18
Rated current (I_n)	A	18
Magnetic tripping		13 x I_n
Power dissipation per pole	min	W 1.34
	max	W 2.57

Operational short-circuit current breaking capacity (I_{cs}) at AC

230V	kA	100
400V	kA	100
440V	kA	5
500V	kA	5
690V	kA	2

Maximum short-circuit current breaking capacity (I_{cu}) at AC

230V	kA	100
400V	kA	100
440V	kA	10
500V	kA	10
690V	kA	4

Tripping class

10A

IEC Utilization category

A

Operations

Mechanical life	cycles	100000
Electrical life	cycles	100000

Mechanical features

Tightening torque for terminals

min	Nm	2.5
max	Nm	3
min	lbin	22
max	lbin	26.5

Max number of wires simultaneously connectable

Nr. 2

Conductor section

AWG/Kcmil

min	16
max	8

Flexible w/o lug conductor section	min	mm ²	1
	max	mm ²	10
Flexible c/w lug conductor section	min	mm ²	1
	max	mm ²	10
Flexible with insulated spade lug conductor section	min	mm ²	1
	max	mm ²	10
Screwdriver			PH2
Power terminal protection according to IEC/EN 60529			IP20 on front
Cable stripping length	main circuit	mm	12
Ambient conditions			
Temperature			
Operating temperature	min	°C	-20
	max	°C	+60
Storage temperature	min	°C	-50
	max	°C	+80
Compensation temperature	min	°C	-20
	max	°C	+50
Max altitude		m	3000
Operating position	normal allowable		Vertical plan Any
Fixing			Screw / DIN rail 35mm
Weight		g	390
UL technical data			
Motor Disconnect	at 480V	kA	30
	at 600V	kA	30
	protection		200A class J
Group Motor Installation	at 480V	kA	30
	at 600V	kA	30
	protection		200A class J
Maximum UL/CSA horsepower ratings single-phase	110V-120V	HP	1
	220V-240V	HP	3
Maximum UL/CSA horsepower ratings three-phase, 3-pole	200V-208V	HP	5
	220V-240V	HP	5
	440V-480V	HP	10
	550V-600V	HP	15
Dimensions			

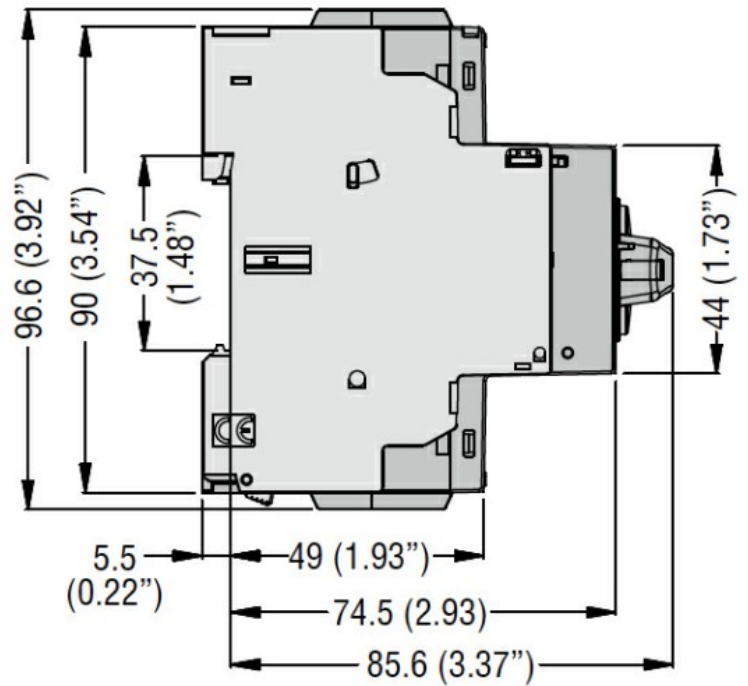
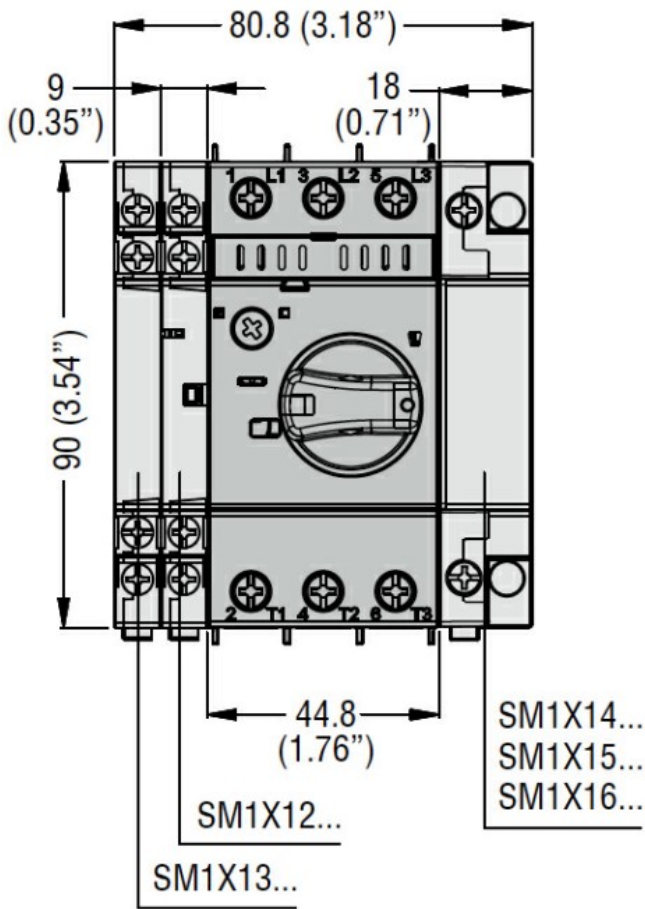

Wiring diagrams

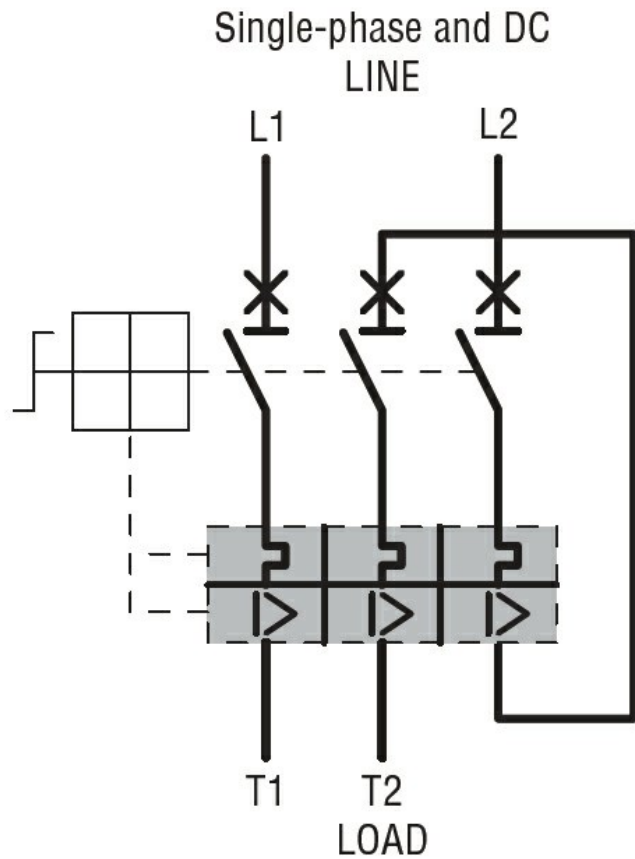
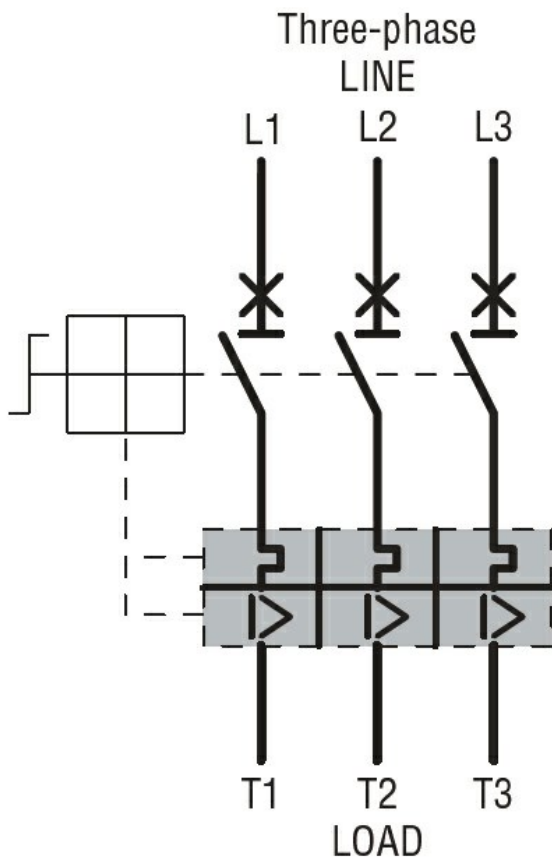

Certifications and compliance

Certifications

CSA C22.2 n° 14

IEC/EN 60947-1

IEC/EN 60947-2

IEC/EN 60947-4-1

UL508

Compliance

cULus

EAC

ETIM classification

ETIM 8.0

EC000074 -
Motor protection
circuit-breaker