



WSE26P-24165100A00

W26

COMPACT PHOTOELECTRIC SENSORS

SICK
Sensor Intelligence.



Illustration may differ

Ordering information

| Type | Part no. |
|--------------------|----------|
| WSE26P-24165100A00 | 1118267 |

Other models and accessories → www.sick.com/W26



Detailed technical data

Features

| | |
|---|---|
| Functional principle | Through-beam photoelectric sensor |
| Sensing range | |
| Sensing range min. | 0 m |
| Sensing range max. | 60 m |
| Maximum distance range from receiver to sender (operating reserve 1) | 0 m ... 60 m |
| Recommended distance range from receiver to sender (operating reserve 2) | 0 m ... 50 m |
| Recommended sensing range for the best performance | 0 m ... 50 m |
| Emitted beam | |
| Light source | PinPoint LED |
| Type of light | Visible red light |
| Shape of light spot | Point-shaped |
| Light spot size (distance) | Ø 115 mm (15 m) |
| Maximum dispersion of the emitted beam around the standardized transmission axis (squint angle) | < +/- 1.0° (at Ta = +23 °C) |
| Key LED figures | |
| Normative reference | EN 62471:2008-09 IEC 62471:2006, modified |
| LED risk group marking | Free group |
| Wave length | 635 nm |

| | | |
|----------------------|------------------------------------|--|
| Average service life | 100,000 h at $T_a = +25\text{ °C}$ | |
| Adjustment | IO-Link | For configuring the sensor parameters and Smart Task functions |
| | Wire/pin | For activating the test input |
| Indication | LED blue | BluePilot: Alignment aid |
| | LED green | Operating indicator Static on: power on Flashing: IO-Link mode |
| | LED yellow | Status of received light beam Static on: object not present Static off: object present Flashing: Below the 1.5 function reserve |
| | | |

Safety-related parameters

| | |
|-------------------------------------|--|
| MTTF_D | 524 years |
| DC_{avg} | 0% |
| T_M (mission time) | 20 years (EN ISO 13849, rate of use: 60 %) |

Communication interface

| | |
|-----------------------------|--|
| IO-Link | ✓, V1.1 |
| Data transmission rate | COM2 (38,4 kBaud) |
| Cycle time | 2.3 ms |
| Process data length | 16 Bit |
| Process data structure | Bit 0 = switching signal Q_{L1} Bit 1 = switching signal Q_{L2} Bit 2 ... 15 = empty |
| VendorID | 26 |
| DeviceID HEX | 0x800188 |
| DeviceID DEC | 8389000 |
| Compatible master port type | A |
| SIO mode support | Yes |

Electrical data

| | | |
|--|---|--------------------|
| Supply voltage U_B | 10 V DC ... 30 V DC ¹⁾ | |
| Ripple | $\leq 5\text{ V}_{pp}$ | |
| Usage category | DC-12 (According to EN 60947-5-2) DC-13 (According to EN 60947-5-2) | |
| Current consumption, sender | $\leq 30\text{ mA}$, $< 50\text{ mA}$, without load. At $U_B = 24\text{ V}$ | |
| Current consumption, receiver | $\leq 30\text{ mA}$, $< 50\text{ mA}$, without load. At $U_B = 24\text{ V}$ | |
| Protection class | III | |
| Digital output | Number | 2 (Complementary) |
| | Type | Push-pull: PNP/NPN |

¹⁾ Limit values.

²⁾ Signal transit time with resistive load in switching mode.

³⁾ With light/dark ratio 1:1.

⁴⁾ This switching output must not be connected to another output.

| | |
|---------------------------------------|--|
| Signal voltage PNP HIGH/LOW | Approx. $U_B - 2.5 \text{ V} / 0 \text{ V}$ |
| Signal voltage NPN HIGH/LOW | Approx. $U_B / < 2.5 \text{ V}$ |
| Output current I_{max} | $\leq 100 \text{ mA}$ |
| Circuit protection outputs | Reverse polarity protected Overcurrent and short-circuit protected |
| Response time | $\leq 500 \mu\text{s}$ ²⁾ |
| Repeatability (response time) | 150 μs |
| Switching frequency | 1,000 Hz ³⁾ |
| Pin/Wire assignment, sender | |
| Function of pin 4/black (BK) | Test at 0 V |
| Pin/Wire assignment, receiver | |
| Function of pin 4/black (BK) | Digital output, light switching, object present → output Q_{L1} LOW; IO-Link communication C ⁴⁾ |
| Function of pin 4/black (BK) – detail | The pin 4 function of the sensor can be configured, Additional possible settings via IO-Link |
| Function of pin 2/white (WH) | Digital output, alarm → output HIGH |
| Function of pin 2/white (WH) – detail | The pin 2 function of the sensor can be configured, Additional possible settings via IO-Link |

¹⁾ Limit values.

²⁾ Signal transit time with resistive load in switching mode.

³⁾ With light/dark ratio 1:1.

⁴⁾ This switching output must not be connected to another output.

Mechanical data

| | |
|---|-----------------------------|
| Housing | Rectangular |
| Dimensions (W x H x D) | 24.6 mm x 82.5 mm x 53.3 mm |
| Connection | Male connector M12, 4-pin |
| Material | |
| Housing | Plastic, VISTAL® |
| Front screen | Plastic, PMMA |
| Male connector | Plastic, VISTAL® |
| Weight | Approx. 160 g |
| Maximum tightening torque of the fixing screws | 1.3 Nm |

Ambient data

| | |
|--------------------------------------|--|
| Enclosure rating | IP66 (EN 60529) IP67 (EN 60529) IP69 (EN 60529) ¹⁾ |
| Ambient operating temperature | -40 °C ... +60 °C |
| Ambient temperature, storage | -40 °C ... +75 °C |
| Shock resistance | 50 g, 11 ms (25 positive and 25 negative shocks per axis, for X, Y, Z axes, 150 shocks in total (EN60068-2-27)) 50 g, 6 ms (5,000 positive and 5,000 negative shocks per axis, for X, Y, Z axes, 30,000 shocks in total (EN60068-2-27)) |
| Vibration resistance | 10 Hz ... 2,000 Hz (Amplitude 0.5 mm / 10 g, 20 sweeps per axis, for X, Y, Z axes, 1 octave/min, (EN60068-2-6)) |
| Air humidity | 35 % ... 95 %, Relative humidity (no condensation) |

¹⁾ Replaces IP69K with ISO 20653: 2013-03.

| | |
|--|------------------------------|
| Electromagnetic compatibility (EMC) | EN 60947-5-2 |
| Resistance to cleaning agent | ECOLAB |
| UL File No. | NRKH.E181493 & NRKH7.E181493 |

¹⁾ Replaces IP69K with ISO 20653: 2013-03.

Smart Task

| | |
|----------------------------------|--|
| Smart Task name | Base logics |
| Logic function | Direct AND OR Window Hysteresis |
| Timer function | Deactivated On delay Off delay ON and OFF delay Impulse (one shot) |
| Inverter | Yes |
| Switching frequency | SIO Logic: 800 Hz ¹⁾ IOL: 650 Hz ²⁾ |
| Response time | SIO Logic: 600 μs ¹⁾ IOL: 750 μs ²⁾ |
| Repeatability | SIO Logic: 300 μs ¹⁾ IOL: 400 μs ²⁾ |
| Switching signal | |
| Switching signal Q _{L1} | Switching output |

¹⁾ Use of Smart Task functions without IO-Link communication (SIO mode).

²⁾ Use of Smart Task functions with IO-Link communication function.

Diagnosis

| | |
|-------------------------|----------------------------|
| Device status | Yes |
| Quality of teach | Yes |
| Quality of run | Yes, Contamination display |

Classifications

| | |
|---------------------|----------|
| ECLASS 5.0 | 27270901 |
| ECLASS 5.1.4 | 27270901 |
| ECLASS 6.0 | 27270901 |
| ECLASS 6.2 | 27270901 |
| ECLASS 7.0 | 27270901 |
| ECLASS 8.0 | 27270901 |
| ECLASS 8.1 | 27270901 |
| ECLASS 9.0 | 27270901 |
| ECLASS 10.0 | 27270901 |
| ECLASS 11.0 | 27270901 |
| ECLASS 12.0 | 27270901 |
| ETIM 5.0 | EC002716 |

| | |
|-----------------------|----------|
| ETIM 6.0 | EC002716 |
| ETIM 7.0 | EC002716 |
| ETIM 8.0 | EC002716 |
| UNSPSC 16.0901 | 39121528 |

Dimensional drawing (Dimensions in mm (inch))

Dimensional drawing, sensor

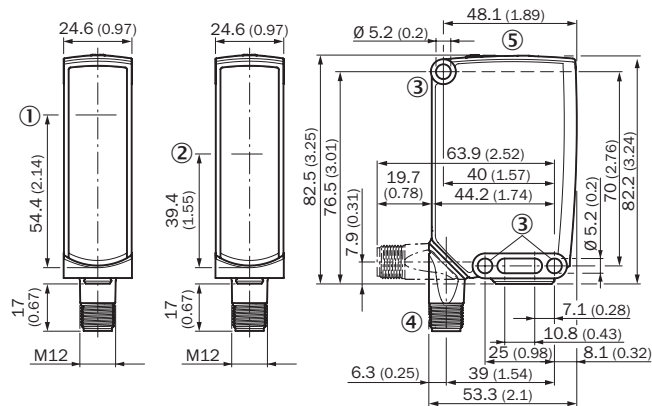

- ① Center of optical axis, sender
- ② Center of optical axis, receiver
- ③ Mounting hole, \varnothing 5.2 mm
- ④ Connection
- ⑤ Display and adjustment elements

Adjustments

Display and adjustment elements

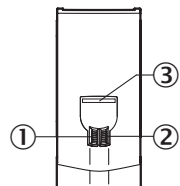

- ① LED indicator green
- ② LED indicator yellow
- ③ LED blue

Connection type

Pin assignment

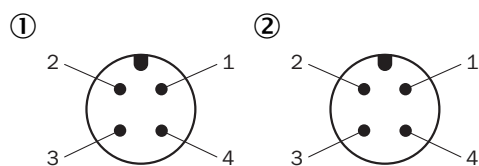

M12 male connector, 4-pin, A-coding

- ① Receiver
- ② Sender

Connection diagram

Cd-392

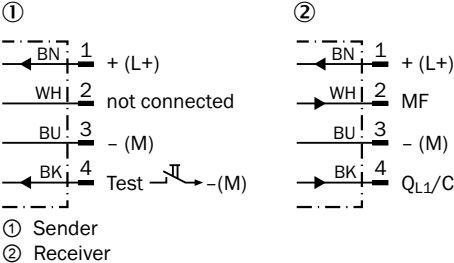

Truth table

Push-pull: PNP/NPN - dark switching \bar{Q}

| | Dark switching \bar{Q} (normally open (upper switch), normally closed (lower switch)) | |
|-------------------------|---|------------------------------|
| | Object not present → Output LOW | Object present → Output HIGH |
| Light receive | ✓ | ✗ |
| Light receive indicator | ☉ | ✗ |
| Load resistance to L+ | ⚠ | ✗ |
| Load resistance to M | ✗ | ⚠ |
| | | |

Push-pull: PNP/NPN - light switching Q

| | Light switching Q (normally closed (upper switch), normally open (lower switch)) | |
|-------------------------|--|-----------------------------|
| | Object not present → Output HIGH | Object present → Output LOW |
| Light receive | ✓ | ✗ |
| Light receive indicator | ☉ | ✗ |
| Load resistance to L+ | ✗ | ⚠ |
| Load resistance to M | ⚠ | ✗ |
| | | |

Characteristic curve

WSE26P-xxxxx1xx

Operating reserve

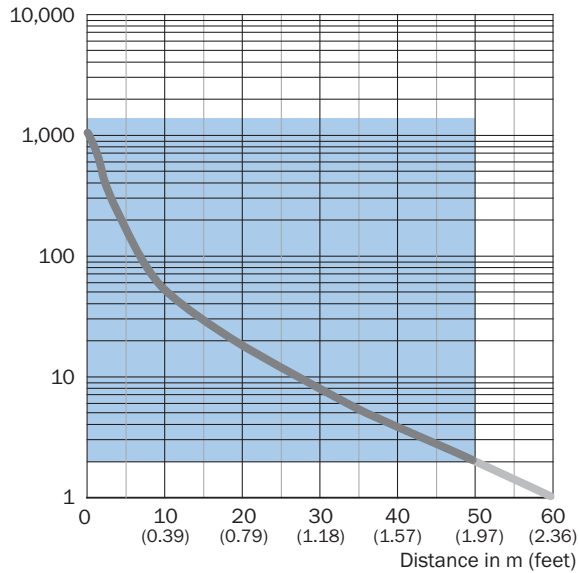

Recommended sensing range for the best performance

WSE26I-xxxxx1xx

Light spot size

Visible red light

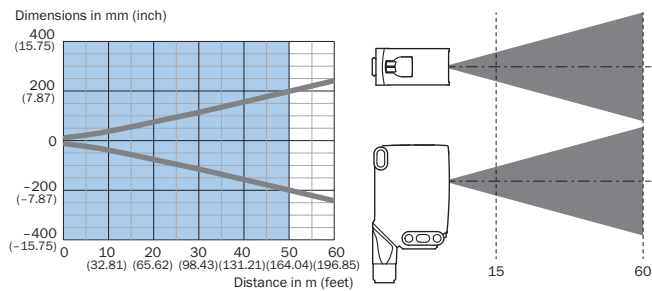

Recommended sensing range for the best performance

WSE26P-xxxxx1xx

Sensing range diagram

WSE26P-xxxxx1xx

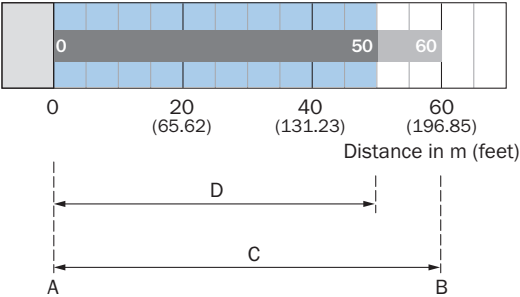

 Recommended sensing range for the best performance

WSE26I-xxxxx1xx

| | |
|---|--|
| | |
| A | Sensing range min. in m |
| B | Sensing range max. in m |
| C | Maximum distance range from receiver to sender |
| D | Recommended distance range from receiver to sender |

Functions

Operation note

BluePilot: Blue indicator LEDs with double benefits

| | |
|---|---|
| <p>Easy and quick sensor alignment with the help of the LED indicator</p> <p>All blue LEDs illuminate</p> <ul style="list-style-type: none"> - optimum alignment - highest possible operating reserve | <p>WSE through-beam photoelectric sensor alignment</p> |
| <p>Service note</p> <p>A reduction in sensor availability is displayed by a decrease of the blue LEDs.</p> <p>Possible causes:</p> <ul style="list-style-type: none"> a) insufficient alignment b) contamination of the optical surfaces c) particles in the light beam | |

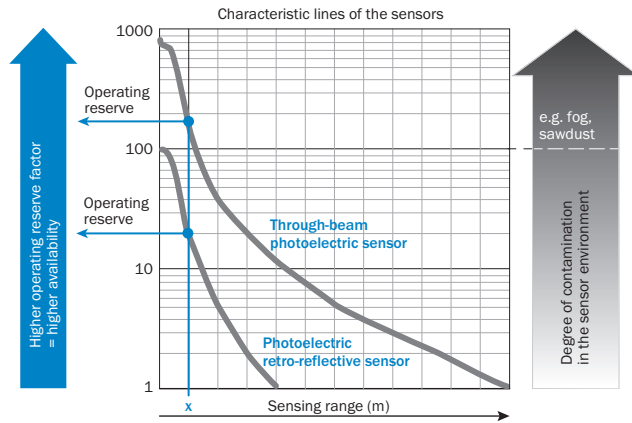

Operation note



At a sensing range of „x“ the photoelectric retro-reflective and through-beam photoelectric sensors have different operating reserves (see blue arrow). The higher the operating reserve factor, the better the sensor can compensate the contamination in the air or in the light beam and on the optical surfaces (front screen, reflector), i.e. the sensor has the maximum availability, otherwise the sensor switches due to pollution although there is no object in the path of the light beam.

Recommended accessories

Other models and accessories → www.sick.com/W26

| | Brief description | Type | Part no. |
|---|---|--------------------|----------|
| Universal bar clamp systems | | | |
|  | Plate N12 for universal clamp. For mounting PL30A, P250 reflectors, W27 and WTR2 sensors., Zinc plated steel (sheet), Zinc die cast (clamping bracket), Universal clamp (2022726), mounting hardware | BEF-KHS-N12 | 2071950 |
| Plug connectors and cables | | | |
|  | <ul style="list-style-type: none"> • Connection type head A: Female connector, M12, 4-pin, straight, A-coded • Connection type head B: Flying leads • Signal type: Sensor/actuator cable • Cable: 5 m, 4-wire, PVC • Description: Sensor/actuator cable, unshielded • Application: Zones with chemicals | YF2A14-050VB3XLEAX | 2096235 |
|  | <ul style="list-style-type: none"> • Connection type head A: Male connector, M12, 4-pin, straight • Description: Unshielded • Connection systems: Screw-type terminals • Permitted cross-section: ≤ 0.75 mm² | STE-1204-G | 6009932 |

SICK AT A GLANCE

SICK is one of the leading manufacturers of intelligent sensors and sensor solutions for industrial applications. A unique range of products and services creates the perfect basis for controlling processes securely and efficiently, protecting individuals from accidents and preventing damage to the environment.

We have extensive experience in a wide range of industries and understand their processes and requirements. With intelligent sensors, we can deliver exactly what our customers need. In application centers in Europe, Asia and North America, system solutions are tested and optimized in accordance with customer specifications. All this makes us a reliable supplier and development partner.

Comprehensive services complete our offering: SICK LifeTime Services provide support throughout the machine life cycle and ensure safety and productivity.

For us, that is “Sensor Intelligence.”

WORLDWIDE PRESENCE:

Contacts and other locations –www.sick.com