

Part number

C30FA 16



Female crimp contact, C30 series, 300 A, turned silver plated, wire cross section 16 mm², AWG 6

Product description		Material properties	
Product type	Crimp contact	Main material	Copper alloy
Series	C30		Compliant with exemption 6(c): copper alloy containing up to 4% lead by weight
Gender	Female	RoHs conformity	
Technical data		China RoHs - EFUP	50
Current	300 A	REACH SVHC substances	Yes Lead
Wire cross-section	16,00 mm ²	General ordering information	
AWG size	6	EAN13 code	8015747291002
Contact type	Turned silver plated	Packaging Information	
Further technical details		Packaging length	112,00 mm
Contact resistance	≤ 0,2 mΩ	Packaging height	95,00 mm
Weight	24,50 g	Packaging width	117,00 mm
Conductors stripping length	19 mm	Packaging volume	1,24 dm ³
		Packaging description	Carton box
		Packaging quantity	40 Pcs
		Packaging EAN code	8015747291019
		Sub-packaging description	Plastic box
		Sub-packaging quantity	5 Pcs
		Sub-packaging EAN barcode	8015747291026

Part number

C30FA 16



Catalogue drawings

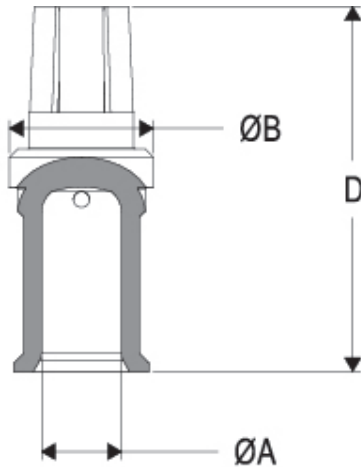

C30FA contacts

conductor section (mm ²)	conductor slot \varnothing A (mm)	\varnothing B (mm)	D (mm)	conductor stripping length (mm)
16	5,5	18	39,1	19
25	7	18	39,1	19
35	8,2	18	40,1	20
50	10	18	45,6	22,5
70	11,5	18	45,6	22,5
95	13,5	21	45,6	22,5
120	15,5	21	45,6	22,5

Notes

California Proposition 65 Information



WARNING

This product can expose you to lead and its compounds, known to the State of California to cause cancer and/or reproductive toxicity. For more information go to www.P65Warnings.ca.gov.