



| | |
|--------------------------|---|
| Product designation | Selector switch actuator key - 3 position |
| Product type designation | LPCS38 |

General characteristics

| | |
|--------------------------|----------------------|
| Colour | Black |
| Type of positions | Selector switch |
| Material | Polyamide |
| IEC degree of protection | IP66, IP67 and IP69K |

Mechanical features

| | | |
|------------------|--------|----------|
| Mechanical life | cycles | 1000000 |
| Mounting adapter | | LPXAU120 |
| Weight | g | 60 |

UL technical data

| | |
|-------------------------|------------------------------|
| UL degree of protection | Type1, 2, 3R, 4, 4X, 12, 12K |
|-------------------------|------------------------------|

Ambient conditions

| | | | | |
|-------------|-----------------------|-----|----|-----|
| Temperature | | | | |
| | Operating temperature | min | °C | -25 |
| | | max | °C | +70 |
| | Storage temperature | min | °C | -40 |
| | | max | °C | +85 |

Dimensions

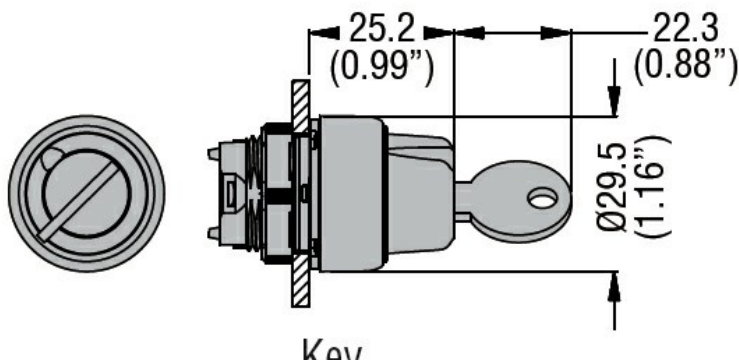

Certifications and compliance

| | |
|--------------|---------------------|
| Compliance | CSA C22.2 n° 14 |
| | IEC/EN/BS 60947-1 |
| | IEC/EN/BS 60947-5-1 |
| | UL508 |
| Certificates | CCC |
| | cULus |

ETIM classification

ETIM 8.0

EC000222 -
Front element for
selector switch