



MPS-025CLTU0

MPS-C

POSITION SENSORS

SICK
Sensor Intelligence.



Ordering information

Type	Part no.
MPS-025CLTU0	1079359

Other models and accessories → www.sick.com/MPS-C



Detailed technical data

Features

Cylinder type	C-slot
Cylinder types with adapter	Round body cylinder Profile cylinders and tie-rod cylinders SMC rail CDQ2 SMC rail ECDQ2
Measuring range	25 mm ¹⁾
Housing length	41 mm
Switching output	Push-pull: PNP/NPN
Output function	Analog, IO-Link, Switching output
Electrical wiring	DC 4-wire
Analog output (voltage)	0 V ... 10 V
Analog output (current)	4 mA ... 20 mA
Enclosure rating	IP67 ²⁾
Adjustment	
Teach-in control panel	Teaching in analog outputs Selecting the current/voltage output Inverting the analog output Teaching in digital switching outputs
IO-Link	Teaching in 4 switching points Pin 2 configuration (0 V–10 V, 4 mA–20 mA) Measuring range (mm) teach-in (analog output) Disabling teach-in pushbutton Teach-in modes per output via IO-Link (cylinder switch mode, two point mode, window mode, and single point mode)

¹⁾ ± 1 mm.

²⁾ According to EN 60529.

Mechanics/electronics

Supply voltage	12 V DC ... 30 V DC
Power consumption	42 mA, without load
Voltage drop	≤ 2 V
Continuous current I_a	≤ 100 mA ¹⁾
Max. load resistance	≤ 500 Ω Power Output, at 24 V
Min. load resistance	≥ 2 kΩ ²⁾
Protection class	III
Time delay before availability	0.15 s
Required magnetic field sensitivity, typ.	3 mT ... 12 mT
Resolution, typ.	≥ 50 μm
Linearity error, typ.	0.3 mm ³⁾
Repeat accuracy, typ.	0.1 mm ⁴⁾
Sampling rate, typ.	1 ms
Reverse polarity protection	Yes
Short-circuit protection	Yes
Status indicator LED	Yes
Digital switching output	Yes
Teach-in	Yes
Ambient operating temperature	-20 °C ... +70 °C
Shock and vibration resistance	30 g, 11 ms / 10 ... 55 Hz, 1 mm
EMC	According to EN 60947-5-7 ⁵⁾
Connection type	Cable, 4-wire, 2 m
Connection type Detail	
Deep-freeze property	Do not bend below 0 °C
Conductor cross section	0.08 mm ²
Cable diameter	Ø 2.6 mm
Bending radius	With fixed installation > 5 x cable diameter For flexible use > 10 x cable diameter
Cable outlet	Axial
Material	
Housing	Plastic
Cable	PUR
UL File No.	NRKH.E181493 & NRKH7.E181493

¹⁾ ≤ 100 mA (PUSH); ≥ -100 mA (PULL).

²⁾ Voltage output.

³⁾ At 25 °C, linearity error (maximum deviation) depending on response curve and minimal deviation function.

⁴⁾ At 25 °C, repeatability magnet movement in one direction.

⁵⁾ The analog measured value can deviate under transient conditions.

Safety-related parameters

MTTF_D	244 years
DC_{avg}	0 %

T_M (mission time)	20 years
-------------------------------------	----------

Communication interface

Communication interface	IO-Link V1.1
Communication Interface detail	COM3
Cycle time	1 ms
Process data length	16 Bit
Process data structure	Bit 0 = switching signal Q _{L1} Bit 1 = switching signal Q _{L2} Bit 2 = switching signal Q _{L3} Bit 3 = switching signal Q _{L4} Bit 4 ... 15 = position (in 50 µm)

Classifications

ECLASS 5.0	27270104
ECLASS 5.1.4	27270104
ECLASS 6.0	27270104
ECLASS 6.2	27270104
ECLASS 7.0	27270104
ECLASS 8.0	27270104
ECLASS 8.1	27270104
ECLASS 9.0	27270104
ECLASS 10.0	27270104
ECLASS 11.0	27270104
ECLASS 12.0	27274301
ETIM 5.0	EC002544
ETIM 6.0	EC002544
ETIM 7.0	EC002544
ETIM 8.0	EC002544
UNSPSC 16.0901	39122230

Installation note

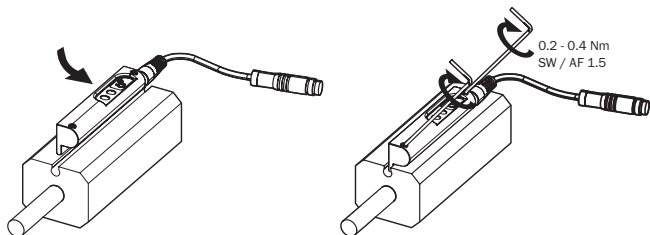

Connection diagram

Cd-358

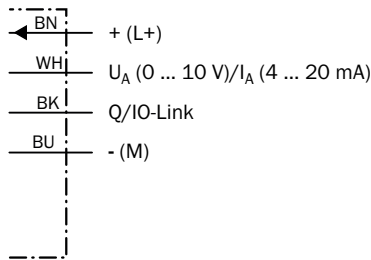

Dimensional drawing (Dimensions in mm (inch))

Cable

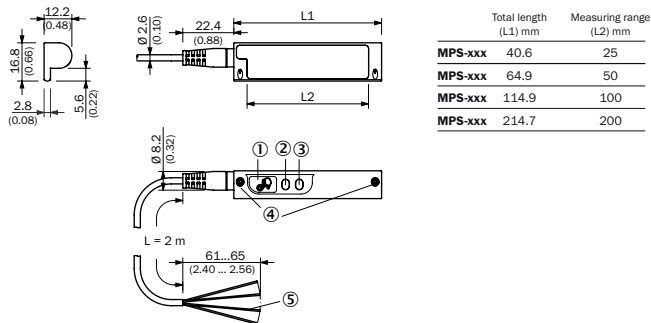



- ① Teach-in button
- ② Status LEDs
- ③ Operating LEDs
- ④ Fixing screw SW 1.5
- ⑤ Connection

Recommended accessories

Other models and accessories → www.sick.com/MPS-C

	Brief description	Type	Part no.
Connection modules			
	IO-Link V1.1 Class A port, USB2.0 port, optional external power supply 24V / 1A	IOLA2US-01101 (SiLink2 Master)	1061790
	EtherCAT IO-Link Master, IO-Link V1.1, Port Class A, power supply via 7/8" cable 24 V / 8 A, fieldbus connection via M12 cable	IOLG2EC-03208R01 (IO-Link Master)	6053254
	EtherNet/IP IO-Link Master, IO-Link V1.1, Port Class A, power supply via 7/8" cable 24 V / 8 A, fieldbus connection via M12-cable	IOLG2EI-03208R01 (IO-Link Master)	6053255
	PROFINET IO-Link Master, IO-Link V1.1, Port Class A, power supply via 7/8" cable 24 V / 8 A, fieldbus connection via M12 cable	IOLG2PN-03208R01 (IO-Link Master)	6053253

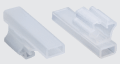
	Brief description	Type	Part no.
Brackets for cylinder sensors			
	Mounting bracket for integrated profile cylinder/tie-rod cylinder, zinc diecast, mounting hardware included	BEF-KHZ-PC1	2076170
	1 piece, Mounting bracket on round body cylinder with piston diameter of 1 mm ... 130 mm, ambient temperature min -30 °C max 80 °C, stainless steel, Aluminum	BEF-KHZ-RC1-130	2077686
	1 piece, Mounting bracket on round body cylinder with piston diameter of 1 mm ... 25 mm, ambient temperature min -30 °C max 80 °C, stainless steel, Aluminum	BEF-KHZ-RC1-25	2077685
Other mounting accessories			
	10 pieces, Label Holder, 2.5 mm to 3.5 mm, 10 pcs., TPU	LABEL HOLDER	2086019

Recommended services

Additional services → www.sick.com/MPS-C

	Type	Part no.
Function Block Factory		
<ul style="list-style-type: none"> • Description: The Function Block Factory supports common programmable logic controllers (PLCs) from various manufacturers, such as Siemens, Beckhoff, Rockwell Automation and B&R. More information on the FBF can be found <a _blank"="" href="https://fbf.cloud.sick.com target=">here. • Note: You can configure your function block at <a _blank"="" href="https://fbf.cloud.sick.com target=">Function Block Factory. As a login please use your SICK ID. 	Function Block Factory	On request

SICK AT A GLANCE

SICK is one of the leading manufacturers of intelligent sensors and sensor solutions for industrial applications. A unique range of products and services creates the perfect basis for controlling processes securely and efficiently, protecting individuals from accidents and preventing damage to the environment.

We have extensive experience in a wide range of industries and understand their processes and requirements. With intelligent sensors, we can deliver exactly what our customers need. In application centers in Europe, Asia and North America, system solutions are tested and optimized in accordance with customer specifications. All this makes us a reliable supplier and development partner.

Comprehensive services complete our offering: SICK LifeTime Services provide support throughout the machine life cycle and ensure safety and productivity.

For us, that is “Sensor Intelligence.”

WORLDWIDE PRESENCE:

Contacts and other locations –www.sick.com