

Gainable compact

RAS-M24U2DVG-E

Données



Unité intérieure		
Puissance froid nominale	kW	7,10
Puissance chaud nominale	kW	8,10
Débit d'air (GV/PV)	m3/h	1060/760
Niveau de pression sonore à 1,5m (GV/PV)	dB(A)	39/33
Niveau de puissance sonore (GV/PV)	dB(A)	54/48
Débit d'air (GV/PV)	m3/h	1060/760
Niveau de pression sonore à 1,5m (GV/PV)	dB(A)	39/33
Niveau de puissance sonore (GV/PV)	dB(A)	54/48
Dimensions (HxLxP)	mm	210 × 1100 × 450
Poids	kg	22
Liaisons frigorifiques (gaz - liquide)	pouce	1/2 - 1/4
Pressions disponibles *	Pa	10 / 20 / 35 / 45

* Réglage usine : pression minimum.

Dimensions

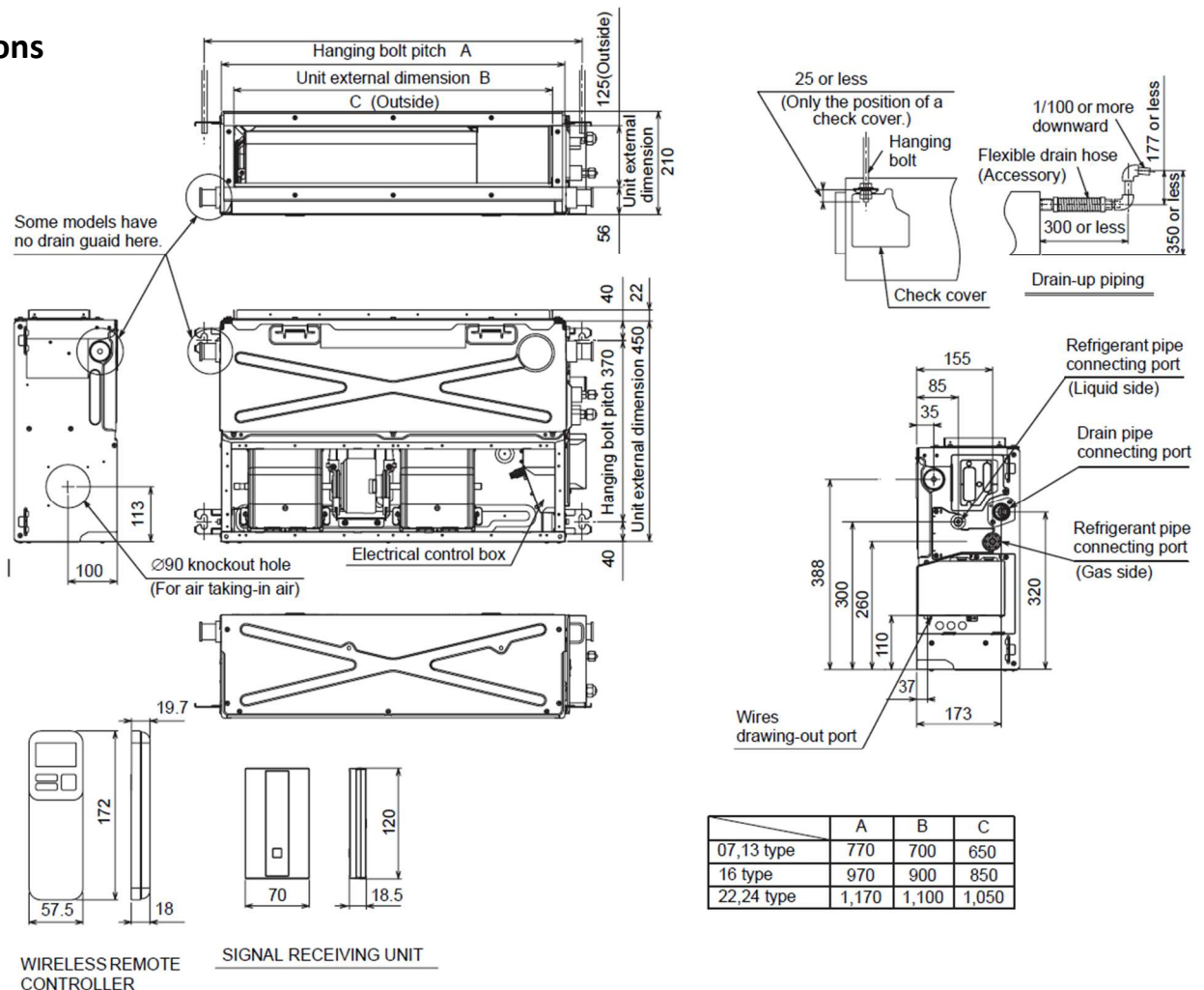

0810723723

Service 0,05 €/ appel + prix appel