

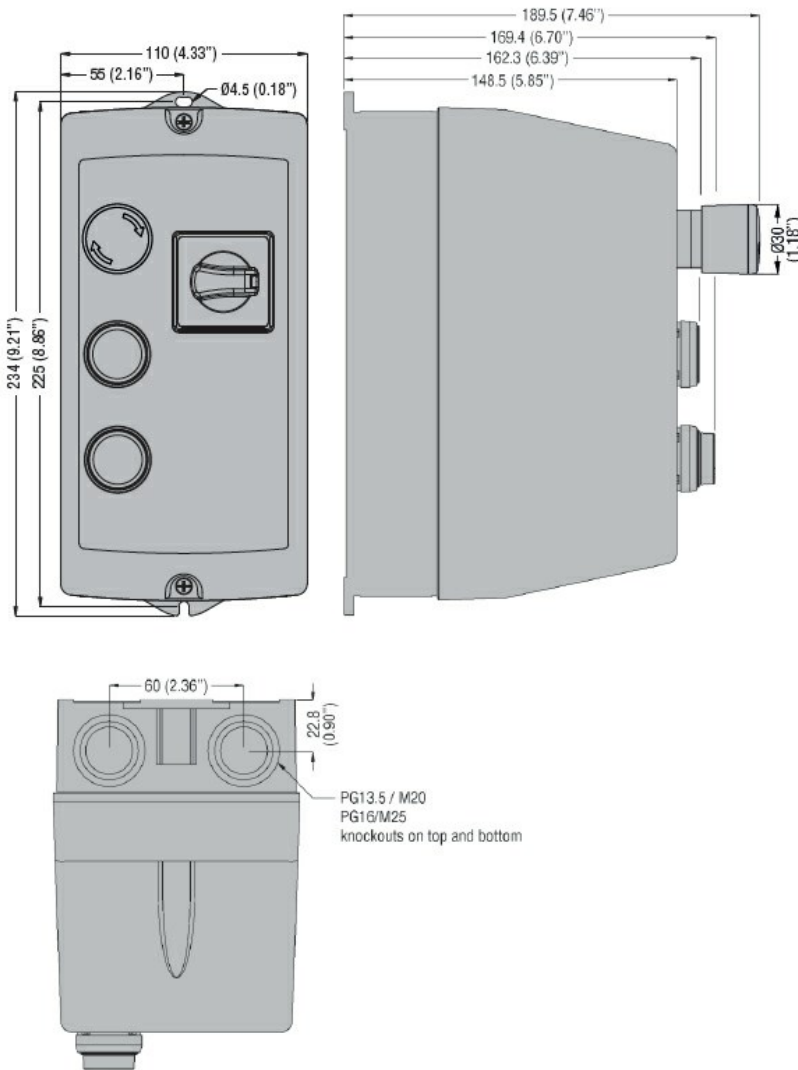

Product designation	Direct-on-line starter		
Product type designation	M2P00911		
Electrical features			
Relay adj range	A	9-14	
IEC technical characteristics ($\leq 440V$)			
	le	A	14
	kW	kW	5.5
Mechanical features			
Weight	g	1515	
Ambient conditions			
Operating temperature			
	min	°C	-25
	max	°C	+60
Storage temperature			
	min	°C	-40
	max	°C	+70
Resistance & Protection			
Frontal IP degree	IP65		
Dimensions			



Wiring diagrams

Incorporated button control
and rotary actuator for 3-phase motors

Power
connection for 1-phase
motors

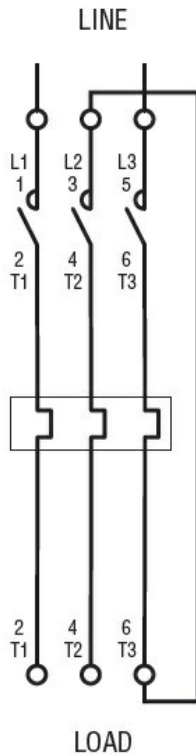
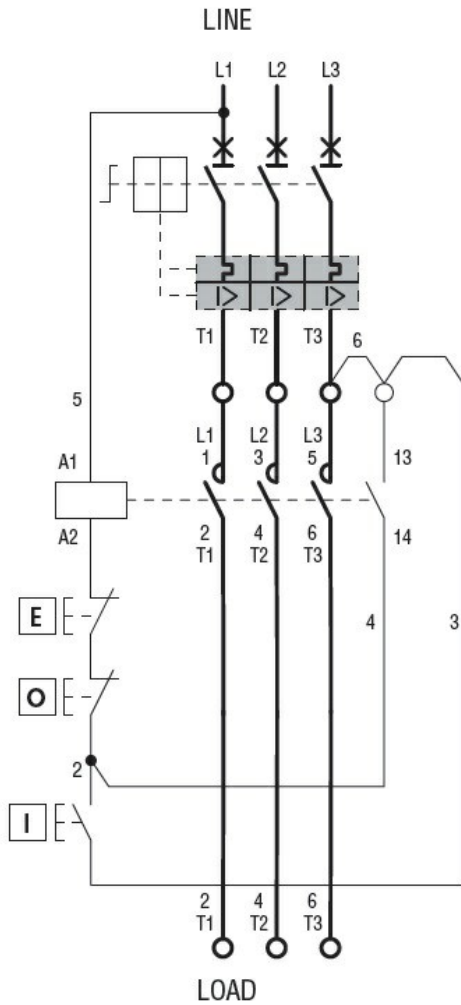

I = Start; O = Stop; E = Emergency Stop

Certifications and compliance

Compliance

IEC/EN 60947-1
IEC/EN 60947-4-1

Certificates

EAC

ETIM classification

ETIM 8.0

EC001037 -
Motor
starter/Motor
starter
combination