



# M40E-042223RB0

M4000 Advanced

**SAFETY MULTIBEAM SENSORS**

**SICK**  
Sensor Intelligence.



### Ordering information

| Scanning range               | Number of beams | Beam separation | System part | Type           | Part no. |
|------------------------------|-----------------|-----------------|-------------|----------------|----------|
| 0.5 m ... 70 m, configurable | 4               | 220 mm          | Receiver    | M40E-042223RB0 | 1210279  |

Other models and accessories → [www.sick.com/M4000\\_Advanced](http://www.sick.com/M4000_Advanced)

Illustration may differ



### Detailed technical data

#### Features

|                                    |                              |
|------------------------------------|------------------------------|
| <b>Scanning range</b>              | 0.5 m ... 70 m, configurable |
| <b>Low scanning range</b>          | 0.5 m ... 20 m               |
| <b>Great scanning range</b>        | 9 m ... 70 m                 |
| <b>Number of beams</b>             | 4                            |
| <b>Beam separation</b>             | 220 mm                       |
| <b>Response time</b>               | 10 ms                        |
| <b>Synchronization</b>             | Optical synchronisation      |
| <b>End cap with integrated LED</b> | ✓                            |

#### Safety-related parameters

|   |  |
|---|--|
| <b>Type</b>   | Type 4 (IEC 61496-1)                   |
| <b>Safety integrity level</b>   | SIL 3 (IEC 61508)                      |
| <b>Category</b>   | Category 4 (EN ISO 13849)              |
| <b>Performance level</b>  | PL e (EN ISO 13849)                    |
| <b>PFH<sub>p</sub> (mean probability of a dangerous failure per hour)</b> | $6.6 \times 10^{-9}$ (EN ISO 13849)    |
| <b>T<sub>M</sub> (mission time)</b>                                       | 20 years (EN ISO 13849)                |
| <b>Safe state in the event of a fault</b>                                 | At least one OSSD is in the OFF state. |

#### Functions

|   | Functions | Delivery status     |
|---|-----------|---------------------|
| <b>Beam coding</b>                                | ✓         | Uncoded             |
| <b>Restart interlock</b>                          | ✓         | Internal            |
| <b>External device monitoring (EDM)</b>           | ✓         | Activated           |
| <b>Sender test</b>                                | ✓         | Deactivated         |
| <b>Configurable scanning range</b>                | ✓         | 0.5 m ... 20 m      |
| <b>Configurable application diagnostic output</b> | ✓         | Contamination (OWS) |

|   | Functions                              | Delivery status |
|---|--|-----------------|
| Safe SICK device communication via EFI            | ✓                                      |                 |
| Differentiation between man and material (muting) | ✓                                      |                 |
| Type of human-material differentiation            | Flexible, configurable 4-signal muting |                 |

## Interfaces

|                                    |   |  |
|------------------------------------|---|--|
| <b>System connection</b>           | Hirschmann male connector M26, 12-pin               |  |
| Permitted cable length             | 50 m <sup>1)</sup>                                  |  |
| Permitted cross-section            | ≥ 0.75 mm <sup>2</sup>                              |  |
| <b>Configuration connection</b>    | Female connector M8, 4-pin                          |  |
| <b>Configuration method</b>        | PC with CDS (Configuration and Diagnostic Software) |  |
| <b>Display elements</b>            | LEDs<br>7-segment display                           |  |
| <b>End cap with integrated LED</b> | ✓   |  |

<sup>1)</sup> Depending on load, power supply and wire cross-section. The technical specifications must be observed.

## Electrical data

|  |  |  |
|--|--|--|
| <b>Protection class</b>                        | III (IEC 61140)  |  |
| <b>Supply voltage <math>V_S</math></b>         | 24 V DC (19.2 V DC ... 28.8 V DC) <sup>1)</sup>                                      |  |
| <b>Residual ripple</b>                         | ≤ 10 % <sup>2)</sup>   |  |
| <b>Power consumption</b>                       | ≤ 0.6 A <sup>3)</sup>  |  |
| <b>Output signal switching devices (OSSDs)</b> | 2 PNP semiconductors, short-circuit protected, cross-circuit monitored <sup>4)</sup> |  |
| ON state, switching voltage HIGH               | 24 V DC ( $V_S - 2.25$ V DC ... $V_S$ )  |  |
| OFF state, switching voltage LOW               | ≤ 2 V DC   |  |
| Current-carrying capacity per OSSD             | ≤ 500 mA   |  |

<sup>1)</sup> The external voltage supply must be capable of buffering brief mains voltage failures of 20 ms as specified in EN 60204-1. Suitable power supplies are available as accessories from SICK.

<sup>2)</sup> Within the limits of  $V_S$ .

<sup>3)</sup> Without load.

<sup>4)</sup> Applies to the voltage range between -30 V and +30 V.

## Mechanical data

|                              |  |  |
|------------------------------|--|--|
| <b>Dimensions</b>            | See dimensional drawing                  |  |
| <b>Housing cross-section</b> | 52 mm x 55.5 mm                          |  |
| <b>Material</b>              |  |  |
| Housing                      | Aluminum alloy ALMGSI 0.5, powder coated |  |
| Front screen                 | Polycarbonate, scratch-resistant coating |  |

## Ambient data

|                                      |                               |  |
|--------------------------------------|-------------------------------|--|
| <b>Enclosure rating</b>              | IP65 (EN 60529)               |  |
| <b>Ambient operating temperature</b> | -30 °C ... +55 °C             |  |
| <b>Storage temperature</b>           | -30 °C ... +70 °C             |  |
| <b>Air humidity</b>                  | 15 % ... 95 %, Non-condensing |  |
| <b>Shock resistance</b>              | 10 g, 16 ms (IEC 60068-2-29)  |  |

### Other information

|                    |        |
|--------------------|--------|
| <b>Wave length</b> | 850 nm |
|--------------------|--------|

### Classifications

|                       |          |
|-----------------------|----------|
| <b>eCl@ss 5.0</b>     | 27272703 |
| <b>eCl@ss 5.1.4</b>   | 27272703 |
| <b>eCl@ss 6.0</b>     | 27272703 |
| <b>eCl@ss 6.2</b>     | 27272703 |
| <b>eCl@ss 7.0</b>     | 27272703 |
| <b>eCl@ss 8.0</b>     | 27272703 |
| <b>eCl@ss 8.1</b>     | 27272703 |
| <b>eCl@ss 9.0</b>     | 27272703 |
| <b>eCl@ss 10.0</b>    | 27272703 |
| <b>eCl@ss 11.0</b>    | 27272703 |
| <b>eCl@ss 12.0</b>    | 27272703 |
| <b>ETIM 5.0</b>       | EC001832 |
| <b>ETIM 6.0</b>       | EC001832 |
| <b>ETIM 7.0</b>       | EC001832 |
| <b>ETIM 8.0</b>       | EC001832 |
| <b>UNSPSC 16.0901</b> | 46171620 |

Dimensional drawing (Dimensions in mm (inch))

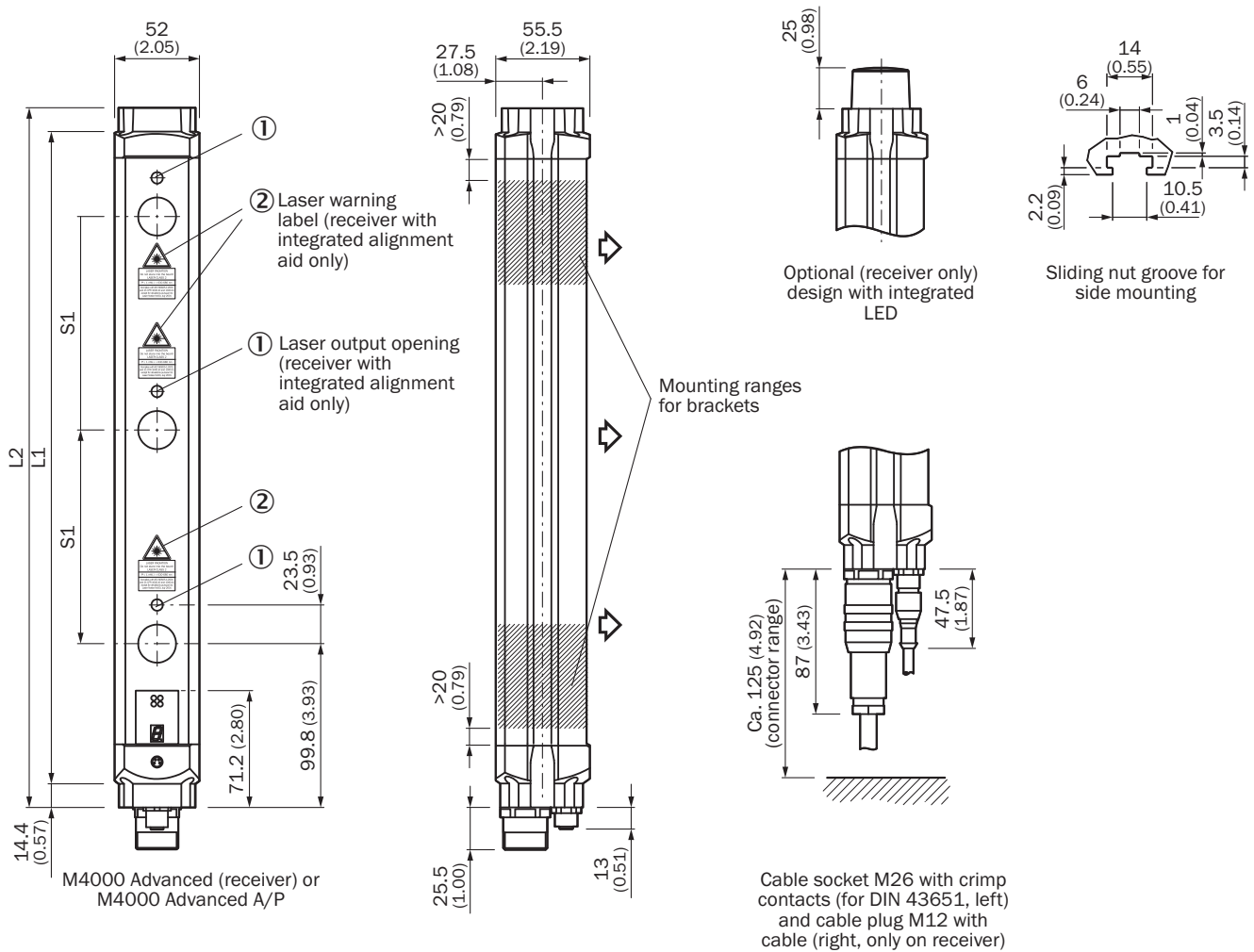









Illustration sender (receiver mirror image)

| Number of beams | Beam separation S1 | L1            | L2            |
|-----------------|--------------------|---------------|---------------|
| 2               | 500 (19.69)        | 643 (25.31)   | 672 (26.46)   |
|                 | 600 (23.62)        | 743 (29.25)   | 772 (30.39)   |
| 3               | 220 (8.66)         | 583 (22.95)   | 612 (24.09)   |
|                 | 400 (15.75)        | 943 (37.13)   | 972 (38.27)   |
|                 | 450 (17.72)        | 1,043 (41.06) | 1,072 (42.20) |
| 4               | 220 (8.66)         | 803 (31.61)   | 832 (32.76)   |
|                 | 300 (11.81)        | 1,043 (41.06) | 1,072 (42.20) |
| 5               | 220 (8.66)         | 1,023 (40.28) | 1,052 (41.42) |
| 6               |                    | 1,243 (48.94) | 1,272 (50.08) |
| 7               |                    | 1,462 (57.56) | 1,491 (58.70) |
| 8               |                    | 1,682 (66.22) | 1,711 (67.36) |

### Recommended accessories

Other models and accessories → [www.sick.com/M4000\\_Advanced](http://www.sick.com/M4000_Advanced)

|   | Brief description  | Type   | Part no. |
|---|--|--|----------|
| <b>Alignment aids</b>   |  |  |          |
|    | Laser alignment aid for various sensors, laser class 2 (IEC 60825). Do not look into the beam!, 19 mm x 67.3 mm x 66.9 mm  | AR60   | 1015741  |
|    | Adapter AR60 for M4000 and M4000 Curtain   | AR60 adapter, M4000                              | 4040006  |
| <b>Muting accessories</b>   |  |  |          |
|    | Parallel muting (2 sensors), muting sensor brackets for mounting on M4000 housing profile or device columns with external mounting grooves   | Muting arm kit M4000, 2 sensors, parallel muting | 2060157  |
|    | Parallel muting (2 sensors), muting sensor brackets for mounting on M4000 housing profile or device column with external mounting grooves  |  | 2060156  |
| <b>Mounting brackets and plates</b>   |  |  |          |
|    | 4 pieces, Mounting kit 1, mounting bracket, rigid, L-shaped, including fixing screws and washers   | BEF-3WNGBAST4                                    | 7021352  |
| <b>Plug connectors and cables</b>   |  |  |          |
|   | Head A: female connector, M26, 12-pin, straight<br>Head B: Flying leads<br>Cable: Sensor/actuator cable, PVC, unshielded, 5 m  | DOL-0612G05M075KM0                               | 2022545  |
|   | Head A: female connector, M26, 12-pin, straight<br>Head B: Flying leads<br>Cable: Sensor/actuator cable, PVC, unshielded, 10 m   | DOL-0612G10M075KM0                               | 2022547  |
|  | Head A: female connector, M26, 12-pin, straight<br>Head B: Flying leads<br>Cable: Sensor/actuator cable, PVC, unshielded, 20 m   | DOL-0612G20M075KM0                               | 2022549  |
|   | Head A: male connector, M8, 4-pin, straight<br>Head B: male connector, USB-A, straight<br>Cable: PVC, unshielded, 2 m  | DSL-8U04G02M025KM1                               | 6034574  |
|   | Head A: male connector, M8, 4-pin, straight<br>Head B: male connector, USB-A, straight<br>Cable: PVC, unshielded, 10 m   | DSL-8U04G10M025KM1                               | 6034575  |
|  | Head A: female connector, M12, 5-pin, straight, A-coded<br>Head B: male connector, M12, 5-pin, straight, A-coded<br>Cable: Sensor/actuator cable, PUR, halogen-free, unshielded, 2 m   | YF2A15-020UB5M2A15                               | 2096009  |
|   | Head A: female connector, M12, 5-pin, straight, A-coded<br>Head B: male connector, M12, 5-pin, straight, A-coded<br>Cable: Sensor/actuator cable, PUR, halogen-free, unshielded, 0.6 m | YF2A15-C60UB5M2A15                               | 2096006  |
|  | Head A: female connector, M26, 12-pin, straight<br>Cable: unshielded<br>12 crimping contacts enclosed  | DOS-0612G000GA3KM0                               | 6020757  |
|  | Head A: female connector, M26, 12-pin, angled<br>Cable: unshielded<br>12 crimping contacts enclosed  | DOS-0612W000GA3KM0                               | 6020758  |

|   | Brief description  | Type          | Part no. |
|---|--|---------------|----------|
| Terminal and alignment brackets   |  |               |          |
|  | 4 pieces, Mounting kit 6, side bracket, rotatable, zinc diecast  | BEF-1SHABAZN4 | 2019506  |
|  | 4 pieces, Omega bracket, rotatable, fixable with only one screw, for mounting on the swivel mount, including spacer discs  | BEF-2SMGEAAL4 | 2044846  |
|  | 4 pieces, Mounting kit 12, rotatable, swivel mount   | BEF-2SMGEAKU4 | 2030510  |
| Switching amplifiers  |  |               |          |
|  | <ul style="list-style-type: none"> <li>• <b>Applications:</b> Muting switching amplifier</li> <li>• <b>Compatible sensor types:</b> M4000 Advanced multiple light beam safety devices</li> </ul> | UE403-A0930   | 1026287  |

## SICK AT A GLANCE

SICK is one of the leading manufacturers of intelligent sensors and sensor solutions for industrial applications. A unique range of products and services creates the perfect basis for controlling processes securely and efficiently, protecting individuals from accidents and preventing damage to the environment.

We have extensive experience in a wide range of industries and understand their processes and requirements. With intelligent sensors, we can deliver exactly what our customers need. In application centers in Europe, Asia and North America, system solutions are tested and optimized in accordance with customer specifications. All this makes us a reliable supplier and development partner.

Comprehensive services complete our offering: SICK LifeTime Services provide support throughout the machine life cycle and ensure safety and productivity.

For us, that is “Sensor Intelligence.”

## WORLDWIDE PRESENCE:

Contacts and other locations –[www.sick.com](http://www.sick.com)