



Product designation	Rotary cam switches
Product type designation	GF20
General characteristics	
Switching diagram	10 - ON/OFF switch 3 poles
N° of elements	2
Mounting form	O48 - Modular service cover for 35mm din rail mounting with black handle

Contact characteristics

Rated insulation voltage U_i	IEC/EN	V	480
	UL/CSA	V	240
Rated impulse withstand voltage U_{imp}		kV	4
Conventional free air thermal current I_{th}	IEC/EN	A	20
	UL/CSA	A	15
Rated operational voltage		V	480
Rated operational impulse voltage		kV	4
Maximum fuse size for short-circuit protection I_n (gG)	10kA	A	20
	15kA	A	20
	25kA	A	20
Rated short time current I_{cw}		1s	A
			250
Conductivity			10/5 mA/V
Operational current I_e IEC/EN	AC1/AC21A		A
			20
AC15	110V	A	10
	220/230V	A	8
	380/400V	A	6
Rated operational power in AC	Three-phase AC-3		
	220/230V	kW	3
	380/440V	kW	5
	Single-phase AC-3		
	110V	kW	0.5
	220/230V	kW	1.5
380/440V	kW	2	
Three-phase AC23A	220/230V	kW	4

	380/440V	kW	7.5
Single-phase AC23A			
	110V	kW	0.75
	220/230V	kW	2
	380/440V	kW	2.5
Rated operational current in DC			
DC21A			
	48V	A	20
	60V	A	20
	110V	A	4
	220V	A	0.7
	440V	A	0.2
DC13			
	24V	A	6
	48V	A	6
	60V	A	3
	110V	A	1
	220V	A	0.4
	440V	A	0.15
Power dissipation		W	0.8
Mechanical features			
Terminals screw			M3
Tightening torque for terminals max		Nm	0.5
Conductor size			
AWG - Rigid cable			
	min	AWG	20
	Max	AWG	12
AWG - Flexible cable			
	min	AWG	20
	Max	AWG	12
Conductor size (IEC) - Flexible cable			
	min	mm ²	0.5
	Max	mm ²	2.5
Conductor size (IEC) - Rigid cable			
	min	mm ²	0.5
	Max	mm ²	2.5
Mechanical life		cycles	1x10 ⁶
UL technical data			
Motor power for direct-on-line control			
for three-phase motor			
	240V	HP	3
for single-phase motor			
	240V	HP	1
Ambient conditions			
Temperature			
Operating temperature			
	min	°C	-25
	max	°C	+55
Storage temperature			
	min	°C	-40
	max	°C	+70
Resistance & Protection			
Frontal IP degree			IP40
Terminals IP degree			IP20

Dimensions

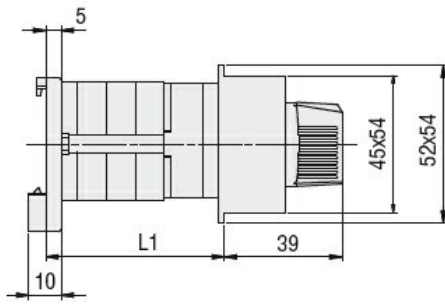

Series	L1		
	1	2	3
GF20	40	53.5	67

Wiring diagrams

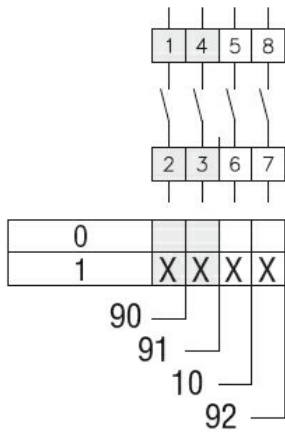

Certifications and compliance

Compliance

- CSA C22.2 n° 14
- IEC/EN/BS 60947-1
- IEC/EN/BS 60947-3
- IEC/EN/BS 60947-5-1
- UL60947-4-1

Certificates

- cULus
- EAC

ETIM classification

ETIM 8.0

EC001029 -
 Selector switch,
 complete