

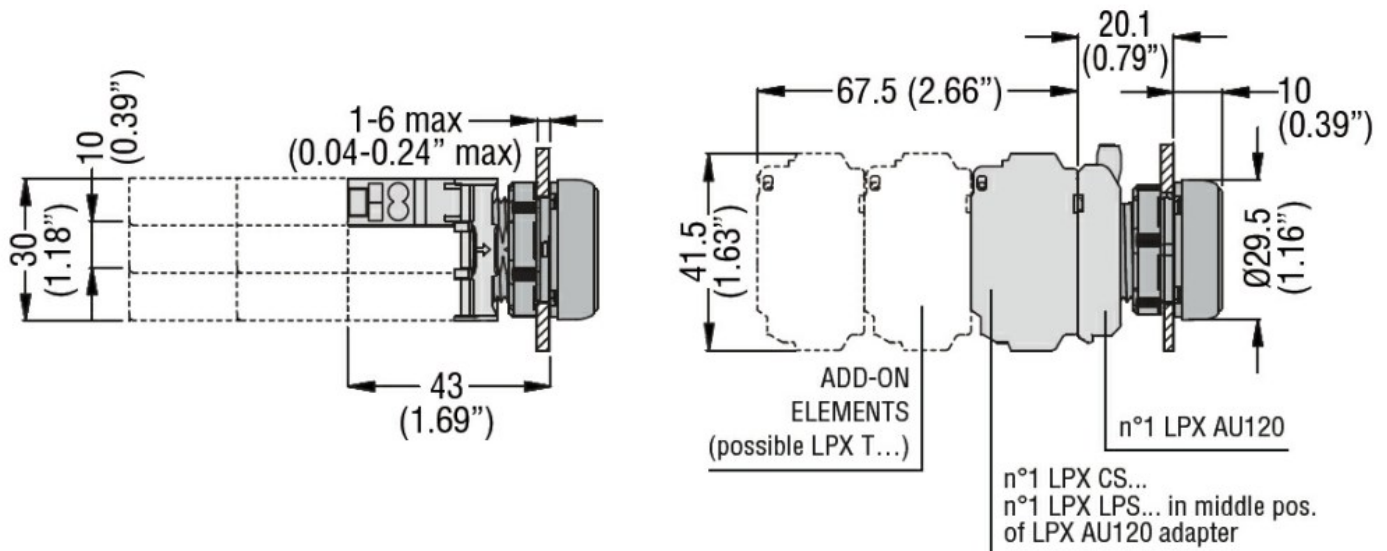

| | | | |
|-------------------------------------|---------------------------|-----------------|--------------|
| Product designation | LED elements steady light | | |
| Product type designation | LPXLF | | |
| General characteristics | | | |
| Colour | Green | | |
| Electrical characteristics | | | |
| Supply voltage (AC) | V | 85...140 | |
| Operations | | | |
| Electrical life | hours | 100000 | |
| Mechanical features | | | |
| Tightening torque for terminals max | Nm | 1 | |
| Conductor section | | | |
| AWG/kcmil conductor section | max | 12 | |
| IEC | max | mm ² | 1 or 2 / 2.5 |
| Mounting adapter | LPXAU120 | | |
| Weight | g | 16 | |
| Ambient conditions | | | |
| Temperature | | | |
| Operating temperature | min | °C | -25 |
| | max | °C | +70 |
| Storage temperature | min | °C | -40 |
| | max | °C | +85 |

Dimensions



Wiring diagrams

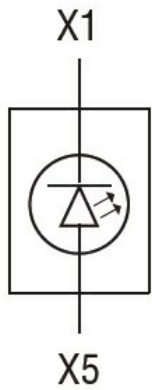

Certifications and compliance

Compliance

CSA C22.2 n° 14
IEC/EN/BS 60947-1
IEC/EN/BS 60947-5-1
UL508

Certificates

CCC
cULus
EAC
RINA
UL

ETIM classification

ETIM 8.0

EC000204 -
Lamp holder
block for control
circuit devices