

HERO B

108757.20 + 108916.99

novalux
ITALIAN LIGHTING DESIGN SINCE 1948

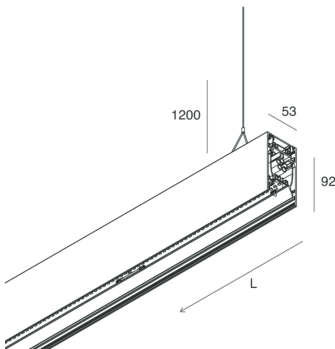
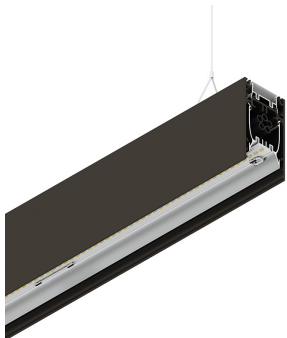

Features

Use: Indoor
Type of installation: SUSPENDED
Emission: DIRECT/INDIRECT
Optics: MICROPRISMATIZED
Colour: CAFFE
Dimming: DALI
Emergency: NO
L: 2800mm
A: 53mm
H: 92mm
Made in: ITALY
Warranty: 5 years
Weight: 10kg

Tech data

Luminaire input power: 132.5W
Luminaire luminous flux: 12565lm
Indirect luminous flux: 6678lm
IP: 40
Insulation class: I
Supply voltage: 220-240V 50/60Hz
UGR: <19
SELV: Si

Source

Light source: LED
Source power: 113W
Colour temperature: 4000K
CRI: >90
Colour tolerance: 3 Step MacAdam
LED lifespan: 50000h L80 B20

Compliance

CEI EN 60598-1:2021 + A11:2023, CEI EN 60598-2-1:2022

Standards

Photobiological risk: RISK GROUP 0 Certified fixture in EXEMPT GROUP, in accordance with CEI EN 62471:2010-01, IEC TR 62778:2014.
CAM edilizia: The product complies with the requirements for public buildings, ministerial decree of 23rd June 2022 n.256.

Average luminance

Average luminance limits for DSE workstation 65°(in accordance to EN 12464-1:2012).

[View more product info](#)



Novalux S.r.l. via Marzabotto, 2 40050 Funo di Argelato (BO) Italy
Tel: +39 051 860558 · Fax +39 051 6647859 · Mail: info@novalux.it · VAT number 00536541204 · novalux.com
Company subject to the management and coordination by SLV GmbH







This technical data sheet is owned by Novalux S.r.l., all rights reserved. Novalux S.r.l. reserves the right to make changes without prior notice.
Last update: 21/3/2024, 17:19:46

HERO B

108757.20 + 108916.99

novalux
ITALIAN LIGHTING DESIGN SINCE 1948

COMPLETION ACCESSORIES

	HERO B: COPPIA TESTATE CAF	1087B1.20
	HERO B: MOD.CIECO 1680 CAF	1087A8.20
	HERO B: MOD.CIECO 1400 CAF	1087A7.20
	HERO B: MOD.CIECO ANG.DX 150 CAF	1087A5.20
	HERO B: MOD.CIECO 250 CAF	1087A3.20
	HERO B: MOD.CIECO ANG.SX 150 CAF	1087A4.20
	HERO B: MOD.CIECO 1120 CAF	1087A6.20

MOUNTING ACCESSORIES

	HERO B: KIT COPPIA CAVI SOSP. 5 M	1087B2.99
	KIT ALIMENTAZIONE L1200 5P BIA	108921.01
	KIT ALIMENTAZIONE L3000 5P BIA	108922.01
	KIT ALIMENTAZIONE L3000 5P CAF	108922.20



Novalux S.r.l. via Marzabotto, 2 40050 Funo di Argelato (BO) Italy
Tel: +39 051 860558 · Fax +39 051 6647859 · Mail: info@novalux.it · VAT number 00536541204 · novalux.com
Company subject to the management and coordination by SLV GmbH

This technical data sheet is owned by Novalux S.r.l., all rights reserved. Novalux S.r.l. reserves the right to make changes without prior notice.
Last update: 21/3/2024, 17:19:46

HERO B

108757.20 + 108916.99

novalux
ITALIAN LIGHTING DESIGN SINCE 1948



KIT ALIMENTAZIONE L1200 5P CAF

108921.20



Novalux S.r.l. via Marzabotto, 2 40050 Funo di Argelato (BO) Italy
Tel: +39 051 860558 · Fax +39 051 6647859 · Mail: info@novalux.it · VAT number 00536541204 · novalux.com
Company subject to the management and coordination by SLV GmbH

This technical data sheet is owned by Novalux S.r.l., all rights reserved. Novalux S.r.l. reserves the right to make changes without prior notice.
Last update: 21/3/2024, 17:19:46