



Product designation

Roller centre
push lever

Product type designation

KNC

General characteristics

Material

Housing

Aluminium-zinc
alloy

Roller

Plastic

Contact characteristics

Type of contact

2NO Slow action

Thermal current I_{th}

A

10

IEC/EN 60947-5-1 designation

A300 Q300

Rated insulation voltage U_i

V

440

Rated impulse withstand voltage U_{imp}

kV

4

Short-circuit protection with fuse

Class/A

10 gG/SC
QUICK FUSE

Switching speed

min

m/s

0.5

max

m/s

1.5

IEC Conventional free air thermal current I_{th}

A

10

Resistance per pole (average value)

mΩ

<10

Mechanical features

Operating head fixing

Locking bayonet
insert

Operating torque

N

6

lb

1.34

Tightening torque (Max)

Switch fixing

Nm

2.5

lbin

22.1

Contact terminals

Nm

0.8

lbin

7

Body lid screw fixing

Nm

0.8

lbin

7

Conductor section

AWG/Kcmil

min

16

max

14

IEC

min

mm²

1 or 2

max

mm²

2.5

Cable connection

Self-releasing
screw terminal

Cable entry M20 on the sides

Operations

Mechanical life cycles <1000000
Mechanical operation cycles/h 3600

Ambient conditions

Temperature

Operating temperature

min °C -25
max °C +70

Storage temperature

min °C -40
max °C +70

Resistance & Protection

IP degree

Terminals IP20
Body housing IP65

Pollution degree

3

Dimensions

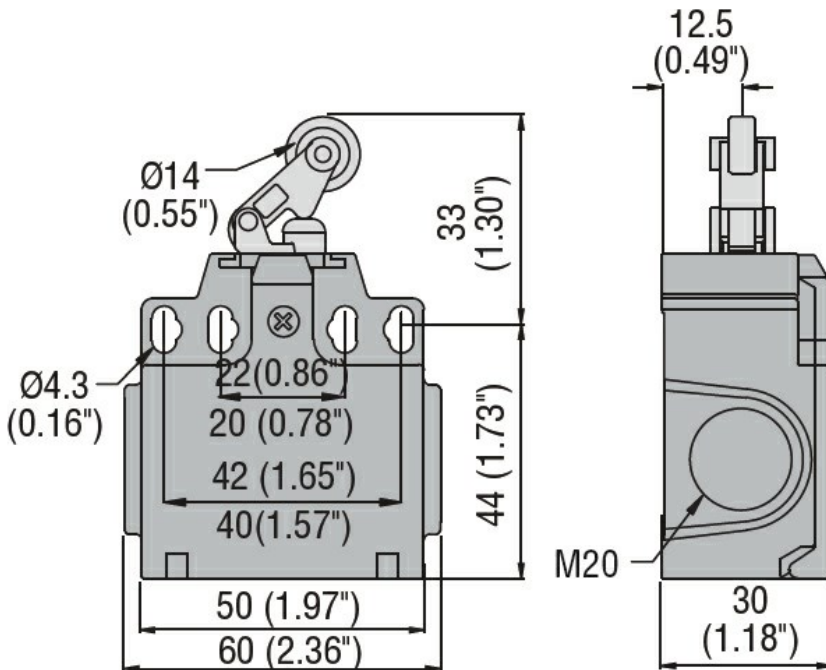

Wiring diagrams

Slow action

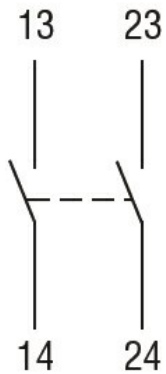

2NO

Certifications and compliance

Compliance

CSA C22.2 n° 14

EN 50047

IEC/EN 60204-1

IEC/EN 60947-1

IEC/EN 60947-5-1

UL508

Certificates

CCC

cULus

EAC

ETIM classification

ETIM 8.0

EC000030 - End
switch