



IP65



IK09



750°



Zéro Halogène

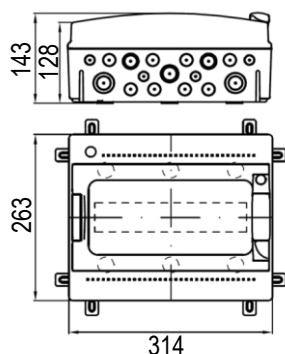
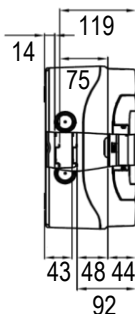

RoHS

SCHEMAS ET COTES (mm)
Dimensions

Réglages des profilés

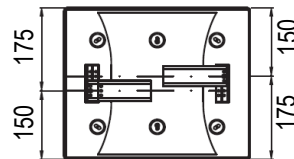
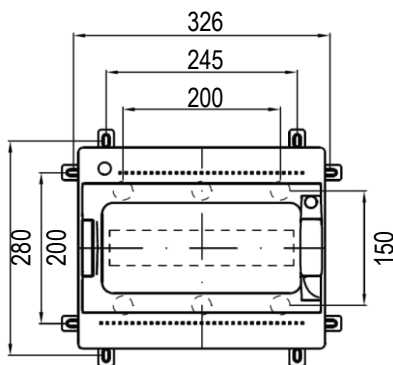
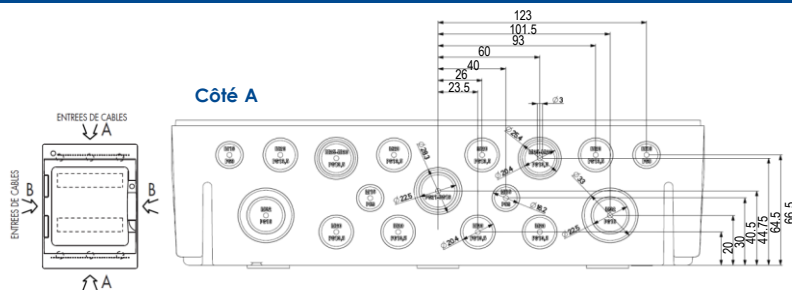
119 et 92 : distance entre le profilé et la porte
75 et 48 : distance entre le profilé et le plastron modulaire
44 : distance entre le plastron modulaire et la porte

Réglages des profilés (entraxe)

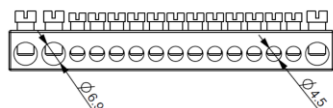
Entraxes de fixation

Prédécoupes des entrées de câbles

Type	Côté A						Côté B		
	M50 PG29	M32 PG16	M25 M20 PG13,5	M20 PG21	M20 PG13,5	M16 PG9	M21 PG16	M32 M25	M20 M16 PG9
Nombre	-	2	2	-	8	4	1	2	-

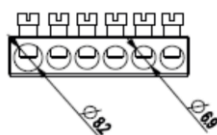
Bornier de terre

Entrées borniers à vis

Section	1,5 à 10 mm ²	6 à 25 mm ²
Nombre	12	3

Bornier phase ou neutre

Entrées borniers

Section	35 mm ²	25mm ²
Nombre	1	5

Kit de jumelage A-KIT
