



Adjustable rod lever
KCL

Product designation

Product type designation

General characteristics

Material

Housing

Rod

Polymer thermoplastic
Aluminium-zinc alloy

Contact characteristics

Type of contact		2NO Slow action
Thermal current I _{th}	A	10
IEC/EN 60947-5-1 designation		A600 Q300
Rated insulation voltage U _i	V	690
Rated impulse withstand voltage U _{imp}	kV	6
Insulation class		II
Short-circuit protection with fuse	Class/A	10 gG/SC QUICK FUSE
Switching speed	min	m/s 0.5
	max	m/s 1.5
IEC Conventional free air thermal current I _{th}	A	10
Resistance per pole (average value)	mΩ	<10

Mechanical features

Operating head fixing		Locking bayonet insert
Operating torque	Ncm	3
	ozin	4.25
Tightening torque (Max)		
Switch fixing	Nm	2.5
	lbin	22.1
Contact terminals	Nm	0.8
	lbin	7
Body lid screw fixing	Nm	0.8
	lbin	7
Conductor section		
AWG/Kcmil	min	16
	max	14
IEC	min	mm ² 1or 2
	max	mm ² 2.5

Cable connection	Self-releasing screw terminal
Cable entry	M20 on the sides

Operations

Mechanical life	cycles	<10000000
Mechanical operation	cycles/h	3600

Ambient conditions

Temperature	Operating temperature	min	°C	-25
		max	°C	+70
	Storage temperature	min	°C	-40
		max	°C	+70

Resistance & Protection

IP degree	Terminals	IP20
	Body housing	IP65
Pollution degree		3

Dimensions

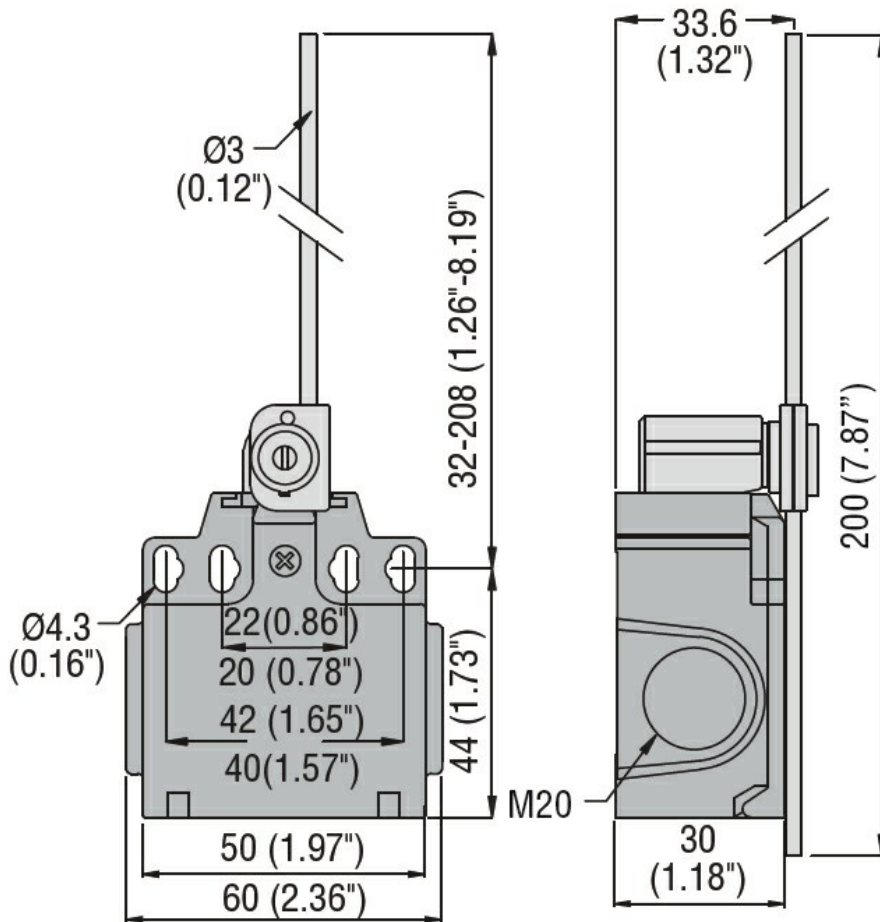

Wiring diagrams

Slow action

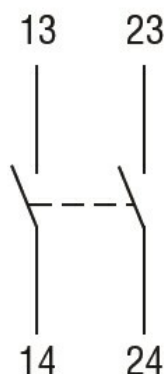

2NO

Certifications and compliance

Compliance

CSA C22.2 n° 14

EN 50047

IEC/EN 60204-1

IEC/EN 60947-1

IEC/EN 60947-5-1

UL508

Certificates

CCC

cULus

EAC

ETIM classification

ETIM 8.0

EC000030 - End
switch