



Product designation Power contactor
Product type designation BF65

Contact characteristics

Number of poles	Nr.	3
Rated insulation voltage U _i IEC/EN	V	1000
Rated impulse withstand voltage U _{imp}	kV	8
Operational frequency	min	Hz 25
	max	Hz 400
IEC Conventional free air thermal current I _{th}	A	100
Operational current I _e	AC-1 (≤40°C)	A 100
	AC-1 (≤55°C)	A 80
	AC-1 (≤70°C)	A 70
	AC-3 (≤440V ≤55°C)	A 65
	AC-4 (400V)	A 31
Rated operational power AC-3 (T≤55°C)	230V	kW 18.5
	400V	kW 30
	415V	kW 37
	440V	kW 37
	500V	kW 37
	690V	kW 45
	1000V	kW 30
Rated operational current AC-3 (T≤55°C)	230V	A 65
	400V	A 65
	415V	A 65
	440V	A 65
	500V	A 53
	690V	A 47
	1000V	A 25
Rated operational power AC-1 (T≤40°C)	230V	kW 38
	400V	kW 65
	500V	kW 82
	690V	kW 114
IEC max current I _e in DC1 with L/R ≤ 1ms with 1 poles in series	≤24V	A 50
	48V	A 50
	75V	A 50
	110V	A 8
	220V	A –
IEC max current I _e in DC1 with L/R ≤ 1ms with 2 poles in series	≤24V	A 70

	48V	A	70
	75V	A	70
	110V	A	60
	220V	A	9
<hr/>			
IEC max current I _e in DC1 with L/R ≤ 1ms with 3 poles in series			
	≤24V	A	70
	48V	A	70
	75V	A	70
	110V	A	60
	220V	A	90
<hr/>			
IEC max current I _e in DC1 with L/R ≤ 1ms with 4 poles in series			
	≤24V	A	70
	48V	A	70
	75V	A	70
	110V	A	70
	220V	A	110
<hr/>			
IEC max current I _e in DC3-DC5 with L/R ≤ 15ms with 1 poles in series			
	≤24V	A	35
	48V	A	25
	75V	A	25
	110V	A	3
	220V	A	–
<hr/>			
IEC max current I _e in DC3-DC5 with L/R ≤ 15ms with 2 poles in series			
	≤24V	A	45
	48V	A	40
	75V	A	40
	110V	A	30
	220V	A	5
<hr/>			
IEC max current I _e in DC3-DC5 with L/R ≤ 15ms with 3 poles in series			
	≤24V	A	55
	48V	A	50
	75V	A	50
	110V	A	35
	220V	A	52
<hr/>			
IEC max current I _e in DC3-DC5 with L/R ≤ 15ms with 4 poles in series			
	≤24V	A	60
	48V	A	60
	75V	A	60
	110V	A	50
	220V	A	65
<hr/>			
Short-time allowable current for 10s (IEC/EN60947-1)		A	640
<hr/>			
Protection fuse			
	gG (IEC)	A	125
	aM (IEC)	A	80
<hr/>			
Making capacity (RMS value)		A	650
<hr/>			
Breaking capacity at voltage			
	440V	A	520
	500V	A	425
	690V	A	376
<hr/>			
Resistance per pole (average value)		mΩ	0.8
<hr/>			
Power dissipation per pole (average value)			
	I _{th}	W	8
	AC-3	W	3.4
<hr/>			
Tightening torque for terminals			

		min	Nm	4
		max	Nm	5
		min	Ibin	2.95
		max	Ibin	3.69
Tightening torque for coil terminal				
		min	Nm	0.8
		max	Nm	1
		min	Ibin	0.8
		max	Ibin	0.74
Max number of wires simultaneously connectable				Nr. 2
Conductor section				
	AWG/Kcmil			
		max		2
Flexible w/o lug conductor section				
		min	mm ²	1.5
		max	mm ²	35
Flexible c/w lug conductor section				
		min	mm ²	1.5
		max	mm ²	35
Power terminal protection according to IEC/EN 60529				IP20 front
Mechanical features				
Operating position				
		normal allowable		Vertical plan ±30°
Fixing				Screw / DIN rail 35mm
Weight				g 1020
Conductor section				
	AWG/kcmil conductor section			
		max		2
Operations				
Mechanical life			cycles	15000000
Electrical life			cycles	1400000
Safety related data				
Performance level B10d according to EN/ISO 13489-1				
		rated load	cycles	1400000
		mechanical load	cycles	15000000
Mirror contacts according to IEC/EN 60947-4-1				yes
EMC compatibility				yes
AC coil operating				
Rated AC voltage at 60Hz			V	230
AC operating voltage				
	of 60Hz coil powered at 60Hz			
	pick-up	min	%Us	80
		max	%Us	110
	drop-out	min	%Us	20
		max	%Us	55
AC average coil consumption at 20°C				
	of 60Hz coil powered at 60Hz			
		in-rush	VA	210
		holding	VA	15

Dissipation at holding ≤20°C 50Hz		W	5
Max cycles frequency			
Mechanical operation		cycles/h	3600
Operating times			
Average time for Us control			
in AC			
Closing NO		min	ms 12
		max	ms 28
Opening NO		min	ms 8
		max	ms 22
in DC			
Closing NO		min	ms 40
		max	ms 85
Opening NO		min	ms 20
		max	ms 55
UL technical data			
Full-load current (FLA) for three-phase AC motor			
		at 480V	A 65
		at 600V	A 62
Yielded mechanical performance			
for three-phase AC motor			
		200/208V	HP 20
		220/230V	HP 25
		460/480V	HP 50
		575/600V	HP 60
General USE			
Contactor			
		AC current	A 100
Short-circuit protection fuse, 600V			
High fault			
		Short circuit current	kA 100
		Fuse rating	A 200
		Fuse class	J
Standard fault			
		Short circuit current	kA 10
		Fuse rating	A 200
		Fuse class	RK5
Ambient conditions			
Temperature			
Operating temperature		min	°C -50
		max	°C 70
Storage temperature		min	°C -60
		max	°C 80
Max altitude		m	3000
Resistance & Protection			
Pollution degree			3
Dimensions			

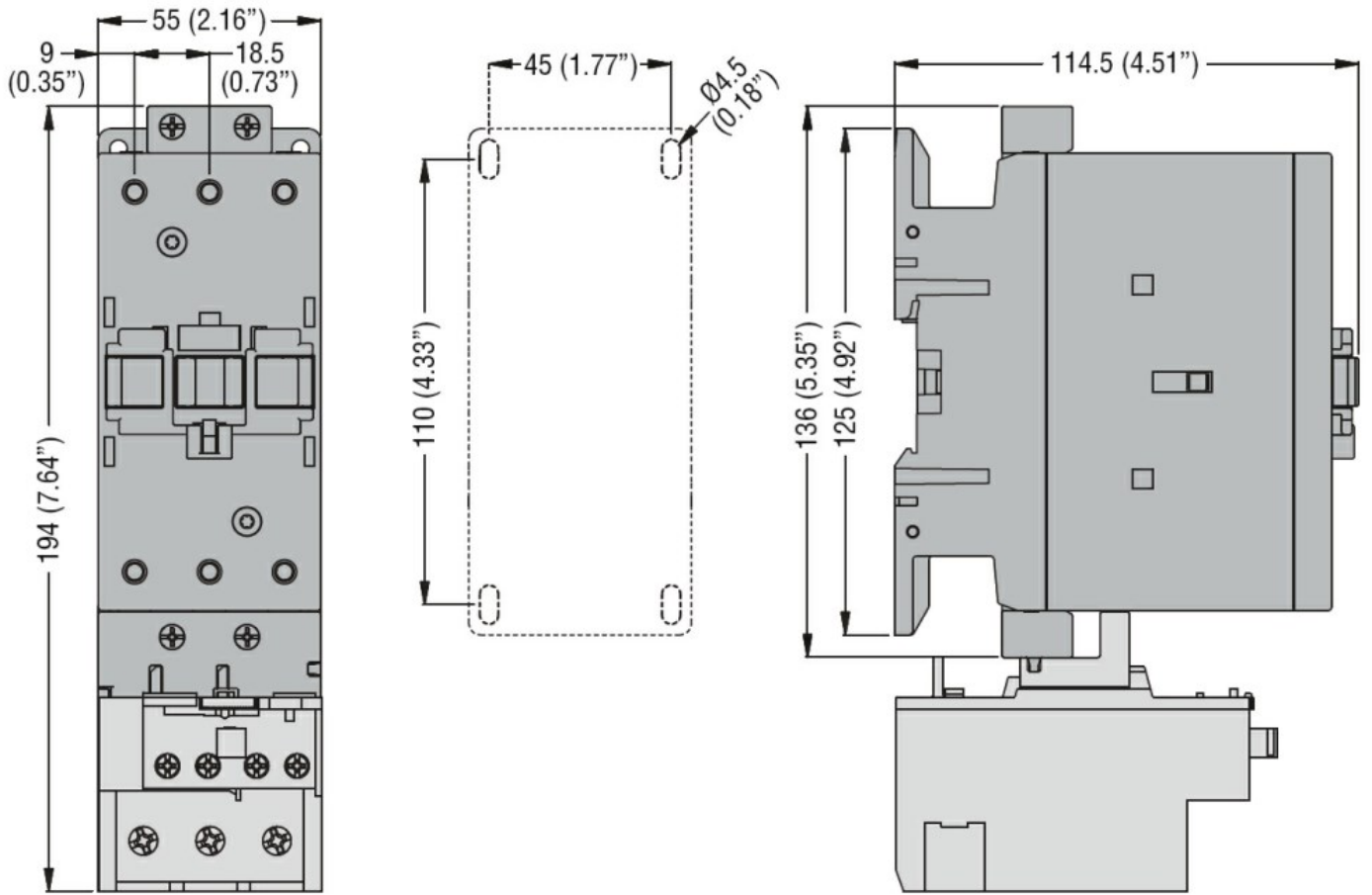

Wiring diagrams

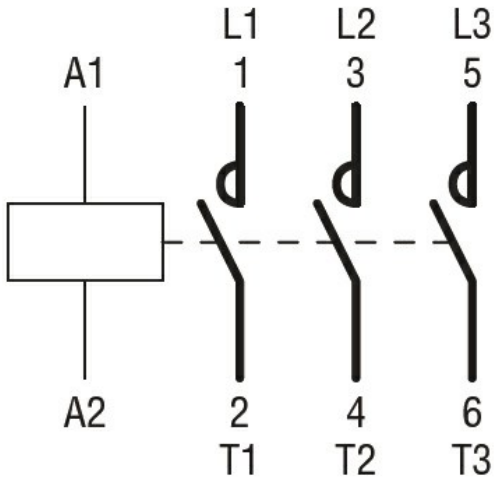

Certifications and compliance

Compliance

CSA C22.2 n° 60947-1
CSA C22.2 n° 60947-4-1
IEC/EN/BS 60947-1
IEC/EN/BS 60947-4-1
UL 60947-1
UL 60947-4-1

Certificates

CCC

cULus

ETIM classification

ETIM 8.0

EC000066 -
Power contactor,
AC switching