



Product designation

Current  
transformers  
DM0TW0020  
Wound primary

Product type designation

Type of CT

**Current inputs**

Primary current $I_{pn}$ (/5)	A	20
Operational frequency	min	Hz 50
	max	Hz 60
Secondary output current	A	5
Overload withstand $I_{pn}$	%	120
Burden	cl. 1	VA 3.75

**Insulations**

IEC rated short-time thermal current $I_{th}$	$I_{th}$ for s	40...60
IEC rated dynamic current $I_{dyn}$	$I_{th}$ for s	2.5
Insulation dry type		Class E

**Mechanical features**

Terminals type		Screw
Fixing		DIN rail or by Screw
Weight	g	279

**Ambient conditions**

Temperature	Operating temperature	min	°C	-25
		max	°C	+50
	Storage temperature	min	°C	-40
		max	°C	+80
Relative humidity		%	90	
Protection degree			IP30	

**Dimensions**

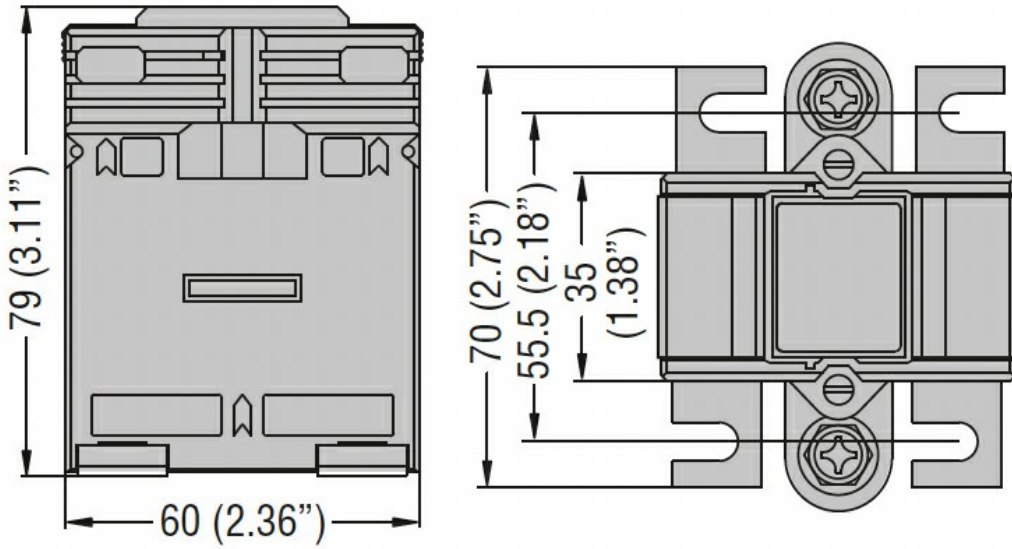

**Certifications and compliance**

Certifications

IEC/EN/BS 61869-1

IEC/EN/BS 61869-2

Compliance

CE

EAC

UKCA

**ETIM classification**

EC000066 - Power contactor, AC switching