

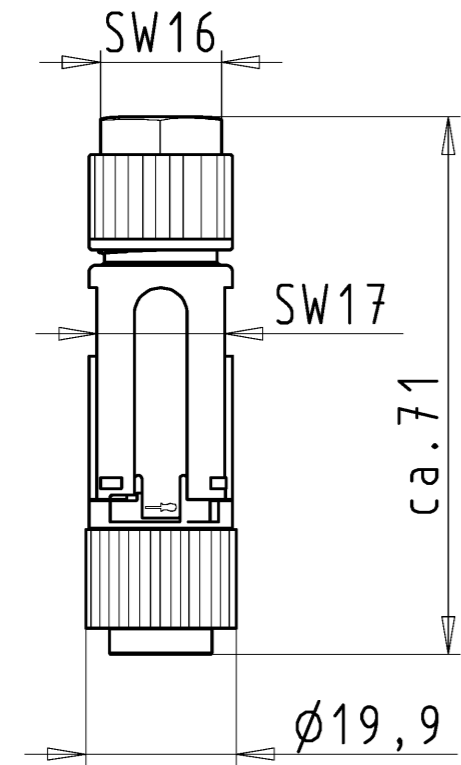





These dimensions will be especially checked at delivery
 Only inspection dimensions
 With /E marked dimensions are only valid for internal use
 Diese Maße werden bei Abnahme besonders geprüft
 Ausschließlich Prüfmaße
 Mit /E gekennzeichnete Maße sind nur für interne Zwecke gültig



Kodierung
/Coding

-  C1
-  C2
-  C3
-  C4
-  C5

Auslieferungszustand
/delivery condition

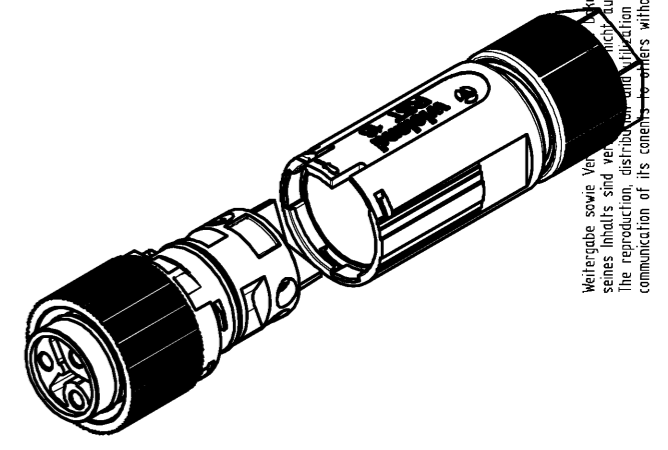
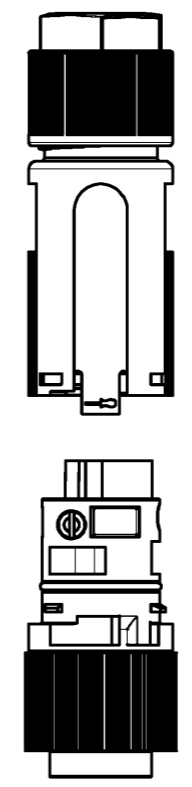

Weitergabe sowie Verwertung des Dokuments, Verwertung und Mitteilung seines Inhalts sind verbotlich.
 The reproduction, distribution and application of this document as well as the communication of its contents to others without express authorization is prohibited.

46.031.4550.6	RST16 I3	S B1 ZT4S A TB	C5	türkisblau /turquoise blue
46.031.4553.9	RST16 I3	S B1 ZT4S H BL	C4	lichtblau /light blue
46.031.4550.4	RST16 I3	S B1 ZT4S L BR	C3	signalbraun /signal brown
46.031.4555.7	RST16 I3	S B1 ZT4S GN	C2	laubgrün /leaf green
46.031.4553.1	RST16 I3	S B1 ZT4 SW	C1	schwarz /black
46.031.4553.0	RST16 I3	S B1 ZT4 GL	C1	lichtgrau /light grey

Bestellnummer /Order number	Typ /Type	Kodierung /Coding	Farbe /Colour
--------------------------------	--------------	----------------------	------------------

Weitere Daten siehe KATALOG oder eKatalog.
Additional data see CATALOG or eCatalog. www.wieland-electric.com
eshop.wieland-electric.com

Tolerierung Size ISO 14405 (Tolerance system Size ISO 14405).
 [This ISO-standard describes the envelope principle. According to the envelope principle the deviations of form and parallelism are limited by the size tolerances].

ja/yes Stoffverbots- und Deklarationsliste nach WN 5020.010 ist einzuhalten.
 Conformity with Wieland document WN 5020.010 e (list of prohibited / declarable hazardous substances) to be declared!

Freitoleranz nach General tolerance	CAD - Zeichnung, keine manuellen Änderungen CAD - drawing, no manual modifications allowed	1. Verwendung: First Use:	Blatt: 1 von 1 Sheet: of 1
Werkstoff/Material	2014 Tag/Date Name	Zeichnung Nr./Drawing No.	
Maßstab/Scale 1:1	gezeichnet/drawn 02.09. Treschan	T 46.031.4553.0 13K a	
Vol. mm ³ / Ofl./Surf. mm ²	geprüft/checked Normgepr. / Stand. check	Maße in mm/Dimensions are in mm	
Änderung/Revision	Ersatz für/Replacement for:	Benennung/Title	
a 06.10.2014/ Index Datum / Blatt Date / Sheet	www.wieland-electric.com	BUCHSENTE I L FA - mit Zugentlastung, 3-polig female, with strain relief, 3 poles	