

EU  
xComfort CSEZ-01/19

CSEZ-01/19

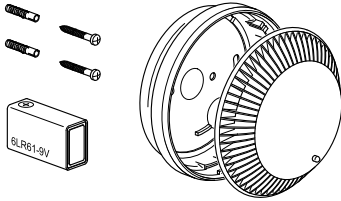

CSEZ-01/20

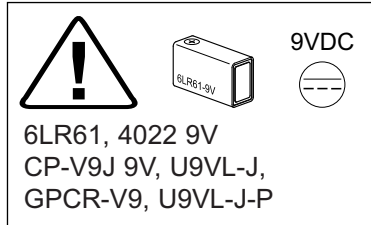

IP43

	T=-25°C - +70°C
	T=-10°C - +60°C
	Max. 60m <sup>2</sup> , Max. h=6m

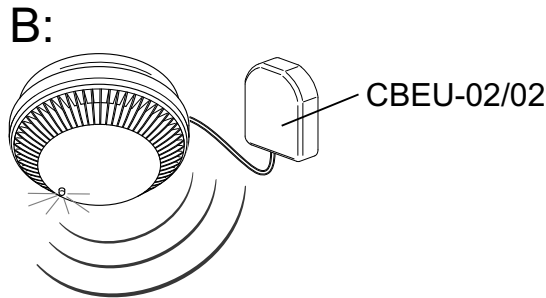
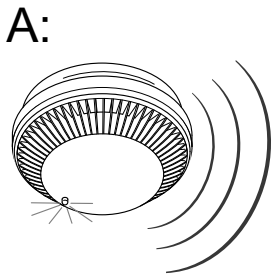

① ∅ 6mm

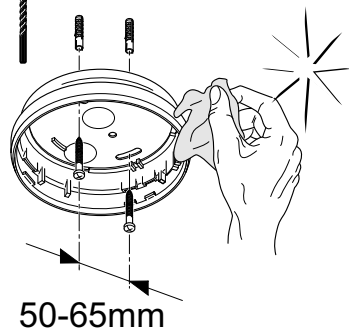

②

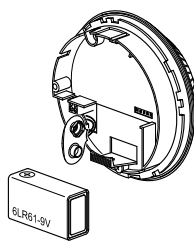

③

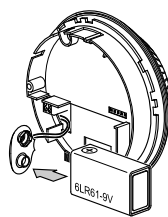

④

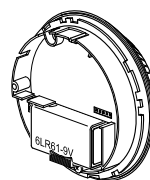

⑤

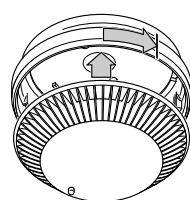

⑥ A:

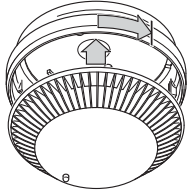

⑥ B:

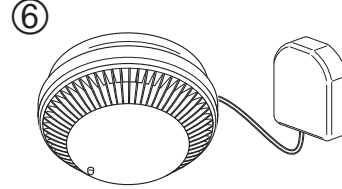
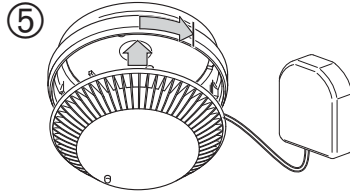
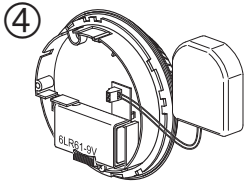
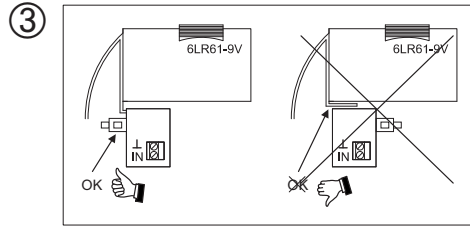
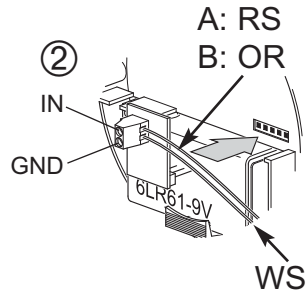
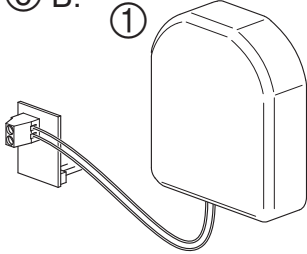



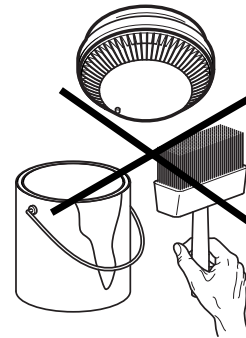
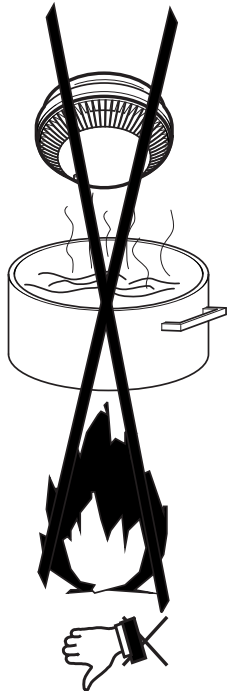
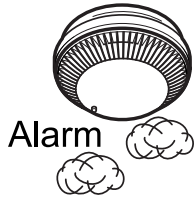

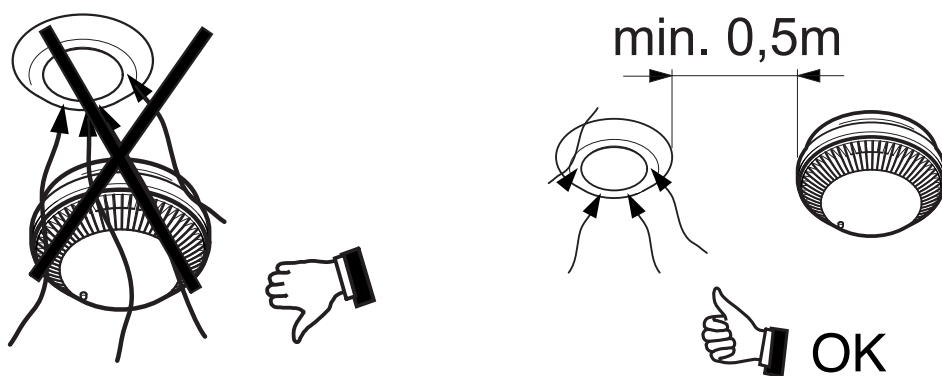
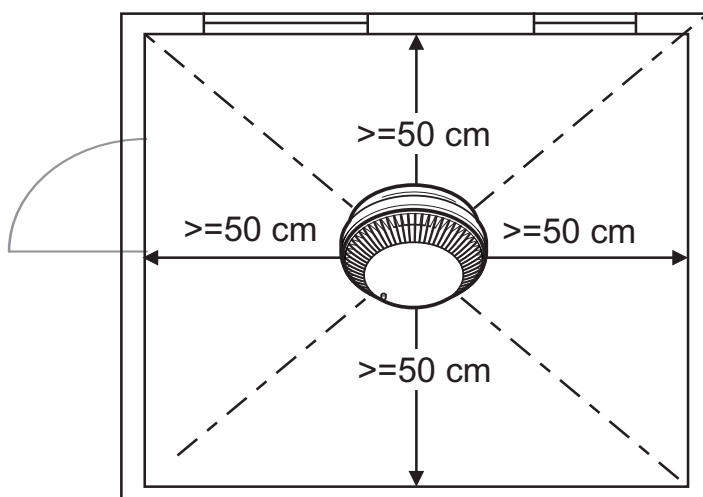
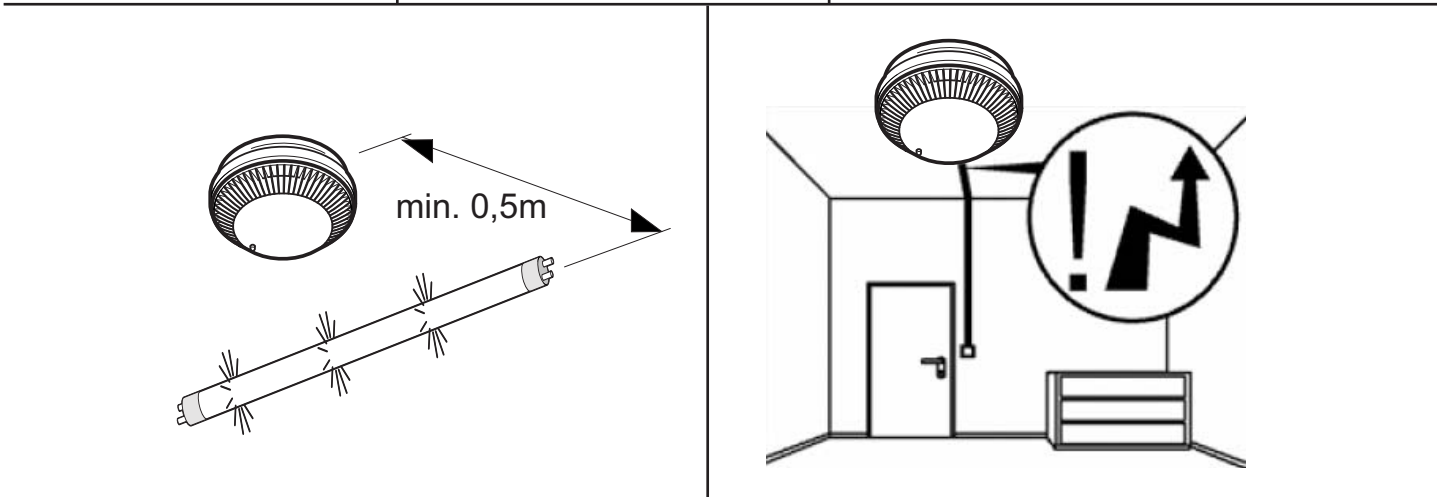
Mode M2!!!

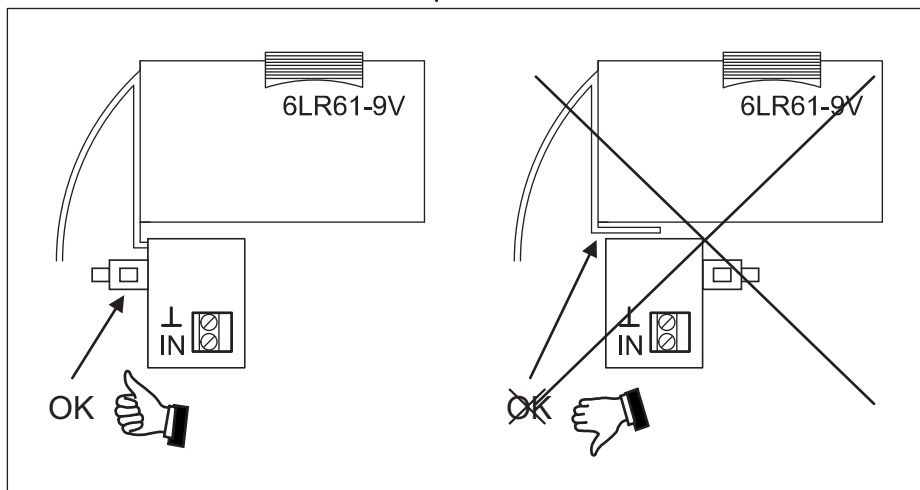
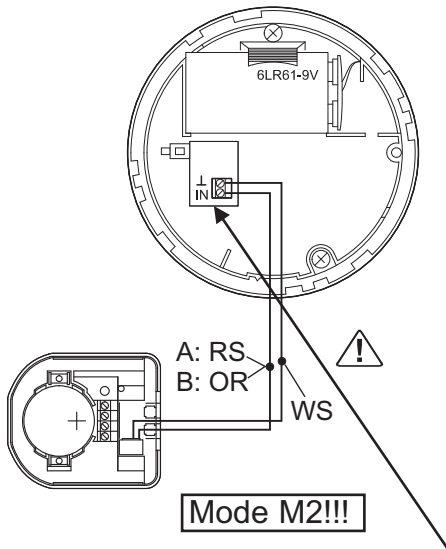
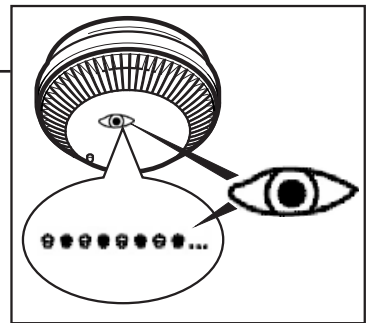
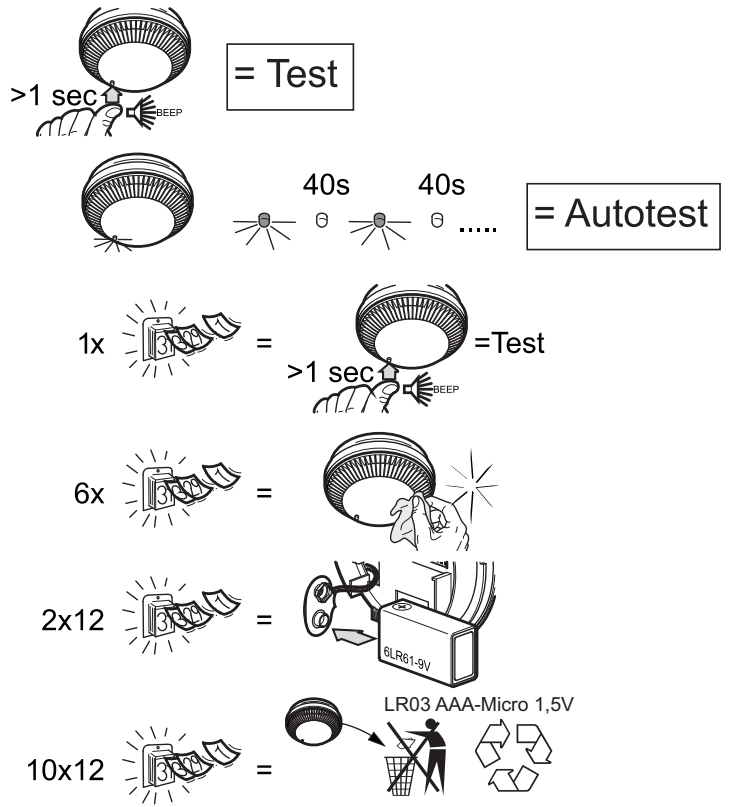
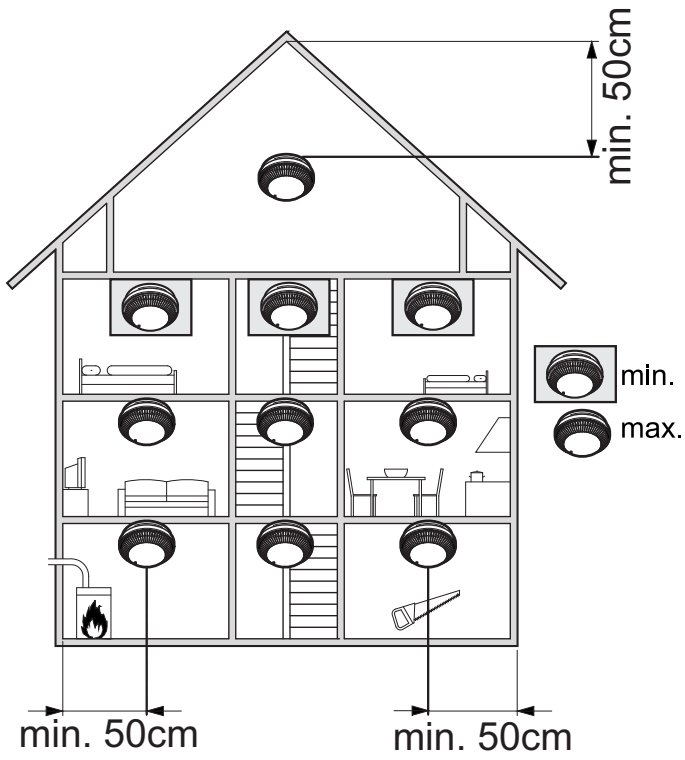

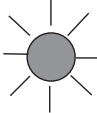
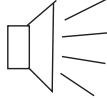
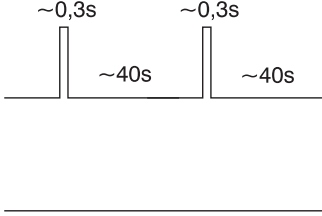
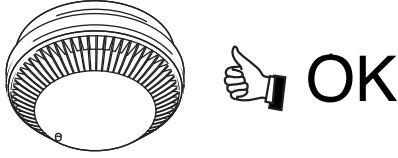
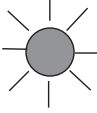
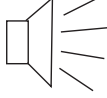
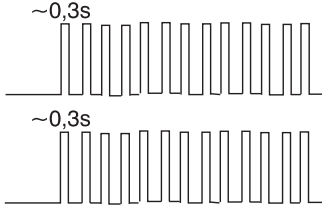

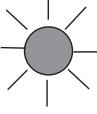
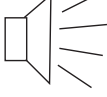
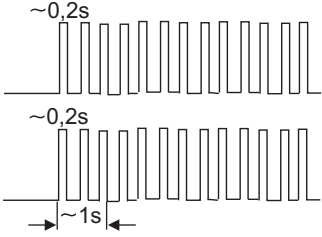
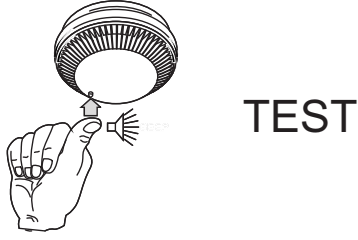
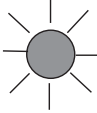
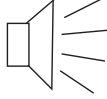
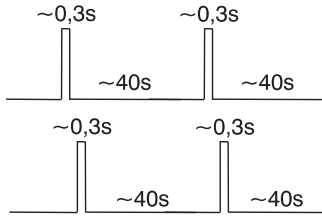
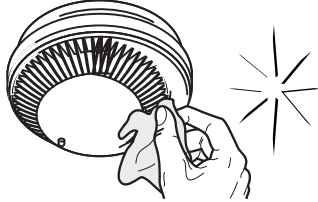
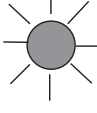
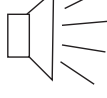
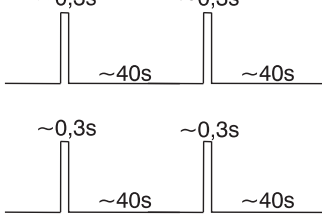
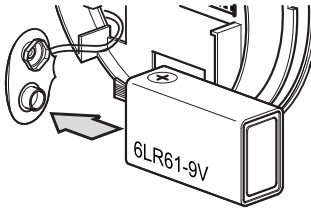
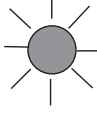
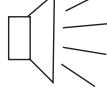

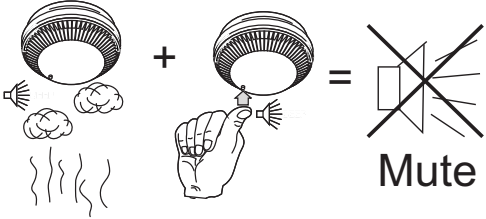
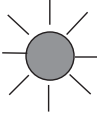
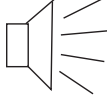
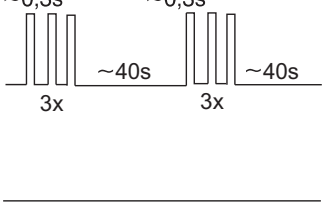
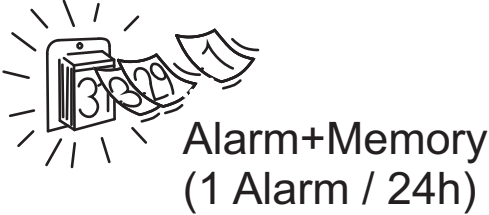
 LED  Beep		
 LED  Beep		
 LED  Beep		
 LED  Beep		
 LED  Beep		
 LED  Beep		
 LED  Beep		





# Declaration of Conformity

We, EATON Industries (Austria) GmbH  
3943 Schrems, Eugenia 1  
Austria

declare under our sole responsibility that the product (family)

## Eaton - Smoke Detector battery supplied

### CSEZ-01/19

(the declaration of conformity applies to all listed types within our actual product catalogue)

provided that it is installed, maintained and used in the application intended for, with respect to the relevant manufacturer's instructions, installation standards and "good engineering practices"

complies with the provisions of Council directive(s):

EMC Directive 2014/30/EU

RoHS Directive 2011/65/EU

based on compliance with following standard(s):

EN 14604:2005, EN 50130-4:2011, EN 61000-6-2:2005,  
EN 61000-6-3:2007+A1:2011, EN 50581:2012



17.11.2017

Fernando Ceccarelli

Senior Vice President  
General Manager

Friedrich Schröder

Director Quality  
& Systems

Affixing date of CE mark: 2006

Doc.Id.: CSEZ-0119\_171117

<p>RF- SYSTEM BASIC - MODE - CARD</p>																								
<table border="1"> <tr><td></td><td>CTAA-01/01</td></tr> <tr><td></td><td>CTAA-02/01</td></tr> <tr><td></td><td>CBEU-02/01</td></tr> <tr><td></td><td>CBEU-02/02</td></tr> <tr><td></td><td>M1 M2 M3 M4</td></tr> <tr><td></td><td>1x 2x 3x 4x</td></tr> <tr><td></td><td>CRCA-00/01</td></tr> <tr><td></td><td>CHSZ-00/01</td></tr> </table> <table border="1"> <tr><td></td><td>CSAU-01/01</td></tr> <tr><td></td><td>CJAU-01/01</td></tr> <tr><td></td><td>CDAU-01/01</td></tr> </table>		CTAA-01/01		CTAA-02/01		CBEU-02/01		CBEU-02/02		M1 M2 M3 M4		1x 2x 3x 4x		CRCA-00/01		CHSZ-00/01		CSAU-01/01		CJAU-01/01		CDAU-01/01		
	CTAA-01/01																							
	CTAA-02/01																							
	CBEU-02/01																							
	CBEU-02/02																							
	M1 M2 M3 M4																							
	1x 2x 3x 4x																							
	CRCA-00/01																							
	CHSZ-00/01																							
	CSAU-01/01																							
	CJAU-01/01																							
	CDAU-01/01																							

