

Part number

MAOS 24.32



Hood, EMC series, with 4 pegs, M32 side cable entry, size "104.27", high construction

Product description

Product type	Hood
Series	EMC
Closing type	With 4 pegs
Size	Size 104.27
Cable entry	Side cable entry M32
Specification	High construction

Technical data

IP degree of protection IP65 / IP66 / IP69

Further technical details

Weight	234,00 g
Operating temperature range (min, max)	-40°C...+125°C

Material properties

RoHs conformity	Compliant
China RoHs - EFUP	E
REACH SVHC substances	No

Approvals / Standards

Certifications	DNV, BV
UL	ECBT2
cUL	ECBT8

General ordering information

EAN13 code	8015747129671
eCl@ss 8.1	27440202
ETIM 7.0	EC000437

Packaging Information

Sub-packaging weight	0,23 kg
Sub-packaging description	Plastic packaging
Sub-packaging quantity	1 Pcs
Sub-packaging EAN barcode	8015747129725

Part number

MAOS 24.32



Catalogue drawings

CHOS (CAOS) - MHOS (MAOS)

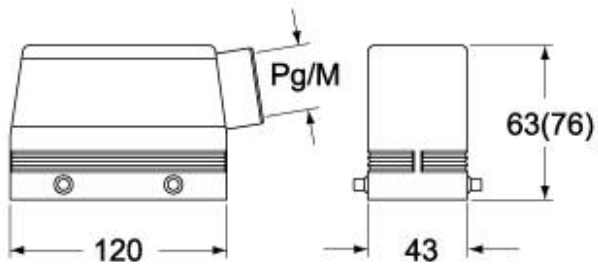

CHVS (CAVS) - MHVS (MAVS)

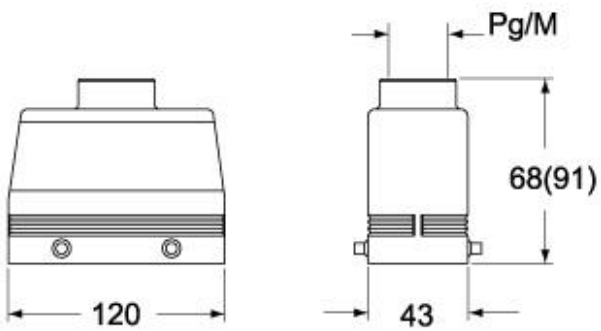

CHCS G

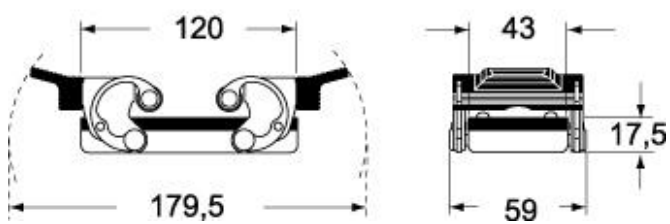

Notes

Dimensions shown in mm are not binding and may be changed without notice.