



**WTB4S-3P1165H**

W4

**MINIATURE PHOTOELECTRIC SENSORS**

**SICK**  
Sensor Intelligence.



Illustration may differ



### Ordering information

Type	Part no.
WTB4S-3P1165H	1086062

Other models and accessories → [www.sick.com/W4](http://www.sick.com/W4)

### Detailed technical data

#### Features

<b>Functional principle</b>	Photoelectric proximity sensor
<b>Functional principle detail</b>	Background suppression
<b>Sensing range max.</b>	4 mm ... 500 mm <sup>1)</sup>
<b>Sensing range</b>	10 mm ... 350 mm <sup>1)</sup>
<b>Emitted beam</b>	
Light source	PinPoint LED <sup>2)</sup>
Type of light	Visible red light
Light spot size (distance)	Ø 6.5 mm (150 mm)
<b>Key LED figures</b>	
Wave length	650 nm
<b>Adjustment</b>	Cable
<b>Special applications</b>	Hygienic and washdown zones
<b>Housing design</b>	Hygiene

<sup>1)</sup> Object with 90% remission (based on standard white, DIN 5033).

<sup>2)</sup> Average service life: 100,000 h at T<sub>J</sub> = +25 °C.

#### Safety-related parameters

<b>MTTF<sub>D</sub></b>	1,211 years
<b>DC<sub>avg</sub></b>	0 %
<b>T<sub>M</sub> (mission time)</b>	20 years

## Electrical data

<b>Supply voltage <math>U_B</math></b>	10 V DC ... 30 V DC <sup>1)</sup>
<b>Ripple</b>	< 5 V <sub>pp</sub> <sup>2)</sup>
<b>Current consumption</b>	30 mA <sup>3)</sup>
<b>Protection class</b>	III
<b>Digital output</b>	
Type	PNP
Switching mode	Light switching
Output current $I_{max}$	≤ 100 mA
Response time	< 0.5 ms <sup>4)</sup>
Switching frequency	1,000 Hz <sup>5)</sup>
<b>Circuit protection</b>	A, B, C <sup>6) 7) 8)</sup>

<sup>1)</sup> Limit values, reverse-polarity protected, operation in short-circuit protected network: max. 8 A.

<sup>2)</sup> May not exceed or fall below  $U_V$  tolerances.

<sup>3)</sup> Without load.

<sup>4)</sup> Signal transit time with resistive load.

<sup>5)</sup> With light/dark ratio 1:1.

<sup>6)</sup> A =  $V_S$  connections reverse-polarity protected.

<sup>7)</sup> B = inputs and output reverse-polarity protected.

<sup>8)</sup> C = interference suppression.

## Mechanical data

<b>Housing</b>	Rectangular
<b>Design detail</b>	Slim
<b>Dimensions (W x H x D)</b>	15.25 mm x 63.2 mm x 22.15 mm
<b>Connection</b>	Cable, 4-wire, 2 m <sup>1)</sup>
<b>Connection detail</b>	
Conductor size	0.14 mm <sup>2</sup>
Length of cable (L)	2 m <sup>1)</sup>
<b>Material</b>	
Housing	Stainless steel, Stainless steel V4A (1.4404, 316L)
Front screen	Plastic, PMMA
Cable	PVC
<b>Weight</b>	80 g

<sup>1)</sup> Do not bend below 0 °C.

## Ambient data

<b>Enclosure rating</b>	IP66 IP67 IP68 IP69K
<b>Ambient operating temperature</b>	-30 °C ... +70 °C <sup>1)</sup> -30 °C ... +60 °C
<b>Ambient temperature, storage</b>	-30 °C ... +75 °C

<sup>1)</sup> At  $U_V \leq 24$  V and  $I_A < 30$  mA.

<b>UL File No.</b>	FDA, UL No. NRKH.E181493 & cUL No. NRKH7.E181493
--------------------	--

<sup>1)</sup> At UV ≤ 24 V and IA < 30 mA.

### Classifications

<b>ECLASS 5.0</b>	27270904
<b>ECLASS 5.1.4</b>	27270904
<b>ECLASS 6.0</b>	27270904
<b>ECLASS 6.2</b>	27270904
<b>ECLASS 7.0</b>	27270904
<b>ECLASS 8.0</b>	27270904
<b>ECLASS 8.1</b>	27270904
<b>ECLASS 9.0</b>	27270904
<b>ECLASS 10.0</b>	27270904
<b>ECLASS 11.0</b>	27270904
<b>ECLASS 12.0</b>	27270903
<b>ETIM 5.0</b>	EC002719
<b>ETIM 6.0</b>	EC002719
<b>ETIM 7.0</b>	EC002719
<b>ETIM 8.0</b>	EC002719
<b>UNSPSC 16.0901</b>	39121528

### Connection type

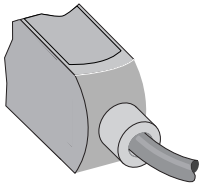

### Connection diagram

Cd-093

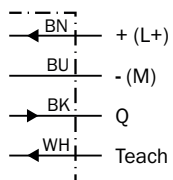

**Characteristic curve**

WTB4S-3, 500 mm

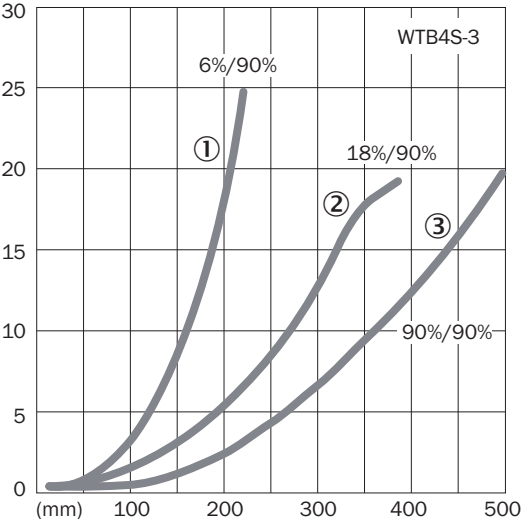

- ① Sensing range on black, 6% remission factor
- ② Sensing range on gray, 18% remission factor
- ③ Sensing range on white, 90% remission factor

**Sensing range diagram**

WTB4S-3, 500 mm

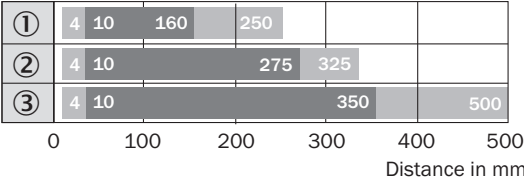

- Sensing range      ■ Sensing range max.
- ① Sensing range on black, 6% remission factor
- ② Sensing range on gray, 18% remission factor
- ③ Sensing range on white, 90% remission factor

**Dimensional drawing** (Dimensions in mm (inch))

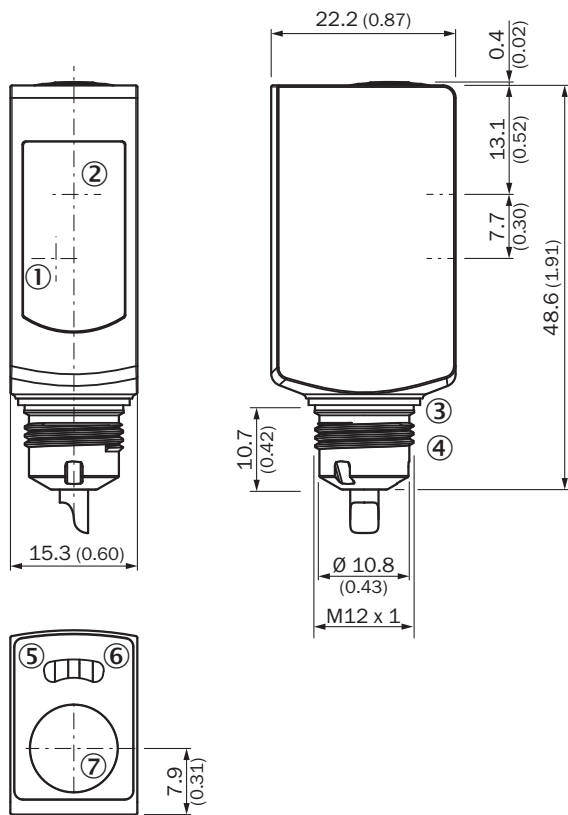

WTB4S-3H, WTF4S-3H, with single teach-in button



- ① Center of optical axis, receiver
- ② Center of optical axis, sender
- ③ Sealing ring (tightening torque 6 Nm)
- ④ Connector M12
- ⑤ LED indicator yellow: Status of received light beam
- ⑥ LED indicator green: Supply voltage active
- ⑦ Teach-in button

**Recommended accessories**

Other models and accessories → [www.sick.com/W4](http://www.sick.com/W4)

	Brief description	Type	Part no.
<b>Other mounting accessories</b>			
	Diameter 18 mm x 100 mm for W4S-3 Inox hygiene. Hygienic integration without holes and brackets. Cable run inside tube	BEF-MR18G-NA	4065853
<b>Plug connectors and cables</b>			
	<ul style="list-style-type: none"> <li>• <b>Connection type head A:</b> Male connector, M8, 4-pin, straight</li> <li>• <b>Description:</b> Unshielded</li> <li>• <b>Connection systems:</b> Screw-type terminals</li> <li>• <b>Permitted cross-section:</b> 0.14 mm<sup>2</sup> ... 0.5 mm<sup>2</sup></li> </ul>	STE-0804-G	6037323

## SICK AT A GLANCE

SICK is one of the leading manufacturers of intelligent sensors and sensor solutions for industrial applications. A unique range of products and services creates the perfect basis for controlling processes securely and efficiently, protecting individuals from accidents and preventing damage to the environment.

We have extensive experience in a wide range of industries and understand their processes and requirements. With intelligent sensors, we can deliver exactly what our customers need. In application centers in Europe, Asia and North America, system solutions are tested and optimized in accordance with customer specifications. All this makes us a reliable supplier and development partner.

Comprehensive services complete our offering: SICK LifeTime Services provide support throughout the machine life cycle and ensure safety and productivity.

For us, that is “Sensor Intelligence.”

## WORLDWIDE PRESENCE:

Contacts and other locations –[www.sick.com](http://www.sick.com)