



Product designation Star-delta starter
Product type designation BFA150

Electrical features

Maximum operating current ($\leq 440V$) A 230

Components

Contactor standard supplied BF15000A / BF15000A / BF8000A
Thermal relay standard supplied No
Thermal relay to purchase separately RF200
Auxiliary contact standard supplied BFX1020 / BFX1011 / BFX1011

Contact characteristics

IEC standard motor powers

230V	kW	75
400V	kW	132
440V	kW	132
500V	kW	160

Mechanical features

Weight g 7500

Dimensions

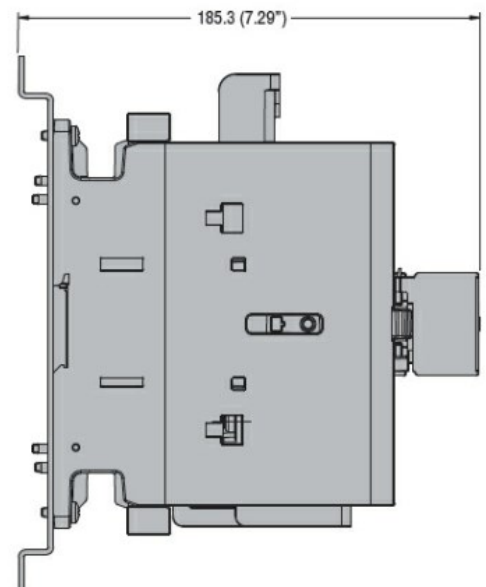
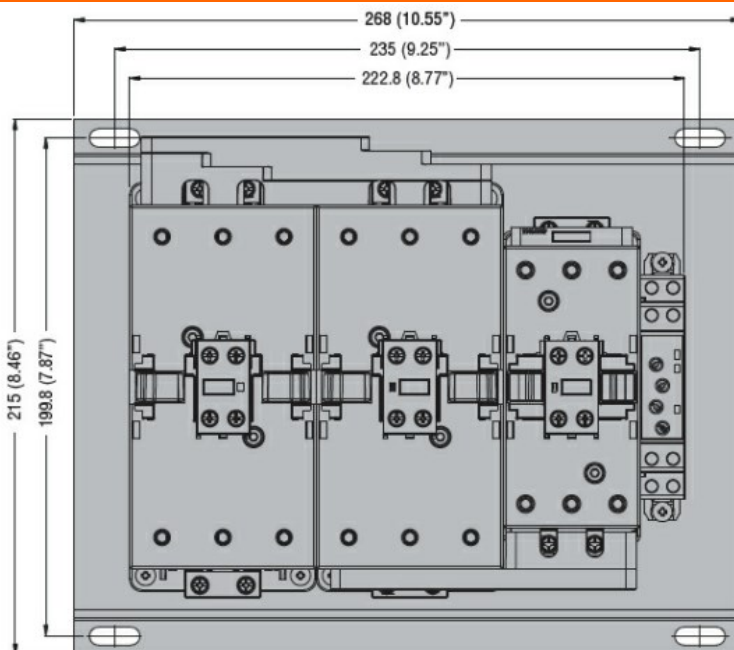

Wiring diagrams

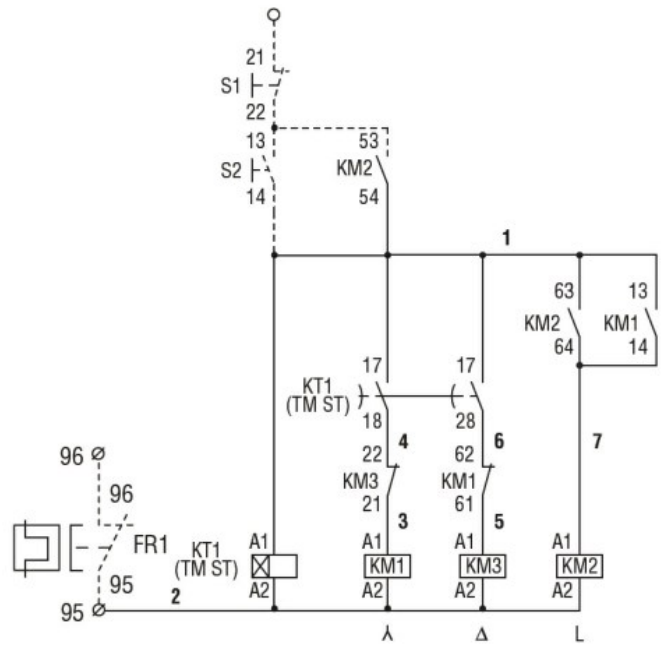
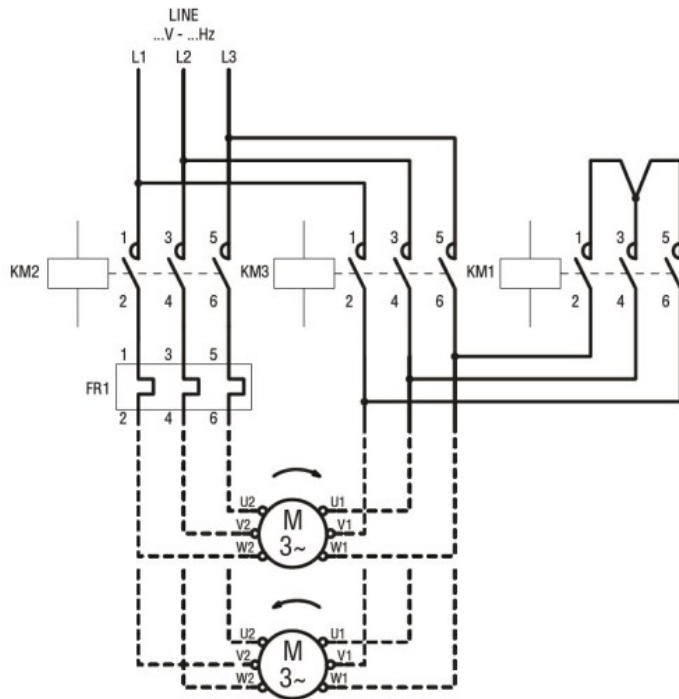

Certifications and compliance

Compliance

IEC/EN 60947-1
IEC/EN 60947-4-1

Certificates

/

ETIM classification

ETIM 8.0

EC001037 -
Motor
starter/Motor
starter
combination