



Signal tower
Ø70mm/2.75"
LTN70

Product designation

Product type designation

General characteristics

Diameter mm - inch 70 / 2.75

Material Plastic

Mechanical features

Weight g 94

Ambient conditions

Temperature

Operating temperature

min °C -30
max °C +50

Dimensions

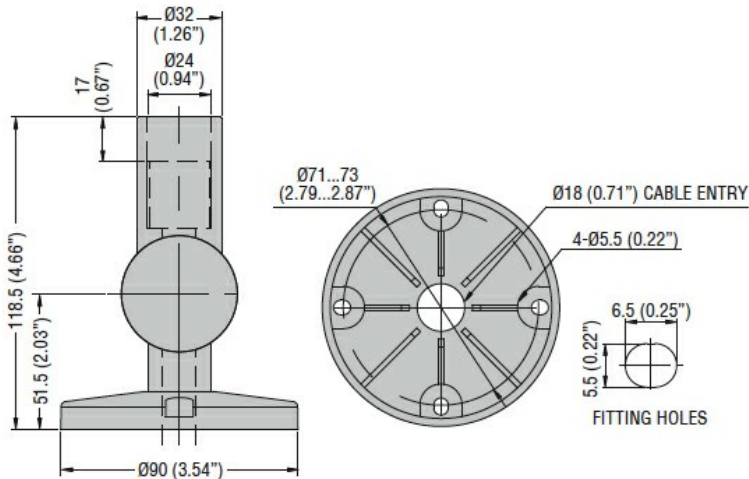

Certifications and compliance

Compliance

IEC/EN/BS 60947-1

IEC/EN/BS 60947-5-1

ETIM classification

ETIM 8.0

EC001153 - Wall
bracket for signal
tower