



# CLV630-6000

CLV63x

**FIXED MOUNT BARCODE SCANNERS**

**SICK**  
Sensor Intelligence.



### Ordering information

Type	Part no.
CLV630-6000	1041976

Other models and accessories → [www.sick.com/CLV63x](http://www.sick.com/CLV63x)



### Detailed technical data

#### Features

<b>Version</b>	Long Range
<b>Connection type</b>	Cable
<b>Reading field</b>	Oscillating mirror
<b>Sensor type</b>	Line scanner
<b>Optical focus</b>	Fixed focus
<b>Light source</b>	Light spot, laser, Visible, Red, 655 nm
<b>Light spot</b>	Circular
<b>Laser class</b>	2 (IEC 60825-1:2014, EN 60825-1:2014)
<b>Aperture angle</b>	≤ 50°
<b>Reading distance</b>	45 mm ... 659 mm <sup>1)</sup>
<b>Scanning frequency</b>	400 Hz ... 1,200 Hz
<b>Code resolution</b>	0.35 mm ... 1 mm
<b>Oscillating mirror functions</b>	Fixed (adjustable position)
Oscillation frequency	0.5 Hz ... 6.25 Hz
Angle of deflection	-20° ... 20°

<sup>1)</sup> For details see reading field diagram.

#### Mechanics/electronics

<b>Connection type</b>	1 x 15-pin D-Sub HD male connector (0.9 m)
<b>Supply voltage</b>	18 V DC ... 30 V DC
<b>Power consumption</b>	6 W
<b>Housing</b>	Aluminum die cast
<b>Housing color</b>	Light blue (RAL 5012)
<b>Window material</b>	Glass
<b>Enclosure rating</b>	IP65 (EN 60529)

<sup>1)</sup> At 25 °C.

<b>Protection class</b>	III (EN 61140)
<b>Weight</b>	420 g, with connecting cable
<b>Dimensions (L x W x H)</b>	95 mm x 107 mm x 41 mm
<b>MTBF</b>	100,000 h
<b>MTTF</b>	40,000 h (Laser diode) <sup>1)</sup>

<sup>1)</sup> At 25 °C.

## Performance

<b>Readable code structures</b>	1D codes
<b>Bar code types</b>	All current code types
<b>Code printing process</b>	Label (printed codes)
<b>Print ratio</b>	2:1 ... 3:1
<b>No. of codes per scan</b>	1 ... 20 (Standard decoder) 1 ... 6 (SMART decoder)
<b>No. of codes per reading interval</b>	1 ... 50 (auto-discriminating)
<b>No. of characters per reading interval</b>	5,000 500 (for multiplexer function in CAN operation)
<b>No. of multiple readings</b>	1 ... 99

## Interfaces

<b>PROFINET</b>	✓, RS-232, RS-422, RS-485
Type of fieldbus integration	Optional over external fieldbus module CDF600-2 Optional over external fieldbus module CDF600 Optional over external fieldbus module CDF600-2
Function	PROFINET Single Port, PROFINET Dual Port Data interface (read result output), Service interface SICK CAN sensor network CSN (CAN controller/CAN device, multiplexer/server)
Data transmission rate	2,400 Baud ... 115.2 kBaud, AUX: 57.6 kBaud (RS-232) 20 kbit/s ... 1 Mbit/s 20 kbit/s ... 1 Mbit/s
<b>Digital inputs</b>	4 ("Sensor 1", "Sensor 2", 2 inputs via optional parameter storage CMC600 in CDB620/CDM420)
<b>Digital outputs</b>	4 ("Result 1", "Result 2", 2 outputs via optional parameter storage CMC600 in CDB620/CDM420)
<b>Reading pulse</b>	Digital inputs
<b>Optical indicators</b>	6 LEDs (Ready, Result, laser, Data, CAN, LNK TX, Bar graph for displaying the reading rate percentage (10 LEDs))
<b>Acoustic indicators</b>	Beeper/buzzer (can be switched off, can be allocated as a result indication function)
<b>Control elements</b>	2 buttons (choose and start/stop functions)
<b>Configuration software</b>	SOPAS ET
<b>Memory card</b>	MicroSD memory card (flash card), optional

## Ambient data

<b>Electromagnetic compatibility (EMC)</b>	EN 61000-6-3 (2001-10) / EN 61000-6-2:2005
<b>Vibration resistance</b>	EN 60068-2-6 (1995)
<b>Shock resistance</b>	EN 60068-2-27 (1993)
<b>Ambient operating temperature</b>	0 °C ... +40 °C
<b>Storage temperature</b>	-20 °C ... +70 °C

<b>Permissible relative humidity</b>	90 %, Non-condensing
<b>Ambient light immunity</b>	2,000 lx, on barcode
<b>Bar code print contrast (PCS)</b>	≥ 60 %

General notes

<b>Note on use</b>	For Ethernet connection please use an Ethernet version of CLV6xx
--------------------	--

Classifications

<b>ECLASS 5.0</b>	27280102
<b>ECLASS 5.1.4</b>	27280102
<b>ECLASS 6.0</b>	27280102
<b>ECLASS 6.2</b>	27280102
<b>ECLASS 7.0</b>	27280102
<b>ECLASS 8.0</b>	27280102
<b>ECLASS 8.1</b>	27280102
<b>ECLASS 9.0</b>	27280102
<b>ECLASS 10.0</b>	27280102
<b>ECLASS 11.0</b>	27280102
<b>ECLASS 12.0</b>	27280102
<b>ETIM 5.0</b>	EC002550
<b>ETIM 6.0</b>	EC002550
<b>ETIM 7.0</b>	EC002550
<b>ETIM 8.0</b>	EC002550
<b>UNSPSC 16.0901</b>	43211701

Dimensional drawing (Dimensions in mm (inch))

CLV63x/64x/65x Standard, oscillating mirror

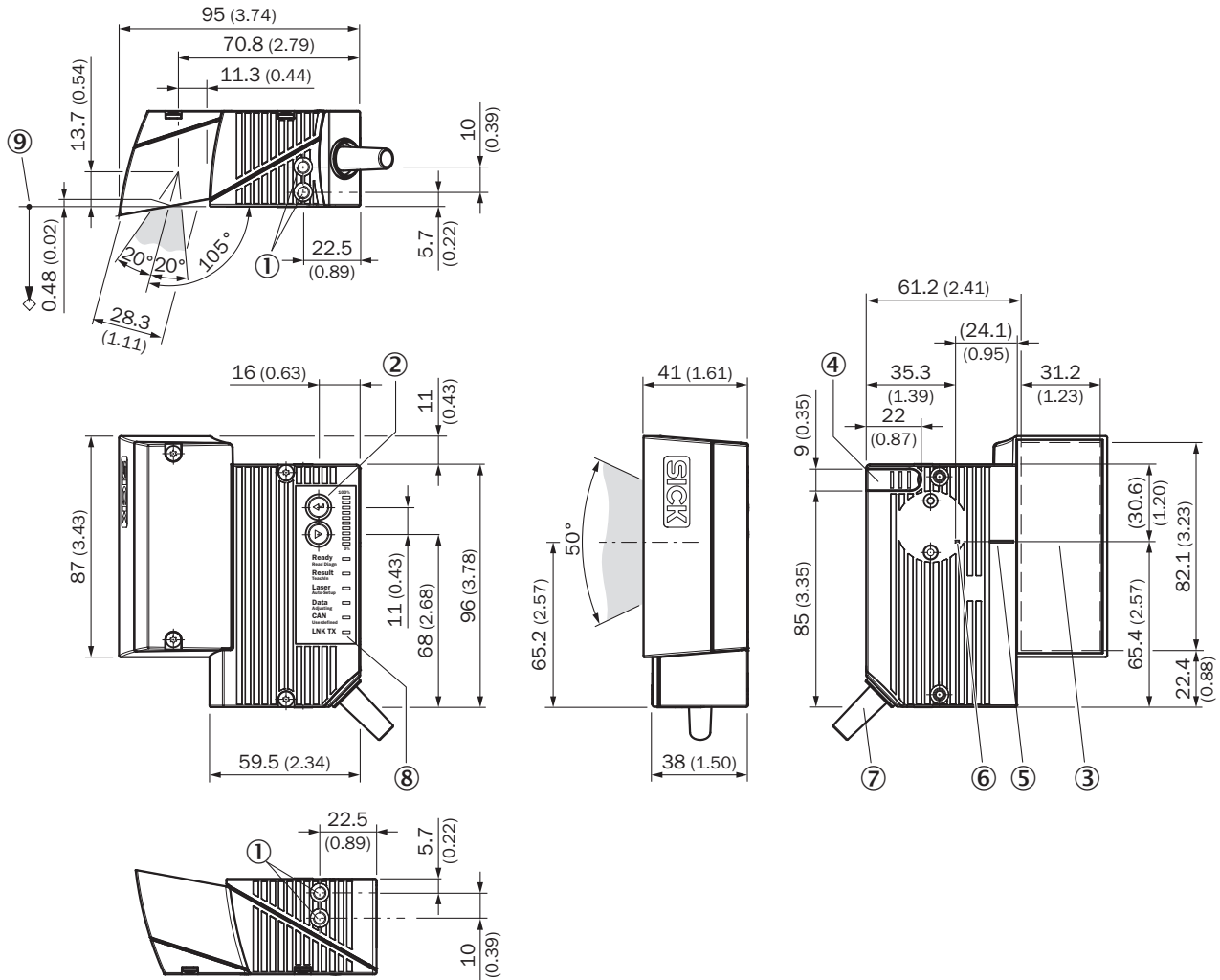

- ① Blind hole thread M5, 5 mm deep (2 x), for mounting
- ② Function button (2 x)
- ③ Reading field
- ④ Cover for the microSD memory card
- ⑤ Central position of the deflected laser beam in the V-shaped aperture angle
- ⑥ Internal impact point: rotation point of the variable direction laser beam
- ⑦ Cable with 15-pin D-sub HD male connector
- ⑧ LED status indicator (6x) and bar graph
- ⑨ Reference point for reading distance (from housing edge to object)

Reading field diagram

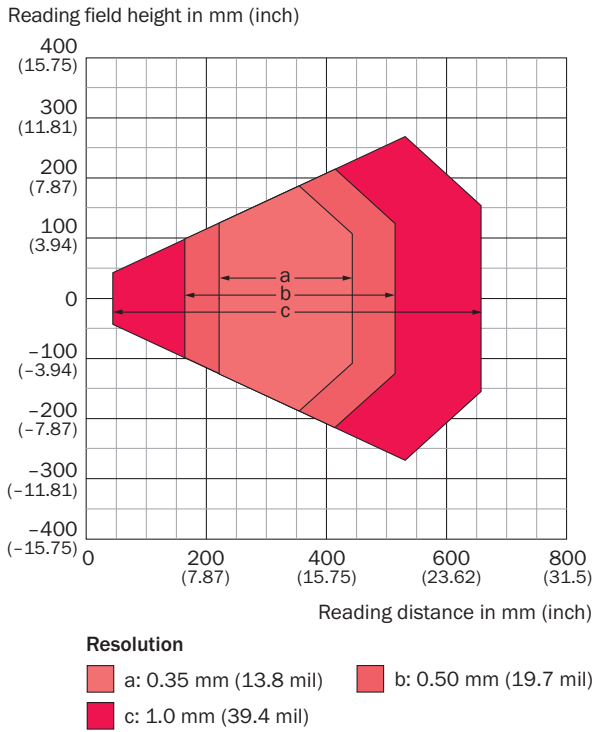



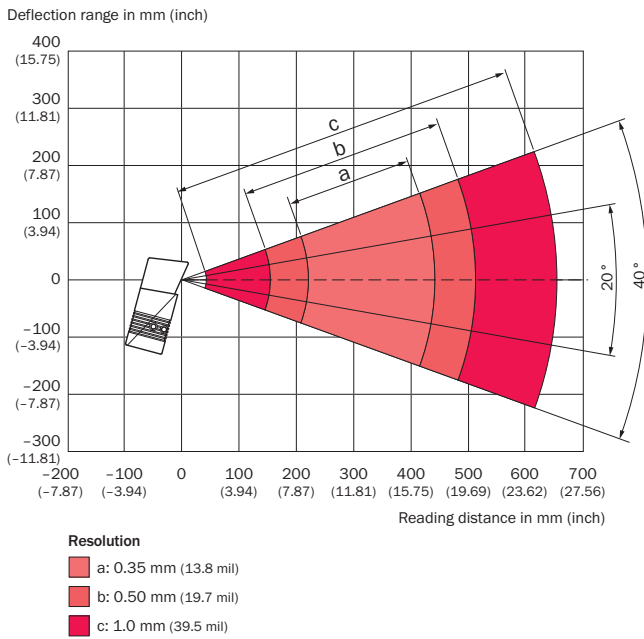

Deflection width



## Recommended accessories

Other models and accessories → [www.sick.com/CLV63x](http://www.sick.com/CLV63x)

	Brief description	Type	Part no.
Cloning modules			
	External parameter memory for integration in CDB620/CDB650/CDM42x	CMC600-101	1042259
Storage media			
	microSD memory card with 1 GB for industrial use	microSD memory card	4051366
Mounting brackets and plates			
	Hanger-shaped mounting bracket, mounting hardware included	Mounting bracket	2042800
Modules			
	<ul style="list-style-type: none"> <li>• <b>Sub product family:</b> CDB620</li> <li>• <b>Supported products:</b> CLV61x - CLV65x, Lector62x, RFH6xx, RFU62x</li> <li>• <b>Brief description:</b> Small connection module for one sensor, 4 cable glands, base for CMC600</li> </ul>	CDB620-001	1042256

## Recommended services

Additional services → [www.sick.com/CLV63x](http://www.sick.com/CLV63x)

	Type	Part no.
Performance check		
<ul style="list-style-type: none"> <li>• <b>Product area:</b> Fixed mount barcode scanners</li> <li>• <b>Range of services:</b> Inspection of defined functions, e.g., reading performance</li> <li>• <b>Travel expenses:</b> The prices do not include travel costs such as hotel, flight, travel time and expenses.</li> <li>• <b>Duration:</b> Additional work will be invoiced separately</li> </ul>	Performance check CLV4xx/CLV6xx	1682028
Commissioning		
<ul style="list-style-type: none"> <li>• <b>Product area:</b> Fixed mount barcode scanners</li> <li>• <b>Range of services:</b> Inspection of connection, fine adjustment, optimization of parameters of SICK product as well as tests, Setup of previously defined functions of reading configuration, code configuration, data processing and network, interfaces or inputs and outputs</li> <li>• <b>Travel expenses:</b> The prices do not include travel costs such as hotel, flight, travel time and expenses.</li> <li>• <b>Duration:</b> Additional work will be invoiced separately</li> </ul>	Commissioning CLV61x ... CLV64x	1681925
Extended warranty		
<ul style="list-style-type: none"> <li>• <b>Product area:</b> Identification solutions, machine vision, Detection and ranging solutions, safety camera sensors, Safety laser scanners, Safety radar sensors</li> <li>• <b>Range of services:</b> The services correspond to the scope of the statutory manufacturer warranty (SICK general terms of delivery).</li> <li>• <b>Duration:</b> Five-year warranty from delivery date.</li> </ul>	Extended warranty for a total of five years from delivery date	1680671

## SICK AT A GLANCE

SICK is one of the leading manufacturers of intelligent sensors and sensor solutions for industrial applications. A unique range of products and services creates the perfect basis for controlling processes securely and efficiently, protecting individuals from accidents and preventing damage to the environment.

We have extensive experience in a wide range of industries and understand their processes and requirements. With intelligent sensors, we can deliver exactly what our customers need. In application centers in Europe, Asia and North America, system solutions are tested and optimized in accordance with customer specifications. All this makes us a reliable supplier and development partner.

Comprehensive services complete our offering: SICK LifeTime Services provide support throughout the machine life cycle and ensure safety and productivity.

For us, that is “Sensor Intelligence.”

## WORLDWIDE PRESENCE:

Contacts and other locations –[www.sick.com](http://www.sick.com)