

► SKIMMER 15L PISCINA PREF. / SKIMMER 15L PREF. POOL

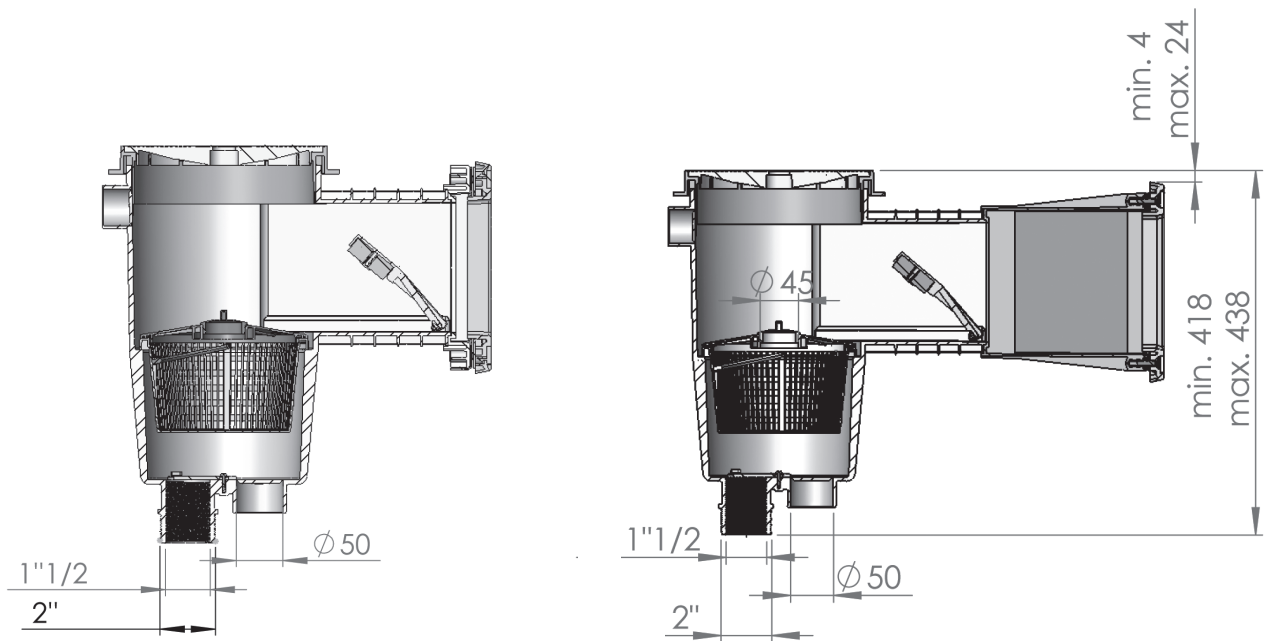



















DESCRIPCIÓN DEL PRODUCTO / PRODUCT DESCRIPTION

Todos los skimmers de la gama tienen tratamiento UV en las partes que no quedan enterradas. Fabricados en ABS blanco, con flotador de compuerta y clapeta para regulación de caudal. Conexión inferior de aspiración: rosca int. 1 1/2", ext. 2". Conexión simultánea al sumidero: ϕ int. 50. Conexión superior de evacuación de agua sobrante ϕ 40. Cesto recogehojas. Caudal recomendado 5 m³/h. Se recomienda instalar un skimmer por cada 25 m² de superficie de lámina de agua.

All exposed skimmer parts are UV resistant. In white ABS with silent wiew flap and flow regulation plug. 1 1/2" female - 2" male suction connections. ϕ 50 mm solvent connection also provided. Overflow connection ϕ 40 mm. Basket secured to base with bayonet fixing. Recommended flow 5 m³/h. We recommend installing one skimmer for every 25 m² of water surface area.

► CARACTERÍSTICAS TÉCNICAS / TECHNICAL CHARACTERISTICS

CARACTERÍSTICAS CHARACTERISTICS	01461	01462	01463	01464	06468	06469	06470*	06471	06472
Tipo de boca Type of throat									
Forma tapa Lid form									
Conexiones inferiores Bottom connections	1 ½" - 2"	1 ½" - 2"	1 ½" - 2"	1 ½" - 2"	1 ½" - 2"	1 ½" - 2"	1 ½" - 2"	1 ½" - 2"	1 ½" - 2"
Caudal recomendado Recommended flow rate	5 m ³ /h	5 m ³ /h	5 m ³ /h	5 m ³ /h	5 m ³ /h	5 m ³ /h	5 m ³ /h	5 m ³ /h	5 m ³ /h
Superficie recomendada Recommended surface	cada 25 m ² every 25 m ²	cada 25 m ² every 25 m ²	cada 25 m ² every 25 m ²	cada 25 m ² every 25 m ²	cada 25 m ² every 25 m ²	cada 25 m ² every 25 m ²	cada 25 m ² every 25 m ²	cada 25 m ² every 25 m ²	cada 25 m ² every 25 m ²
Insertos Inserts	✓	✓	✓	✓	-	-	-	-	-

*06470 sin juntas / without joints

► LOGÍSTICA / LOGISTICS

EMBALAJE Y PALETIZADO / PALLETIZED AND PACKAGING						
Código - Code	01461 - 01462 - 06471 - 06472			01463 - 01464 - 06468 - 06469 - 06470		
Medidas caja (mm) - Box sizes (mm)	a	b	c	a	b	c
	432	317	434	587	452	436
Unidades / Caja - Units / Box	1			1		
Volumen / Caja (m ³) - Volume / Box (m ³)	0,059			0,112		
Peso / Caja (Kg) - Weight / Box (Kg)	4			5,28		
Medidas palet (mm) - Pallet sizes (mm)	a	b	c	a	b	c
	1000	1200	2320	1000	1200	2300
Unidades / Palet - Units / Pallet	40			20		
Volumen / Palet (m ³) - Volume / Pallet (m ³)	2,784			2,748		
Peso / Palet (Kg) - Weight / Pallet (Kg)	168,56			114,16		

► CAJA / BOX

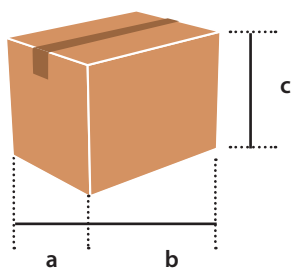

► PALET / PALLET

