

Part number

TMAO 16.32



Hood, T-TYPE series, with 4 pegs, M32 side cable entry, size "77.27"

Product description		Material properties	
Product type	Hood	Main material	Polypropylene (PP)
Series	T-TYPE	Colour	RAL 7012 grey
Closing type	With 4 pegs	RoHs conformity	Compliant
Size	Size 77.27	China RoHs - EFUP	E
Cable entry	Side cable entry M32	REACH SVHC substances	No
Technical data		Approvals / Standards	
IP degree of protection	IP65	UL	ECBT2
Further technical details		cUL	ECBT8
Further technical details		General ordering information	
Weight	130,00 g	EAN13 code	8015747168694
Operating temperature range (min, max)	-40°C ... +90°C	eCl@ss 8.1	27440202
		ETIM 7.0	EC000437
		Packaging Information	
		Packaging length	280,00 mm
		Packaging height	180,00 mm
		Packaging width	230,00 mm
		Packaging weight	2,84 kg
		Packaging volume	11,59 dm ³
		Packaging description	Carton box
		Packaging quantity	20 Pcs
		Packaging EAN code	8015747171168
		Sub-packaging weight	0,71 kg
		Sub-packaging description	Plastic packaging
		Sub-packaging quantity	5 Pcs
		Sub-packaging EAN barcode	8015747171175

Part number

TMAO 16.32



Catalogue drawings

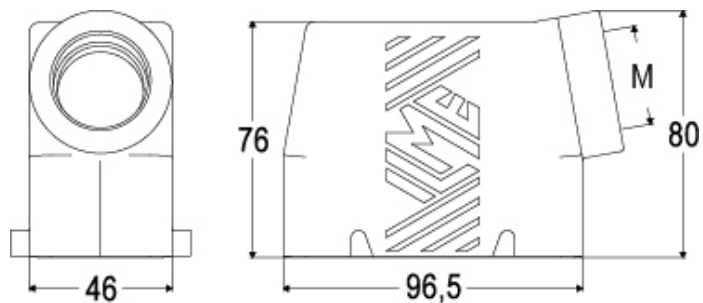

Notes

Dimensions shown in mm are not binding and may be changed without notice.
